

2020
2021

EXPORT PRICE LIST

Non-binding price
recommendations
for authorised dealers

**SHOWER
AND SOUL**

HÜPPE
SHOWER AND SOUL

HÜPPE Select+

Bathrooms can be planned. Life can't.



SELECT+ Tablet

Dear customers,

We are delighted that you take our products and services into consideration at your company and when advising your own customers.

The new 2020/21 price list will be of assistance to you here and demonstrates our space utilisation expertise in the area of shower screens, shower trays, wall coverings and accessories.

NEW: Find what you are looking for even more quickly with the **HÜPPE product configurator** at www.hueppe.com!

- The HÜPPE product configurator helps you to digitally identify the right models or a particular range for your customers quickly, allowing you to conveniently plan their shower areas online. Find just the right shower solution for the customer ranked according to the project budget.

You can look forward to all kinds of new and **innovative solutions** once again in 2020/21:

Select+ space utilisation concept

- We complete the shower area for you! With the **Select+ product range**, we offer you a highly attractive, **flexible** and **innovative space utilisation concept** comprising organisers and accessories that give you entirely new shower area planning and bathroom customisation options.
- Select+ is height-adjustable and is installed **without any drilling**, its height can be modified after bathroom installation and it can be complemented with other versions.
- **Orderliness can be fun** – for example with the new shower board or with the double profile that allows the practical Select+ organisers and accessories to be attached both inside and outside of the shower.

Combining Select+ with our EasyStyle back wall system

- We **connect the advantages** of two product ranges to create a top shower area solution for your customers. The EasyStyle wall covering profiles are now also available with the Select+ channel system, allowing the intelligent Select+ organisers to also be attached on the wall side without the need for any screws.
- With the new **profile colours that perfectly match the EasyStyle decors**, you can create impressive shower areas that look entirely homogeneous.

Colours used for customisation and modern design

- The trend in the direction of bathroom customisation continues unabated. We can offer you further **decors, some of which are exclusive**, from renowned designers and photo artists for the EasyStyle wall coverings.
- We are also offering new customisation options in the area of shower screens. Create first-class personalised shower areas with the **new galvanic colours** of the Studio range that make it even easier to match the materials and colours with high-quality bathroom fittings such as tapware

Explore new bathroom design avenues with us and realise the perfect bathrooms for your customers with HÜPPE shower areas.

Your satisfaction spurs us on and we look forward to working with you!

The HÜPPE team



NEW: HÜPPE Design pure

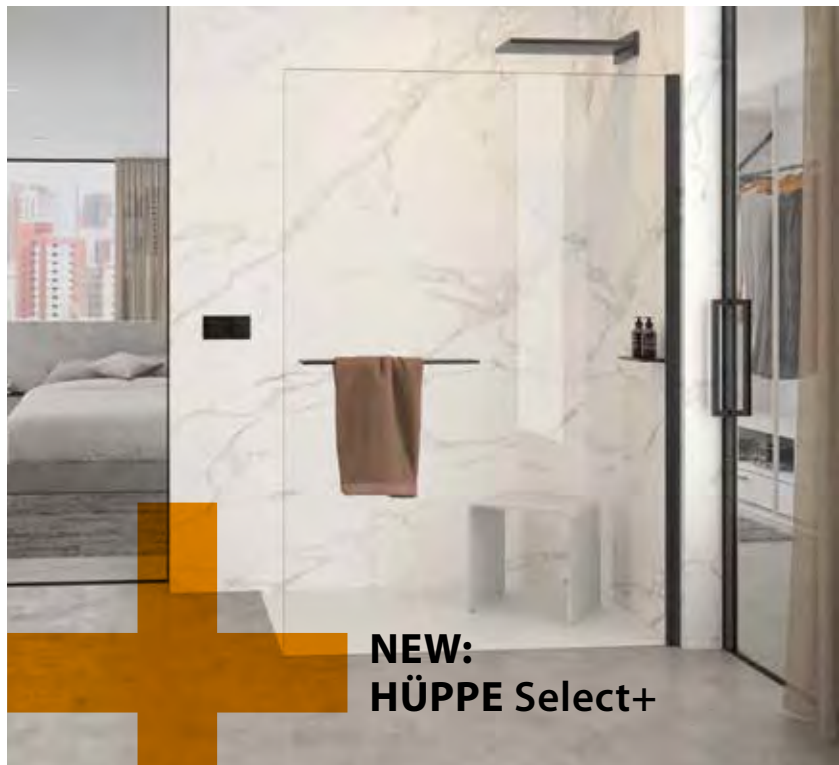

NEW: HÜPPE Select+

GENERAL INFORMATION

HÜPPE product configurator	7
What you should know	8
Definitions	9
Cleaning and care	10
Service and safety	11
Abbreviations	12
Pictograms	13
How to measure	17
Product range overview	18
Profile colours - Panel options - Handles	28



ACCESSOIRES & ORGANIZER SELECT+



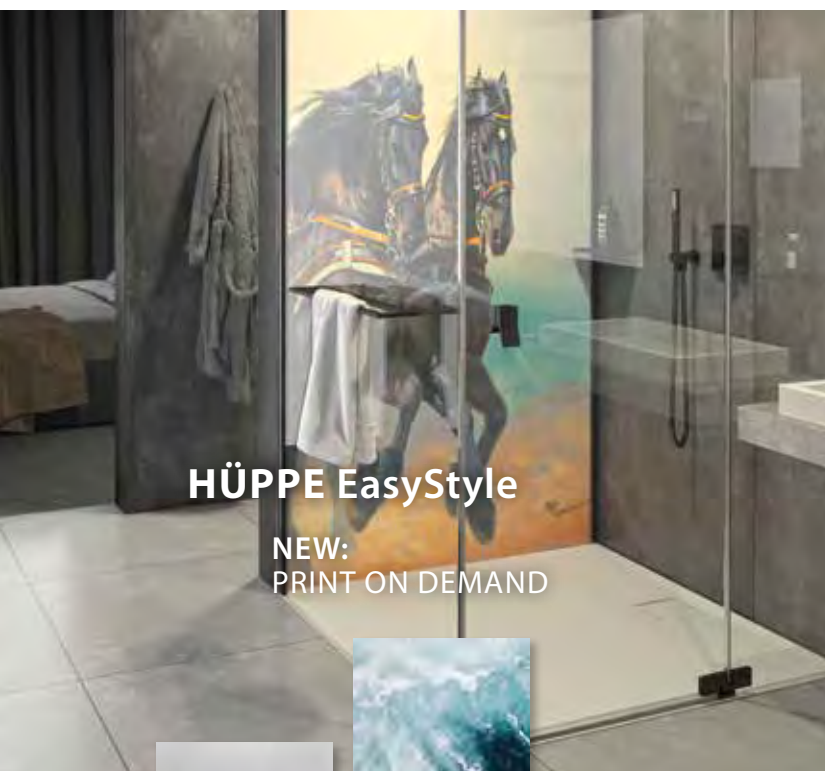

HÜPPE Shower trays	A
HÜPPE EasyStyle wall covering (set)	B
HÜPPE Select+	C
HÜPPE Alpha 2 fully framed / partially framed	D
HÜPPE Classics 2	E
HÜPPE Aura elegance	F
HÜPPE Design elegance / HÜPPE Design pure including U-shaped enclosure	G
HÜPPE 501 Design elegance swing doors including U-shaped enclosure	H
HÜPPE Enjoy elegance / HÜPPE Enjoy pure frameless	I
HÜPPE Enjoy elegance / HÜPPE Enjoy pure partially framed	J
HÜPPE Solva pure frameless including U-shaped enclosure	K
HÜPPE Solva pure partially framed including U-shaped enclosure	L
HÜPPE Xtensa pure	M
HÜPPE Refresh pure	N
HÜPPE Vista pure frameless	O
HÜPPE Vista pure partially framed	P
HÜPPE Studio Paris elegance / HÜPPE Studio Berlin pure frameless	Q
HÜPPE Studio Paris elegance / HÜPPE Studio Berlin pure partially framed	R
HÜPPE Walk-In models	S
HÜPPE Bath-top shower screens	T
HÜPPE Accessories / Accessory kit / Spare Parts / Shape of cross-section	Z

HÜPPE product configurator

Make it easy!

The new HÜPPE product configurator is a helpful tool for your everyday work. In a few clicks you can find the ideal product solution for your customers, quickly work out the price or immediately get all the relevant installation information. Take advantage of the following core functions:

- **Fast filtering of suitable solutions:** Starting with the spatial situation, use a few features to filter out suitable solutions for your customers.
- **All the relevant information in one place:** Get all the information you need for your everyday work directly with the product - product numbers, price, fitting variants, technical drawings, CAD files or spare parts catalogue.
- **No notes necessary:** Generate a PDF of the configured product in no time, including all relevant information for ordering and installation.
- **No more lengthy searching through price lists:** Enter the product number directly, select the desired size, profile colours, panel options, and immediately get the relevant price.

Just click: You will find the configurator (including product prices) in your professional account at www.hueppe.com or without price information at configurator.hueppe.com

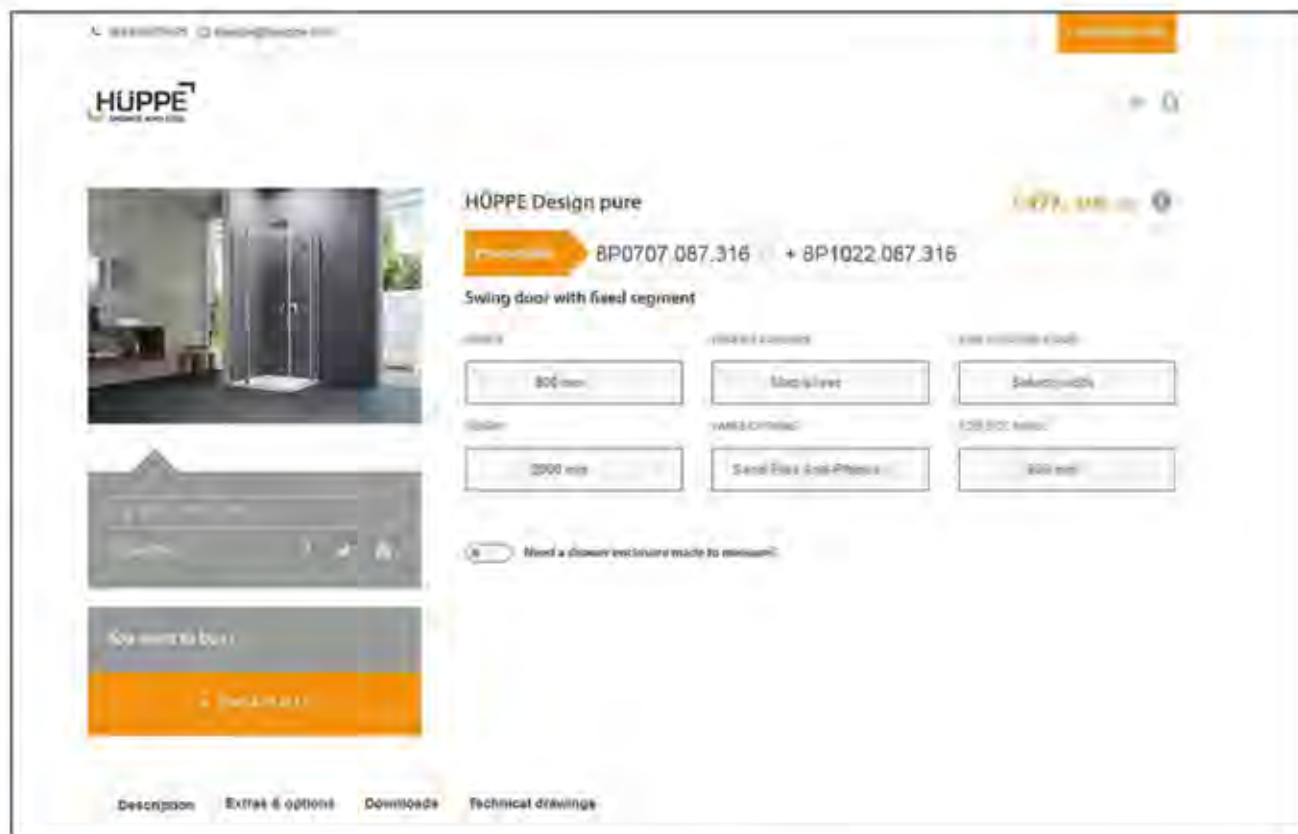

To create the item number:

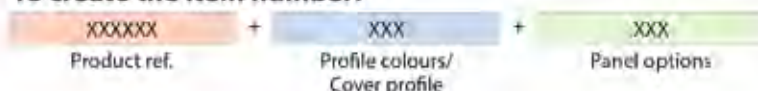

What you should know...

Water-tightness of shower enclosures

The trays must meet the requirements of **DIN EN 14428**. This involves testing the water-tightness in two test processes (see www.hueppe.com). According to the standard, shower enclosures must offer protection from spray water. Some small droplets of water outside of the shower enclosure are permitted.

Obviously, all HÜPPE shower enclosures meet this standard. However, there are differences in the water-tightness depending on the design of the shower enclosure. Hence the water-tightness requirements need to be clarified in the consultation meeting.

As a general rule, remember that fully-framed shower enclosures guarantee better water-tightness than partially framed or frameless enclosures. When choosing your door system, note that doors that open out into the room can drip onto the floor, whereas sliding doors ensure the water remains in the tray.



Shower enclosure with high profile



High degree of water tightness

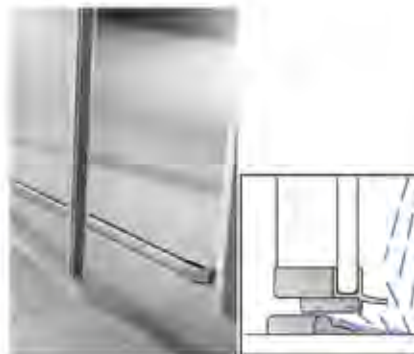

Shower enclosure with low profile or drip deflector strip



Middle degree of water tightness

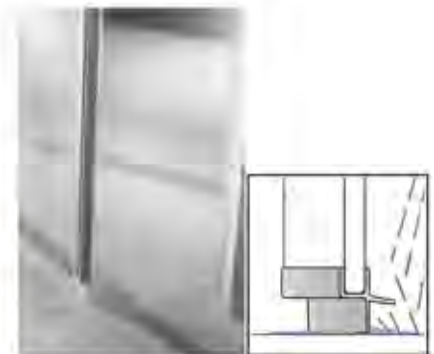

Shower enclosure with no profile or drip deflector strip



Lowest degree of water tightness

Installation instructions for chrome surfaces

Do not install shower enclosures with chrome profiles in areas where there is chlorine in the air (e.g. in public swimming baths or private swimming pools). The following installation instructions must always be observed: Avoid impact damage, do not use any metal tools, do not scratch or cut the profile surface with sharp instruments, and do not use silicone containing acetic acid. The choice of the correct silicone to use should be left to the installer, although we recommend the use of silicone for marble.



Quality is, and remains, our overriding concern

Load tests developed in conjunction with approved testing bodies are carried out daily. This ensures the highest standards are maintained. It goes without saying that all HÜPPE shower enclosures are tested according to the latest German TÜV guidelines and possess the TÜV-GS certificate. In addition, all HÜPPE products undergo rigorous internal testing that far exceeds the standards stipulated for the various door systems.

Definitions

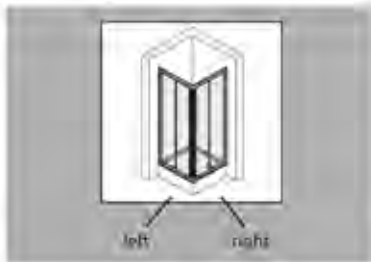

Where is left and where is right?

If you wish to order a swing door with a left-hand wall fixing, or an asymmetric shower enclosure with a tray installation dimension of 800 x 1200, it is important to keep the bigger picture in mind. This is why HÜPPE measures a shower from a viewpoint outside the enclosure. This gives a left-to-right design, as shown in the diagram.



Anti-Plaque glass

HÜPPE Anti-Plaque is a surface finish applied in the factory that simplifies cleaning and lets water run off easily. The result – fewer dirt and limescale deposits. Anything that does remain can simply be wiped off without the need for abrasive cleaning agents.



Folding sliding doors from HÜPPE

With many of HÜPPE's sliding doors, the individual panels can be unhooked from the lower guide rails and pushed inwards to make cleaning a breeze. In addition, most sliding door systems do not have a horizontal profile, thus avoiding dirty edges.

Cleaning and care

“What is the easiest way to clean my shower?”



Care instructions for chrome surfaces, mirror glass and wall coverings

These surfaces can be cleaned using water and soap suds. Best cleaning results will be achieved using TOP PLUS. After cleaning, wipe dry with a leather cloth. Cleaning agents and disinfectants containing alcohol, chlorine or acid must not be used under any circumstances. Abrasive or scouring cleaners are also unsuitable for use.



Glass cleaning instructions

Glass is generally easier to clean than acrylic surfaces. However, as drops of water and limescale deposits are easier to see on glass surfaces, they have to be cleaned regularly. We recommend TOP PLUS for cleaning safety glass showers.



Care instructions for Anti-Plaque glass

As the water flows off so quickly, hardly any dirt or limescale deposits can form. Anything that does remain can simply be wiped off without the need for abrasive cleaning agents. Under no circumstances should abrasive cleaners be used. TOP PLUS cleans gently and easily.



Acrylic cleaning instructions

Acrylic may not appear to be dirty. It should however be thoroughly cleaned occasionally using HÜPPE FLIP.



Care instructions for shower trays

The shower tray should be thoroughly cleaned with HÜPPE TOP cleaning agent from time to time.

Service and safety

“What type of service can I expect?”



10 year parts availability guarantee

As a manufacturer of branded products, HÜPPE provides a first class service. Every wearing part can be replaced – in exactly the same form as you purchased it. We offer a 10 year “availability guarantee” on wearing parts. This guarantee covers the following: HÜPPE will ensure that customers are able to purchase wearing parts for HÜPPE products for 10 years and have them delivered at home. The most convenient method to order the parts is to use our online spare parts shop by following the links on www.hueppe.com.

The guarantee period commences on the day the customer purchases the HÜPPE product. This parts availability guarantee does not affect your legal rights.



Sustained performance for your safety glass shower

HÜPPE sets new standards: Always offering our customers the highest quality is a fundamental component of our business philosophy. HÜPPE Anti-Plaque – tested and certified by TÜV Rheinland – is yet another clear demonstration of this quality standard. The certification procedure of TÜV Rheinland (standard 2 PFG 1921/06.11) includes the following tests:

- UV resistance
- Chemical resistance
- Thermal shock resistance
- Mechanical resistance
- Adhesion properties (adhesion of dirt)

Based on this simulation, the durability test confirmed a service life of at least 10 years.

Improper use of the shower or improper treatment of the Anti-Plaque surface finish may result in a reduction or permanent loss of the Anti-Plaque effect – irrespective of any damage to the glass surface itself.

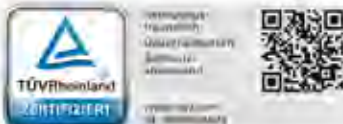

Abbreviations

What do "PT" and "SWK" mean?

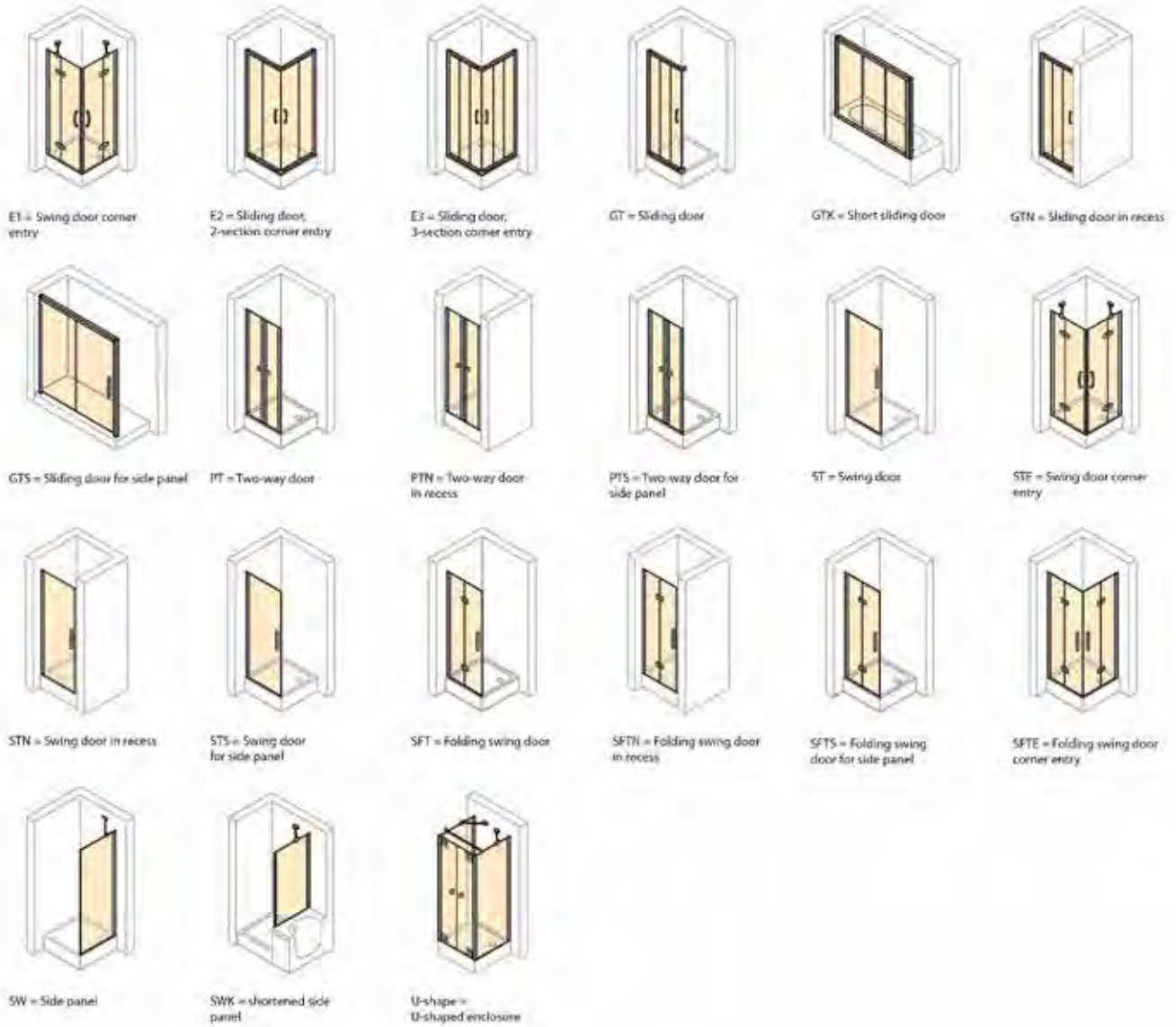

Pictograms

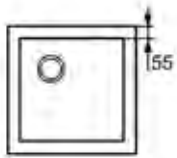

Rectangular - rim of tray: 55mm (current)

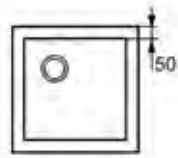

Rectangular - rim of tray: 50mm (current)

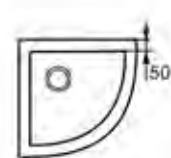

Quadrant - rim of tray: 50mm (current)

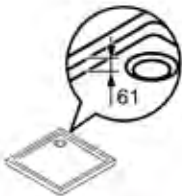

Depth: 61mm



Depth: 26mm

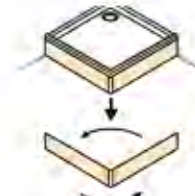

Front panel can be installed left or right handed.

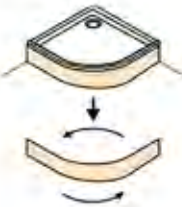

Front panel can be installed left or right handed.

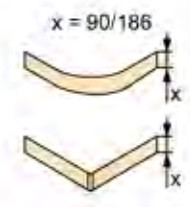

Height of front panel: 90/186mm

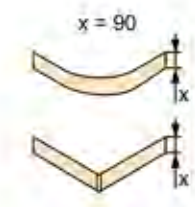

Height of front panel: 90mm



Shower tray with anti-slip finish.

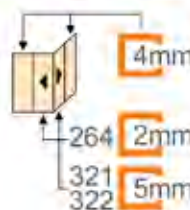

Styrene 2mm
Glass Door 5mm
Fixed panel 8mm

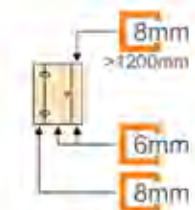

Glass 6mm
Additional section >1200mm: 8mm
Fixed panel 8mm

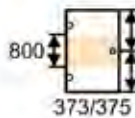

373/375 Privatima glass - height of sandblasted surface 800mm, centred under consideration of unit height with respect to unit height.

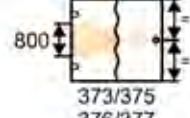

Glass 373/375 Privatima and glass 376/377 Bubbles - height sandblasted area 800mm, position central relative to unit height.

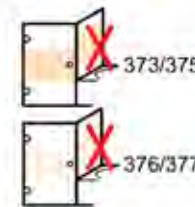

Glass 373/375 Privatima and glass 376/377 Bubbles not possible for made-to-measure on bathtub.



373/375 Privatima not possible for made-to-measure units on bathtubs.



Height of the chrome decal is 1338mm (tolerance: ± 2mm).

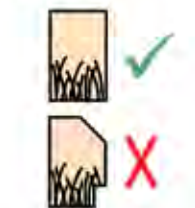

Chrome decal: Slopes and cut-outs not possible.

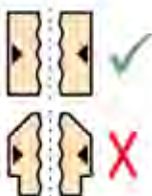

Slopes and cut-outs not possible.

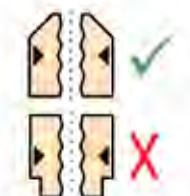

Cut-out not possible.

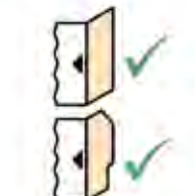

Slopes and cut-outs only possible in side panel (included in base price).



Slopes at the top or right-angled cut-outs at the bottom are possible in the fixed segment only.



Sloping cuts for a sloping ceiling at the top or right-angled cut-outs at the bottom in the fixed segment and the side panel are possible.



Sloping cuts at the top for a sloping ceiling or right-angled cut-outs at the bottom in the additional section are possible.

Pictograms



Sloping curb at the top for a sloping ceiling or right-angled cut-outs at the bottom in the side panel are possible.

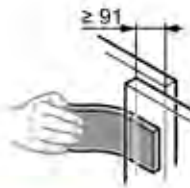

Overlap area of the panels at least 91mm. Special clearing aids for this area are included in scope of delivery.



180 degree hinge.



All sections movable.

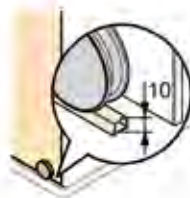

The bottom roller bar for the movable segment has a height of 10mm.

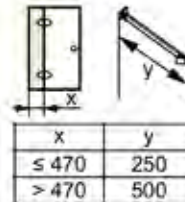

Fixed panel > 470 mm, stabiliser 500 mm.

Fixed panel ≤ 470 mm, stabiliser 250 mm.



Base height: 55-200mm possible.



Includes drip deflector strip.

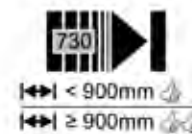

We recommend using Soft-Open/Soft-Close for widths from 900mm per side.



We recommend using Soft-Open/Soft-Close for widths from 1600mm per side.

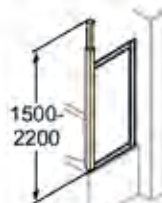

Ceiling support 1500-2200mm.

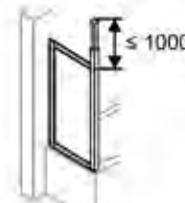

Ceiling support max. 1000mm.

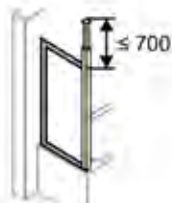

Ceiling support max. 700mm.



Ceiling support can be used left/right.



Fastening with two cross-bracings.



Cross-bracing can be shortened as required.

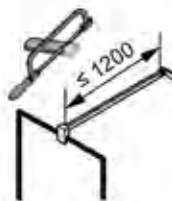

Length of cross bar: 1200mm / can be shortened as required.

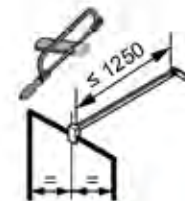

Length of cross bar: 1250mm / can be shortened as required. Always installed at the centre of the entire unit (dimension Y).



Length of cross bar: 1500mm / can be shortened as required.



Length of cross bar: max. 1200mm.

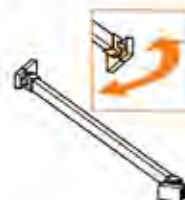

Stabilizer is variably adjustable.

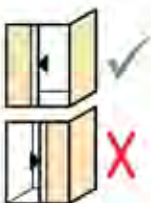

Side panel installed on door side.

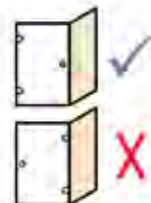

Side panel is fitted on handle side.

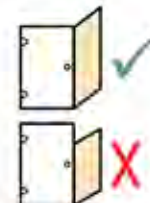

Door and side panel must have the same height.

Pictograms



Can be installed left or right handed.

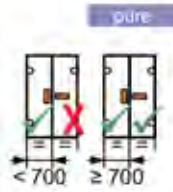

Horizontal installation of the handle is not possible with a width $< 700\text{mm}$.

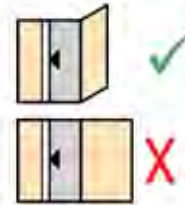

Cannot be used in-line to the door.

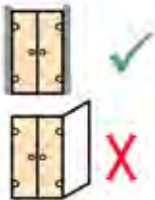

Cannot be combined with side panel.

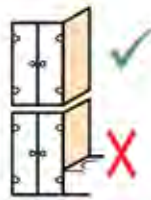

Cannot be combined with shortened side panel.



Shortened side panel not available.



Not possible as a U-shaped enclosure.

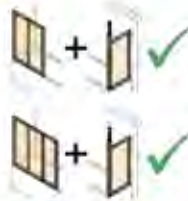

Can be combined with the models HÜPPE Combiner: 2 lath top shower screen, 2 panel and 3 panel.

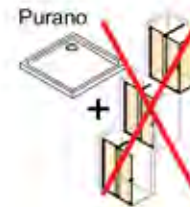

Not possible in combination with HÜPPE Purano shower tray.

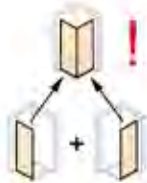

NOTE: The complete corner entry consists of two item nos.



Cross bar for side panel is supplied with two-way door.

How to measure

Installation on a shower tray:

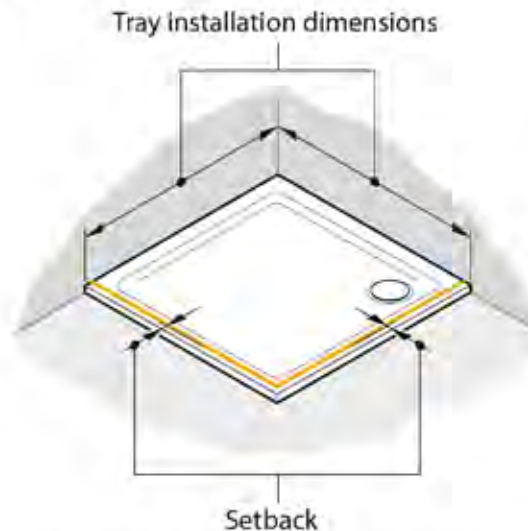

Doors and side panels are always installed with a setback to the tray edge. The dimensions ordered always correspond to the tray installation dimensions of the shower tray. Please take the measurement dimension details from the outline drawings on the relevant price list pages (see example on the right). With custom products, please always specify the **"000" reference (tray installation dimensions)** with your order.

Installation without shower tray:

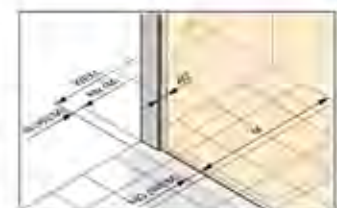
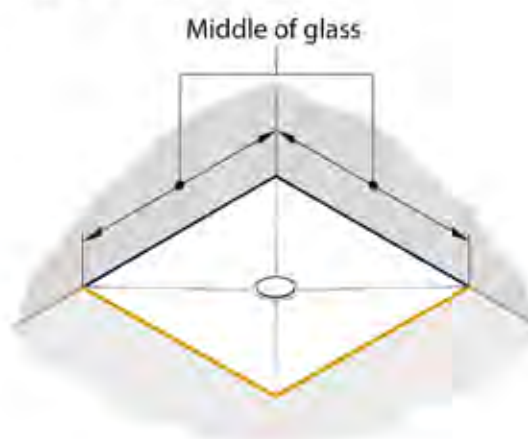

Standard item:

With standard items, the size given is always the dimensions of the shower tray. The dimensions of the shower tray are smaller by the setback applicable for the series. Please take the measurement dimension details from the outline drawings on the relevant price list pages (see above right example). With made-to-measure products, please always specify the **"001" reference (middle of glass dimensions)** with your order. The item will then be manufactured according to your wishes, e.g. middle of joint.

Installation dimensions (e.g. floor-flush)

Many HÜPPE products are already offered in the installation dimensions (M - middle of glass) as standard. Here the ordered dimensions = tile dimensions. When doing this, look out for products with the "Installation dimensions (e.g. floor-flush)" label. Please take the measurement dimension details from the outline drawings on the relevant price list pages (see lower right example). With custom products, please always specify the **"001" reference (middle of glass dimensions)** with your order.

Product range overview - Sliding doors - Corner solutions

	Alpha fully framed	Alpha 2 fully framed (1/2)	Alpha 2 partly framed	Alpha 2 partly framed (1/2)	Classics 2	Classics 2 EasyEntry	Classics 2 (1/2)	Classics 2 EasyEntry (1/2)	Aura	Design	Vista frameless	Vista partially framed	Xtensa (1/2)
--	--------------------	----------------------------	-----------------------	-----------------------------	------------	----------------------	------------------	----------------------------	------	--------	-----------------	------------------------	--------------

Rectangular - Sliding door, 2-section corner entry

Page	D.4-D.5	D.6-D.7	D.20-D.21	D.22-D.23	E.6-E.7	E.18-E.19	E.8-E.9	E.20-E.21	F.6-F.7	G.6-G.7	O.12-O.13	P.14-P.15	M.10-M.11
Price from	587,-	346,-*	617,-	364,-*	907,-	999,-	499,-*	549,-*	1.196,-	1.485,-	3.191,-	3.191,-	905,-*

Rectangular - Sliding door, 3-section corner entry

Page	D.4-D.5	D.6-D.7	D.20-D.21	D.22-D.23	E.6-E.7		E.8-E.9						
Price from	677,-	391,-*	710,-	410,-*	1.120,-		616,-*						

Quadrant - Sliding door

Page	D.18-D.19		D.32-D.33		E.16-E.17	E.26-E.27			F.20-F.21	G.20-G.21			
Price from	677,-		710,-		1.047,-	1.152,-			1.196,-	1.621,-			

Rectangular - Sliding door, 1-panel with fixed segment and side panel

Page										O.8-O.9	P.8-P.11		
Price from										3.493,-	3.556,-		

Rectangular - Sliding door, 2-panel with fixed segments and side panel

Page										O.10-O.11	P.12-P.13		
Price from										4.133,-	4.214,-		

Rectangular - Sliding door, 2-panel with fixed segments and two side panels as U-shaped enclosure

Page										O.14-O.15	P.16-P.17		
Price from										5.161,-	5.262,-		

* Corner entry: prices listed are per side.

For side panel or for recess

	Alpha 2 fully framed	Alpha 2 partly framed	Classics 2	Classics 2 EasyEntry	Aura	Design	Xtensa
--	----------------------	-----------------------	------------	----------------------	------	--------	--------

Rectangular - Sliding door, 1-panel with fixed segment

Page	D.8-D.9	D.24-D.25	E.10-E.11	E.22-E.23	F.8-F.11	G.8-G.11	M.4-M.7
Price from	602,-	630,-	823,-	905,-	819,-	967,-	1.139,-

Rectangular - 2-panel sliding door with fixed segment

Page	D.8-D.9	D.24-D.25	E.12-E.13				
Price from	497,-	522,-	702,-				

Rectangular - Sliding door, 2-panel with fixed segments

Page					F.16-F.17	G.16-G.17	M.12-M.13
Price from					1.196,-	1.514,-	1.948,-

Rectangular - 3-panel sliding door

Page	D.10-D.11						
Price from	574,-						

Rectangular - Sliding door with fixed segment and additional section

Page					F.14-F.15	G.14-G.15	M.16-M.17
Price from					1.001,-	1.310,-	1.526,-

Rectangular - Side panel

Page	D.16-D.17	D.30-D.31	E.14-E.15	E.24-E.25	F.12-F.13	G.12-G.13	M.8-M.9
Price from	299,-	315,-	388,-	426,-	376,-	608,-	574,-

Rectangular - Side panel for sliding door 2-panel with fixed segments / Sliding door with fixed segment and additional section

Page					F.18-F.19	G.18-G.19	M.18-M.19
Price from					376,-	608,-	574,-

Rectangular - Side panel for sliding door, 2-panel with 2 fixed segments

Page							M.14-M.15
Price from							574,-

For recess

	Vista frameless	Vista partially framed	Xtensa
--	-----------------	------------------------	--------

Rectangular - Sliding door, 1-panel with fixed segment in recess

Page	O.4-O.5	P.4-P.5	M.4-M.7
Price from	2.379,-	2.427,-	1.139,-

Rectangular - Sliding door, 2-panel with fixed segments in recess

Page	O.6-O.7	P.6-P.7	
Price from	3.191,-	3.251,-	

Product range overview - Swing doors - Corner solutions

	Classics 2	Classics 2 (1/2)	Aura	Aura (1/2)	Design (1/2)	Design pure	501 Design (1/2)	Enjoy frameless	Enjoy partially framed	Solva frameless	Solva partially framed	Refresh	Paris/Berlin frameless	Paris/Berlin partially framed
--	------------	------------------	------	------------	--------------	-------------	------------------	-----------------	------------------------	-----------------	------------------------	---------	------------------------	-------------------------------

Rectangular - Swing door corner entry

Page	E.32-E.33	E.34-E.35			G.28-G.29		H.6-H.7					N.4-N.5	Q.40-Q.41	R.38-R.39
Price from	1.243,-	663,-*			737,-*		737,-*					2.158,-	2.693,-	2.693,-

Rectangular - Swing door corner entry with fixed segments

Page	E.38-E.39	E.40-E.41	F.22-F.23	F.26-F.29	G.32-G.35	G.38-G.41	H.8-H.9	I.4-I.5	J.4-J.5	K.32-K.33	L.38-L.39	N.4-N.5	Q.42-Q.43	R.40-R.41
Price from	1.303,-	698,-*	1.703,-	851,-*	737,-*	791,-	737,-*	3.234,-	2.488,-	3.624,-	1.609,-	2.158,-	3.537,-	3.537,-

Rectangular - Folding swing door corner entry

Page					G.42-G.45	H.10-H.13				K.34-K.35	L.40-L.41			
Price from					848,-*	848,-*				3.986,-	1.569,-			

Rectangular - Folding swing door corner entry with fixed segments

Page				G.46-G.49										
Price from				1.371,-*										

* Corner entry: prices listed are per side.



Product range overview - Swing doors - Corner solutions

	Classics 2 (1/2)	Aura	Design (1/2)	501 Design (1/2)	Enjoy frameless	Enjoy partially framed	Solva frameless	Solva partially framed	Refresh	Paris/Berlin frameless	Paris/Berlin partially framed
--	------------------	------	--------------	------------------	-----------------	------------------------	-----------------	------------------------	---------	------------------------	-------------------------------

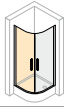
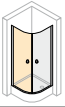

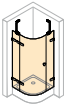
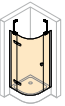
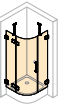
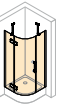
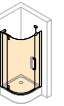
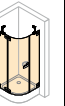

Quadrant - Swing door 2-panel (1/2)

											
Page			G.68-G.69	H.22-H.23							
Price from			760,-*	760,-*							

Quadrant - Swing door with fixed segments, 1-panel

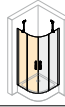
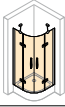
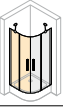
											
Page					I.18-I.19	J.30-J.33	K.38-K.39	L.44-L.45	N.16-N.17	Q.46-Q.47	R.44-R.45
Price from					3.234,-	2.488,-	3.199,-	2.854,-	2.158,-	3.115,-	3.115,-

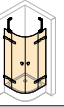
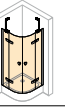
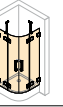
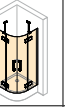
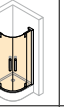
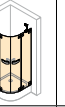
Quadrant - Swing door with fixed segments, 2-panel

											
Page	E.54-E.55	F.32-F.33	G.70-G.71	H.24-H.25	I.16-I.17	J.34-J.35	K.36-K.37	L.42-L.43	N.14-N.15	Q.44-Q.45	R.42-R.43
Price from	651,-*	1.892,-	760,-*	760,-*	3.234,-	2.488,-	3.624,-	2.854,-	2.158,-	3.537,-	3.537,-

	Aura	Design	501 Design	Enjoy frameless	Enjoy partially framed	Solva frameless	Solva partially framed	Refresh	Paris/Berlin frameless	Paris/Berlin partially framed
--	------	--------	------------	-----------------	------------------------	-----------------	------------------------	---------	------------------------	-------------------------------

Pentagonal - Swing door with fixed segments, 1-panel

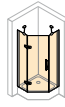
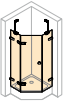
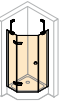
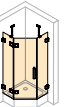
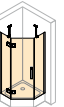
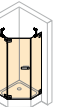
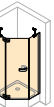
										
Page	F.34-F.35			I.20-I.21	J.36-J.37	K.42-K.43	L.48-L.49		Q.50-Q.51	R.48-R.49
Price from	1.487,-			3.234,-	2.488,-	3.199,-	2.854,-		3.115,-	3.115,-

Pentagonal - Swing door with fixed segments, 2-panel

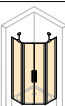
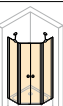
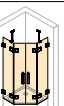
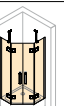
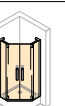
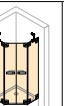
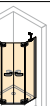
										
Page		G.72-G.73	H.26-H.27			K.40-K.41	L.46-L.47	N.18-N.19	Q.48-Q.49	R.46-R.47
Price from		1.520,-	1.520,-			3.624,-	2.854,-	2.158,-	3.537,-	3.537,-

	Refresh
--	---------

Semicircular - Swing door with fixed panels

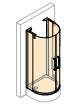
	
Page	N.20-N.21
Price from	2.574,-

* Corner entry: prices listed are per side.

Product range overview - Swing doors - With side panel

	Enjoy frameless	Solva frameless	Paris/Berlin frameless	Paris/Berlin partially framed
--	-----------------	-----------------	------------------------	-------------------------------

Rectangular - Swing door with side panel

Page	I.12-I.13	K.16-K.17	Q.22-Q.23	R.20-R.21
Price from	2.108,-	2.738,-	2.693,-	2.693,-

Rectangular - Swing door with short side panel on bathtub

Page		K.18-K.19	Q.24-Q.25	R.22-R.23
Price from		3.079,-	2.693,-	2.693,-

Rectangular - Folding swing door with side panel

Page		K.20-K.21		
Price from		3.261,-		

Rectangular - Swing door with fixed segment and side panel

Page	I.8-I.9	K.22-K.23	Q.26-Q.27	R.24-R.27
Price from	2.108,-	3.079,-	3.115,-	3.115,-

Rectangular - Swing door with fixed segment and shortened side panel on bathtub

Page		K.24-K.25	Q.28-Q.29	R.28-R.29
Price from		3.079,-	3.115,-	3.115,-

	Solva frameless	Paris/Berlin frameless	Paris/Berlin partially framed
--	-----------------	------------------------	-------------------------------

Rectangular - Swing door with additional section and side panel

Page	K.26-K.27	Q.30-Q.31	R.30-R.31
Price from	3.079,-	3.115,-	3.115,-

Rectangular - Swing door with additional section and shortened side panel on bathtub

Page		Q.32-Q.33	
Price from		3.115,-	

Rectangular - Two-way door with side panel

Page	K.30-K.31	Q.34-Q.35	R.32-R.33
Price from	3.282,-	3.115,-	3.115,-

Rectangular - Swing door with fixed segment, with additional section and side panel

Page	K.28-K.29	Q.38-Q.39	R.36-R.37
Price from	3.554,-	3.537,-	3.537,-

Rectangular - Two-way door with two side panels as U-shaped enclosure

Page		Q.36-Q.37	R.34-R.35
Price from		4.380,-	4.380,-

Product range overview - Swing doors - For side panel

	Alpha 2 fully framed	Alpha 2 partly framed	Classics 2	Aura	Design	Design*	501 Design	Enjoy partially framed	Solva partially framed	Refresh
--	----------------------	-----------------------	------------	------	--------	---------	------------	------------------------	------------------------	---------

Rectangular - Swing door

Page	D.12-D.13	D.26-D.27	E.34-E.35		G.28-G.29	G.30-G.31	H.6-H.7	J.16-J.17	L.16-L.17	N.6-N.7
Price from	496,-	521,-	663,-		737,-	737,-	737,-	1.257,-	1.440,-	1.180,-

Rectangular - Swing door with fixed segment

Page			E.40-E.41	F.26-F.29	G.32-G.35	G.36-G.37	H.8-H.9	J.8-J.11	L.20-L.23	N.8-N.9
Price from			698,-	851,-	737,-	737,-	737,-	1.257,-	1.440,-	1.180,-

Rectangular - Folding swing door

Page					G.42-G.45		H.10-H.13		L.18-L.19	
Price from					848,-		848,-		1.584,-	

Rectangular - Folding swing door with fixed segment

Page					G.46-G.49					
Price from					1.371,-					

Rectangular - Swing door with additional section for side panel

Page								L.26-L.27		
Price from								1.440,-		

Rectangular - Swing door with fixed segment, plus additional section for side panel

Page								L.28-L.31		
Price from								1.815,-		

Rectangular - Side panel

Page	D.16-D.17	D.30-D.31	E.44-E.45		G.50-G.51		H.14-H.15	J.18-J.19	L.24-L.25	N.10-N.11
Price from	299,-	315,-	442,-		517,-		517,-	851,-	984,-	654,-

Rectangular - Side panel for swing door with fixed segment

Page				F.30-F.31				J.12-J.13		
Price from				514,-				851,-		

Rectangular - Movable side panel swing door

Page					G.52-G.53					
Price from					595,-					

* Swing door opening inwards/outwards for combination with side panel

Swing door with fixed segments opening inwards/outwards for combination with side panel

Product range overview - Swing doors - In recess

	Alpha 2 fully framed	Alpha 2 partly framed	Classics 2	Aura	Design	Design*	Design pure	501 Design	Enjoy frameless	Enjoy partially framed	Solva frameless	Solva partially framed	Refresh	Paris/Berlin frameless	Paris/Berlin partially framed
--	----------------------	-----------------------	------------	------	--------	---------	-------------	------------	-----------------	------------------------	-----------------	------------------------	---------	------------------------	-------------------------------

Rectangular - Swing door in recess

Page	D.12-D.13	D.26-D.27	E.36-E.37		G.28-G.29	G.30-G.31		H.6-H.7	I.10-I.11	J.14-J.15	K.4-K.5	L.4-L.5	N.6-N.7	Q.12-Q.13	R.10-R.11
Price from	496,-	521,-	722,-		737,-	737,-		737,-	1.634,-	1.257,-	1.829,-	1.440,-	1.180,-	1.762,-	1.762,-

Rectangular - Swing door with fixed segment in recess

Page			E.42-E.43	F.24-F.25	G.32-G.35	G.36-G.37	G.38-G.41	H.8-H.9	I.6-I.7	J.6-J.7	K.8-K.9	L.8-L.9	N.8-N.9	Q.16-Q.17	R.14-R.15
Price from			756,-	945,-	737,-	737,-	791,-	737,-	1.634,-	1.257,-	1.829,-	1.440,-	1.180,-	2.311,-	2.311,-

Rectangular - Folding swing door

Page					G.42-G.45			H.10-H.13			K.6-K.7	L.6-L.7			
Price from					848,-			848,-			2.011,-	1.584,-			

Rectangular - Folding swing door with fixed segment

Page					G.46-G.49										
Price from					1.371,-										

Rectangular - Swing door with fixed segment and additional section in recess

Page					G.58-G.59						K.12-K.13	L.12-L.13		Q.20-Q.21	R.18-R.19
Price from					1.318,-						2.304,-	1.815,-		3.115,-	3.115,-

Rectangular - Swing door with additional section in recess

Page			E.46-E.47	G.56-G.57					I.14-I.15	J.20-J.21	K.10-K.11	L.10-L.11		Q.18-Q.19	R.16-R.17
Price from			998,-	1.056,-					1.634,-	1.257,-	1.829,-	1.440,-		2.311,-	2.311,-

Rectangular - Two folding swing doors in recess

Page					G.54-G.55										
Price from					1.485,-										

* Swing door opening inwards/outwards for combination with side panel
 Swing door with fixed segments opening inwards/outwards for combination with side panel

Product range overview - Two-way doors - For side panel or for recess

	Alpha 2 fully framed	Alpha 2 partly framed	Classics 2	Design	501 Design	Enjoy partially framed	Solva frameless	Solva partially framed	Refresh	Paris/Berlin frameless	Paris/Berlin partially framed
--	----------------------	-----------------------	------------	--------	------------	------------------------	-----------------	------------------------	---------	------------------------	-------------------------------

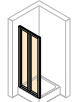
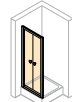
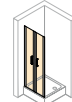
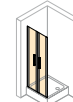
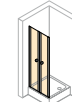
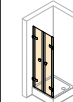
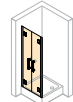

Rectangular - Two-way door for side panel

											
Page	D.14-D.15	D.28-D.29	E.48-E.49	G.64-G.65	H.18-H.19	J.24-J.25		L.32-L.33			
Price from	513,-	538,-	756,-	848,-	848,-	1.656,-		1.847,-			

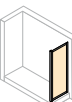
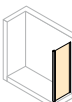
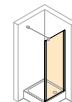
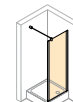
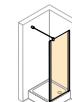
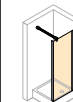
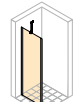
Rectangular - Side panel

											
Page	D.16-D.17	D.30-D.31	E.50-E.51	G.66-G.67	H.20-H.21	J.26-J.29		L.34-L.37			
Price from	299,-	315,-	442,-	517,-	517,-	851,-		984,-			

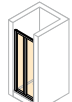
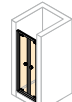
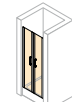
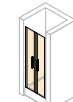
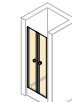
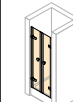
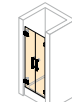
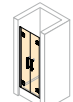
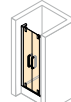
Rectangular - Two-way door in recess

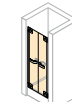
											
Page	D.14-D.15	D.28-D.29	E.48-E.49	G.60-G.61	H.16-H.17	J.22-J.23	K.14-K.15	L.14-L.15	N.12-N.13	Q.14-Q.15	R.12-R.13
Price from	513,-	538,-	756,-	848,-	848,-	1.656,-	2.344,-	1.847,-	1.545,-	2.311,-	2.311,-

Rectangular - Two-way with additional section in recess

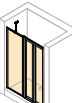
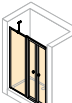
											
Page	D.14-D.15	D.28-D.29									
Price from	759,-	796,-									

Product range overview - Walk-In

	Design	501 Design	Enjoy frameless	Enjoy partially framed	Solva frameless	Solva partially framed	Paris/Berlin frameless	Paris/Berlin partially framed	Duplo	Xtensa	ConnectPro
--	--------	------------	-----------------	------------------------	-----------------	------------------------	------------------------	-------------------------------	-------	--------	------------

Rectangular - Walk-In

Page									S.22-S.23	M.4-M.7	
Price from									2.041,-	1.139,-	

Rectangular - Walk-In model 1

Page							S.34-S.35	S.48-S.49			
Price from							2.428,-	2.428,-			

Rectangular - Walk-In model 2

Page							S.36-S.37	S.50-S.51			
Price from							2.428,-	2.428,-			

Rectangular - Walk-In model 3

Page							S.38-S.39	S.52-S.53			
Price from							2.428,-	2.428,-			

Rectangular - Walk-In model 4 / Walk-In side panel with movable segment

Page	S.4-S.5	S.6-S.7	S.10-S.11	S.14-S.15	S.26-S.27	S.28-S.29	S.40-S.41	S.54-S.55			S.18-S.19
Price from	977,-	1.015,-	1.634,-	1.257,-	1.595,-	1.440,-	1.159,-	1.159,-			404,-

Rectangular - Free standing side panel

Page	S.2-S.3		S.8-S.9	S.12-S.13	S.24-S.25		S.30-S.31	S.42-S.45			
Price from	519,-		1.107,-	1.107,-	932,-		836,-	836,-			

Rectangular - Free-standing side panel

Page							S.32-S.33	S.46-S.47			
Price from							836,-	836,-			

Rectangular - Optional segment for Walk-In, fixed

Page											S.16-S.17
Price from											214,-

Rectangular - Optional door for Walk-In, movable

Page											S.20-S.21
Price from											1.114,-

Product range overview - Bath-top shower screens

	Design	501 Design	Combinett 2	Solva frameless	Solva partially framed	Paris/Berlin frameless	Paris/Berlin partially framed	Xtensa
--	--------	------------	-------------	-----------------	------------------------	------------------------	-------------------------------	--------

Bathtub - 1-panel

Page	T.4-T.5	T.14-T.15		T.28-T.29	T.34-T.35	T.40-T.41	T.44-T.45	
Price from	366,-	366,-		914,-	721,-	874,-	874,-	

Bathtub - 1-panel with fixed segment / 2-panel

Page	T.6-T.7	T.16-T.17	T.22-T.23	T.30-T.31	T.36-T.37	T.42-T.43	T.46-T.47	
Price from	541,-	541,-	362,-	1.372,-	1.080,-	1.452,-	1.452,-	

Bathtub - 3-panel

Page	T.10-T.11		T.22-T.23					
Price from	822,-		415,-					

Bathtub - 3-panel with larger 1st panel

Page			T.24-T.25					
Price from			453,-					

Bathtub - Sliding door, 1-panel with fixed segment

Page							T.2-T.3	
Price from							1.062,-	

Bathtub - Folding swing door

Page	T.8-T.9	T.18-T.19		T.32-T.33	T.38-T.39			
Price from	737,-	737,-		1.511,-	1.189,-			

Bathtub - Side panel

Page	T.12-T.13	T.20-T.21	T.26-T.27					
Price from	423,-	423,-	375,-					

Profile colours

Profile colours/ Cover profile

	Colour code	HÜPPE Alpha 2	HÜPPE Classics 2	HÜPPE Aura elegance	HÜPPE Design elegance/pure sliding doors	HÜPPE Design elegance/pure swing doors	HÜPPE 501 Design pure	HÜPPE Enjoy elegance/pure frameless	HÜPPE Enjoy elegance/pure partially framed	HÜPPE Solva pure frameless	HÜPPE Solva pure partially framed	HÜPPE Xiensa pure	HÜPPE Refresh pure	HÜPPE Vista pure	HÜPPE ConnectPro	HÜPPE Duplo pure	HÜPPE Xiensa pure bath-top shower screen	HÜPPE Design elegance/pure bath-top shower screen	HÜPPE 501 Design pure bath-top shower screen	HÜPPE Combinett 2 bath-top shower screen	HÜPPE Solva pure frameless bath-top shower screen	HÜPPE Solva pure partially framed bath-top shower screen	
Black	023				• ^{3,4}	• ^{3,4}																	
White	055	•	•	•	• ^{3,4}	• ^{3,4}			•				•					•	•	•			
Grey/brown	061				• ^{3,4}	• ^{3,4}												•	•				
Silver high-gloss	069		•		• ⁶							•					•						
Titanium silver	084												•										
Matt silver	087	•	•	•	• ^{3,4,5}	•		•					•					•	•	•			
Silver high-gloss	092			•	• ^{3,4}	•	•	•	•	•	•		•		•			•	•	•	•	•	•
Black Edition	123				• ^{1,5}							•					•	• ¹					
Metallic Edition	138				• ^{1,7}																		
Chrome/chrome	C91													•		•							
High-gloss silver/matt silver	H87																						
High-gloss silver/black	H23				• ²																		
High-gloss silver/white	H55				• ²																		
High-gloss silver/grey-brown	H61				• ²																		

¹ only HÜPPE Design pure

² not with side panel for sliding door 1-panel with fixed segment and side panel for sliding door 2-panel with fixed segments

³ Model swing door with fixed segments, 2-panel, Pentagonal not available in design style pure

⁴ Model swing door with fixed segment and additional section in recess, Rectangular, not available in elegance design

⁵ available for swing door with fixed segment and fitting

⁶ only available for swing door with fixed segment and fitting

⁷ only available for free-standing side panel model

	Colour code	Basic colour	Colour code Basic colour	Fittings/Profile colour	Profile colour	HÜPPE Studio Paris elegance/Berlin pure frameless	HÜPPE Studio Paris elegance/Berlin pure partially framed
Chrome	C					•	•
High-grade matt chrome	F					•	•
Brilliant gold	G					•	•
Chrome		C					•
High-gloss silver							•
High-grade matt chrome		F					•
High-grade matt chrome							•
Brilliant gold		G					•
pearl gold							•
Brilliant gold			02			•	•
High-grade matt chrome			05			•	•
Black			23			•	•
White			55			•	•
Chrome			91			•	•
Black Edition			123			•	•

Matt silver



White



High-gloss silver

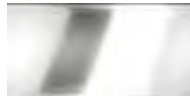

Brushed silver



Titanium silver



Chrome/chrome



Black

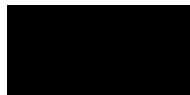

Grey/brown

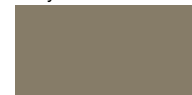

Black Edition



Metallic Edition



Panel options

	without Anti-Plaque	with Anti-Plaque	HÜPPE Alpha 2 fully framed	HÜPPE Alpha 2 partly framed	HÜPPE Classics 2	HÜPPE Aura elegance	HÜPPE Design elegance/pure sliding doors	HÜPPE Design elegance/pure swing doors	HÜPPE 501 Design pure	HÜPPE Enjoy elegance/pure frameless	HÜPPE Enjoy elegance/pure partially framed	HÜPPE Solva pure frameless	HÜPPE Solva pure partially framed	HÜPPE Xtensa pure	HÜPPE Refresh pure	HÜPPE Vista pure	HÜPPE ConnectPro	HÜPPE Duplo pure	HÜPPE Xtensa pure bath-top shower screen	HÜPPE Design elegance/pure bath-top shower screen	HÜPPE 501 Design pure bath-top shower screen	HÜPPE Combinett 2 bath-top shower screen	HÜPPE Solva pure frameless bath-top shower screen	HÜPPE Solva pure partially framed bath-top shower screen	
Styrene Pacific S clear	264		• ¹																						
Grey	301	368					• ²	• ²	• ²			• ^{2,3}	• ^{2,3}	•								•			
Clear	321	322	•	•	•	•	•	• ⁶	•	•	•	•	•	•	•	•	•	•	•	•	•	•	•	•	•
Karo	311	312																							
Bronze	341	378					• ²	• ²	• ²			• ^{2,3}	• ^{2,3}	•											
Privatima	373	375	•	•	•	•	•	• ⁶	•	•	•	•	•												
Bubbles	376	377					•	•	•	•	•	•	•												
Sand Plus	315	316				•	•	•	•	•	•	• ²	• ²	•	•	•	•	•	•	•	•	•	•	•	•
Mirror glass	380	381				• ²	• ^{2,3}			• ^{2,3}	• ^{2,3}	• ^{2,3}	• ^{2,3}	•		•	•	•	•	•					
Combi-decor Sandplus	317	318																•							
Decor Element glass	372	389						• ⁴						• ⁵											

¹ not with swing door

² not available for quadrant models

³ not available for pentagonal models

⁴ Free standing side panel

⁵ Sliding door, 1-panel with fixed segment

⁶ available for swing door with fixed segment and fitting

Mirror glass

- Safety glass with chromium-containing multi-layer system.
- Corrosion-resistant and impervious to water vapour.
- The glass is not completely opaque - depending on the lighting for the shower area. It cannot be looked through from the brighter to the darker area.
- Mirror glass is not available with sand-blasted decors or other decors.
- The glass is not intended for use with LEDs in the panel edge.

Individual transparent spots and irregularities in the mirror glass are unavoidable for production-related reasons and do not represent grounds for complaint.

! When ordering, state which segment should be fitted with mirror glass. If this is not stated, the entire unit will be fitted with mirror glass.

Clear



Bubbles



Bronze



Karo



Combi-decor Sandplus



Grey



Sand Plus

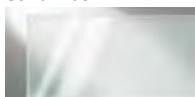

Pacific S clear

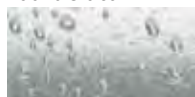

Green



Privatima



Optiwhite

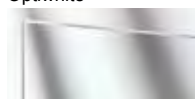

Mastercarre



Decor Element glass



Mirror glass

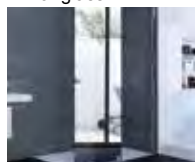

	without Anti-Plaque	with Anti-Plaque	Sand-blasted decors	HÜPPE Studio Paris elegance/Berlin pure frameless	HÜPPE Studio Paris elegance/Berlin pure partially framed
Clear	321	322		•	•
Karo	311	312		•	•
Sand Plus	315	316		•	•
Privatima	373	375		•	•
Mirror glass ^{1,2}	380	381		•	•
Grey ¹		368		•	•
Bronze ¹		378		•	•
Green ¹		358		•	•
Optiwhite ¹		310		•	•
Mastercarre ¹		325		•	•
Chinchilla ¹		393		•	•
Orient ¹			305	•	•
Liquid ¹			303	•	•
Sign ¹			363	•	•
Floral ¹			302	•	•
Nature ¹			366	•	•
Loop ¹			306	•	•
Roses ¹			362	•	•
Royal ¹			365	•	•
Leaves ¹			304	•	•

¹ not available for quadrant models

² not available for pentagonal models

Accessory kit - Handles

Handles

Fancy other handles?

- HÜPPE products allow you to choose different handles for a particular purpose.
- If, for instance, you prefer the handle of a different series, it can be ordered as an option to replace the standard one.
- The table below lists which handle is compatible with which series.

			HÜPPE Alpha 2	HÜPPE Design pure swing doors	HÜPPE 501 Design pure	HÜPPE Enjoy elegance	HÜPPE Enjoy pure	Product no.	Price
Knob handle	HÜPPE Alpha 2		○	●*	●	●	●	070075	66,-
Knob handle	HÜPPE 501 Design pure		●	●*	○	●	●	070077	
Knob handle	HÜPPE Enjoy elegance		●	●*	●	○	●	070083	
Knob handle	HÜPPE Enjoy pure		●	●*	●	●	○	070081	
Knob handle	HÜPPE Design pure		●	●**	●	●	●	070088	
Comfort handle	HÜPPE Design pure		●	○	●	●	●	070076	

○ as standard

* cannot be used for U-shaped solutions with folding swing door and folding swing door with fixed segment.

** Especially for folding swing doors, to improve impact absorption.

Handles

			HÜPPE Classics 2	HÜPPE Aura elegance	HÜPPE Design elegance	HÜPPE Design pure sliding doors	HÜPPE Solva pure	Product no.	Price
Bow-shaped handle	HÜPPE Classics 2		○	●	●*	●	●	070082	165,-
Bow-shaped handle	HÜPPE Aura elegance		●	○	●*	●	●	070078	
Bow-shaped handle	HÜPPE Design elegance		●	●	○	●	●	070079	
Bow-shaped handle	HÜPPE Design pure		●	●	●*	○	●	070085	
Bow-shaped handle	HÜPPE Solva pure		●	●	●*	●	○	070084	

○ as standard

* cannot be used for U-shaped solutions with folding swing door and folding swing door with fixed segment.

** Especially for folding swing doors, to improve impact absorption.

HÜPPE shower trays



HÜPPE Xerano

Rectangular

Shower tray with integrated front panel 120mm

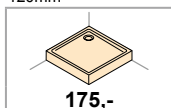

A.4-A.5

Shower tray without front panel 60mm

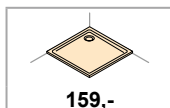

A.4-A.5

Quadrant

Shower tray with integrated front panel 120mm

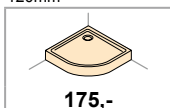

A.6-A.7

Shower tray without front panel 60mm

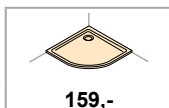

A.6-A.7

HÜPPE Purano

Rectangular

Shower tray

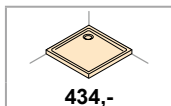

A.10-A.11

Quadrant

Shower tray

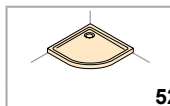

A.12

Pentagonal

Shower tray

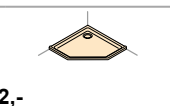

A.13

Semicircular

Shower tray



A.14-A.15

HÜPPE EasyStep

Rectangular

Shower tray

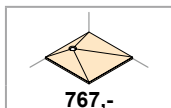

A.18-A.21

HÜPPE EasyFlat

Rectangular

Shower tray

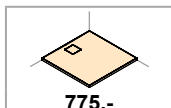

A.24-A.27

NEW

Purano shower trays: Additional tray sizes now also available!
EasyStep shower trays: Additional tray sizes now also available!

HÜPPE Xerano



Product details



The simple, timeless design of this shower tray of bathroom-grade acrylic blends in perfectly with a wide range of bathroom designs



The discreetly - only 25-30mm - deeper shower area of the HÜPPE Purano shower trays is part of the timeless HÜPPE Xerano design



The front panel and use of tray feet - if required - allow fast and easy installation

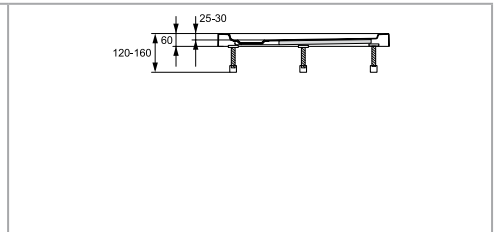
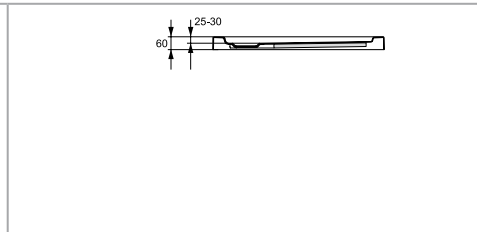
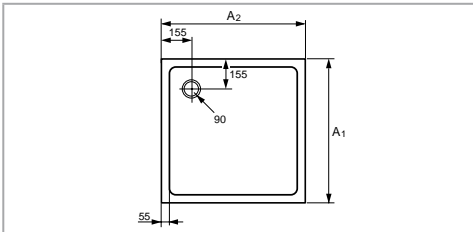

floor-flush

with feet

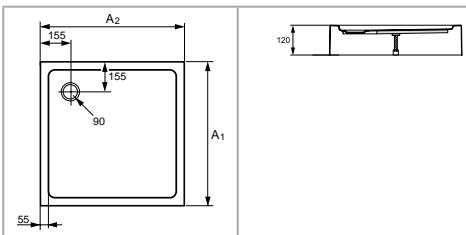

with front panel
(120mm)

Shower tray without front panel 60mm/Shower tray with integrated front panel 120mm:

- Outlet diameter complies with EURO standard for flat trays (Ø 90mm).
- Tray dimensions comply with standard tolerances.
- The use of plastic mats may cause bubbles on the tray surface.

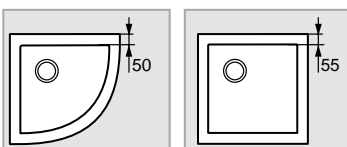

Shower tray with integrated front panel 120mm

	Tray size A2/A1	Approx. weight in kg	Product no.	Base price
	800x800	11	840701	175,-
	900x900	13	840702	

Extras

		Colour of outlet cover	Colour of outlet cover	Construction height	Product no.	Price
	Waste outlet kit 70mm construction height and cover cap, drains at up to 0.6 l/sec. Seal water level 50mm	round	White	104	215480R55	57,-
	Waste outlet kit 70mm construction height and cover cap, drains at up to 0.6 l/sec. Seal water level 50mm	round	Chrome	104	215480R91	
	Waste outlet kit 70mm construction height and cover cap, drains at up to 0.6 l/sec. Seal water level 50mm	round	24 carat gold	104	215480R89	179,-
	Flexible outlet pipe, connection diameter 50mm, lengths from 400mm to 1000mm				215482000	85,-

Wall sealing systems - see HÜPPE EasyStyle Wall Covering section.

Shower tray without front panel 60mm

	Tray size A2/A1	Approx. weight in kg	Product no.	Base price
	800 x 800	10	840301	159,-
	900 x 900	12	840302	

Extras

		Shape of outlet cover	Colour of outlet cover	Construction height	Product no.	Price
	Waste outlet kit 70mm construction height and cover cap, drains at up to 0.6 l/sec. Seal water level 50mm	round	White	104	215480R55	57,-
	Waste outlet kit 70mm construction height and cover cap, drains at up to 0.6 l/sec. Seal water level 50mm	round	Chrome	104	215480R91	
	Waste outlet kit 70mm construction height and cover cap, drains at up to 0.6 l/sec. Seal water level 50mm	round	24 carat gold	104	215480R89	179,-
	Tray feet				840501	57,-
	Flexible outlet pipe, connection diameter 50mm, lengths from 400mm to 1000mm				215482000	85,-

Wall sealing systems - see HÜPPE EasyStyle Wall Covering section.

Colours - Panel options

Profile colours	Colour code	Extra charges
White	055	0,-

HÜPPE Xerano Quadrant

Shower tray with integrated front panel 120mm

Tray size A2/A1	Approx. weight in kg	Product no.	Base price
800x800	11	840801	175,-
900x900	13	840802	



with front panel (120mm)

Extras

	Colour of outlet cover	Colour of outlet cover	Construction height	Product no.	Price
Waste outlet kit 70mm construction height and cover cap, drains at up to 0.6 l/sec. Seal water level 50mm	round	White	104	215480R55	57,-
Waste outlet kit 70mm construction height and cover cap, drains at up to 0.6 l/sec. Seal water level 50mm	round	Chrome	104	215480R91	
Waste outlet kit 70mm construction height and cover cap, drains at up to 0.6 l/sec. Seal water level 50mm	round	24 carat gold	104	215480R89	179,-
Flexible outlet pipe, connection diameter 50mm, lengths from 400mm to 1000mm				215482000	85,-

Wall sealing systems - see HÜPPE EasyStyle Wall Covering section.

Shower tray without front panel 60mm

Tray size A2/A1	Approx. weight in kg	Product no.	Base price
800 x 800	10	840402	159,-
900 x 900	12	840401	

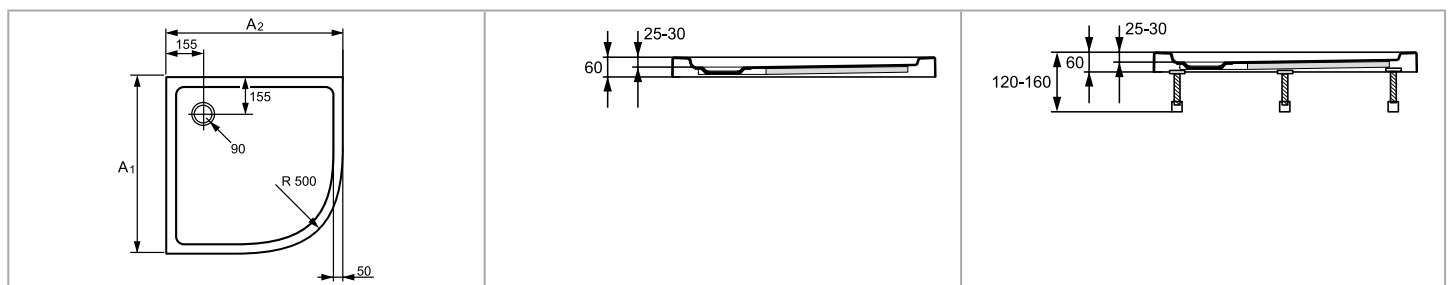

floor-flush

with feet

Extras

	Shape of outlet cover	Colour of outlet cover	Construction height	Product no.	Price
Waste outlet kit 70mm construction height and cover cap, drains at up to 0.6 l/sec. Seal water level 50mm	round	White	104	215480R55	57,-
Waste outlet kit 70mm construction height and cover cap, drains at up to 0.6 l/sec. Seal water level 50mm	round	Chrome	104	215480R91	
Waste outlet kit 70mm construction height and cover cap, drains at up to 0.6 l/sec. Seal water level 50mm	round	24 carat gold	104	215480R89	179,-
Tray feet				840501	57,-
Flexible outlet pipe, connection diameter 50mm, lengths from 400mm to 1000mm				215482000	85,-

Wall sealing systems - see HÜPPE EasyStyle Wall Covering section.

Colours - Panel options

Profile colours	Colour code	Extra charges
White	055	0,-

HÜPPE Purano



Product details



The discreetly deeper shower area - only 26mm at the deepest point - of the HÜPPE Purano shower trays is part of the minimalist pure design

Optional extras: Sturdy aluminium panel, same colour as shower tray.



Slip resistant finish integrated as standard

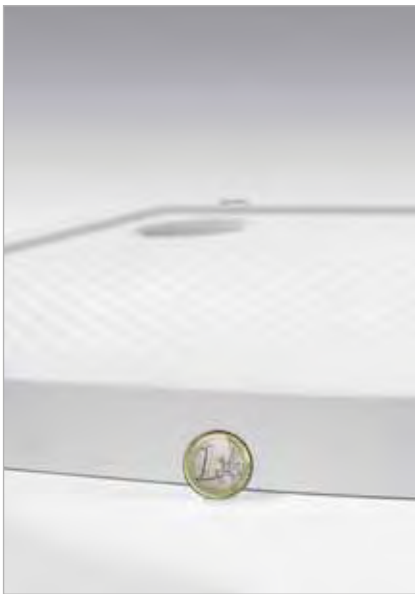

The flat shower tray is suitable for many different installation options



The gelcoat surface - also used in sailing yacht construction - is exceptionally durable:

- impact and wear-resistant
- colour-fast
- easy to clean



The materials of the HÜPPE trays - natural substances such as quartz sand and powdered minerals - have heat-retaining properties which make them extremely kind-to-the-skin and pleasant to step into

HÜPPE Purano

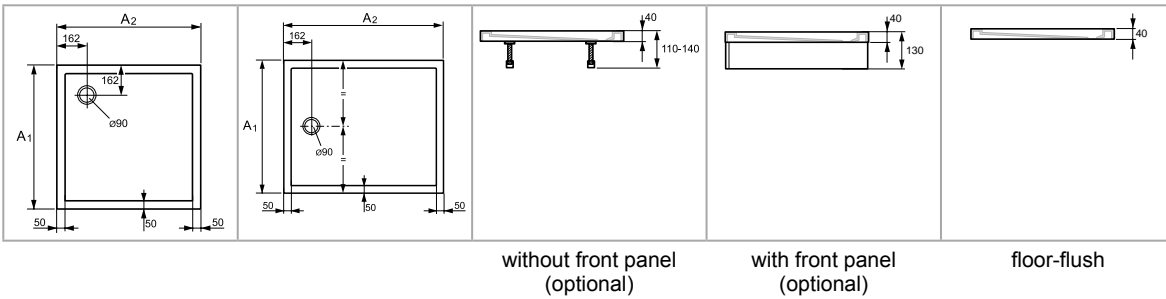
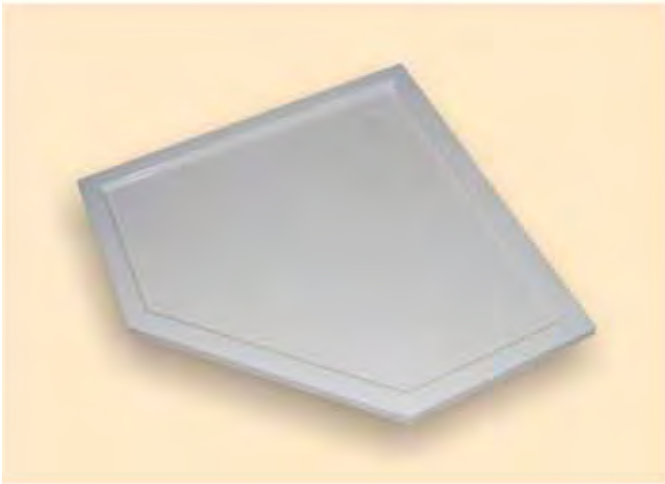
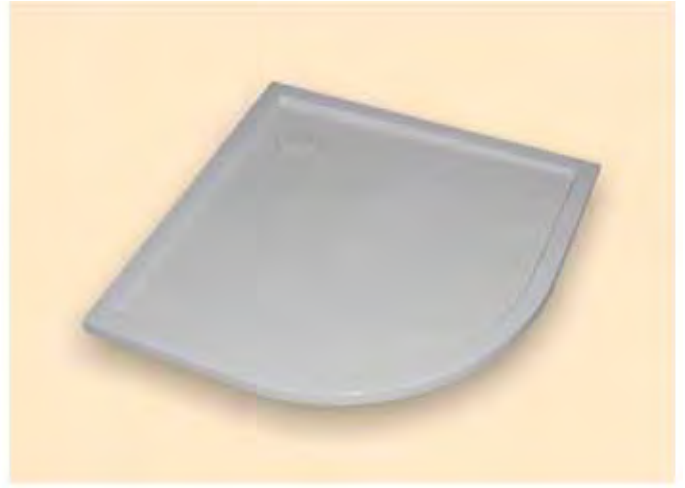
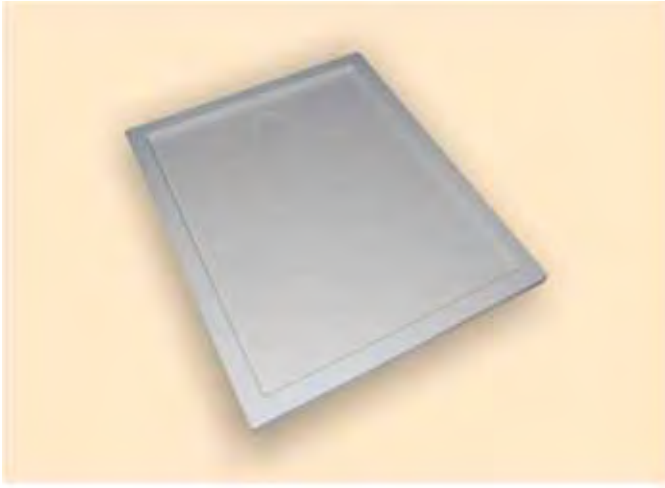

Shower tray:

- Tray dimensions comply with standard tolerances.
- Outlet diameter complies with EURO standard for flat trays ($\varnothing 90$ mm).
- The use of plastic mats may cause bubbles on the tray surface.

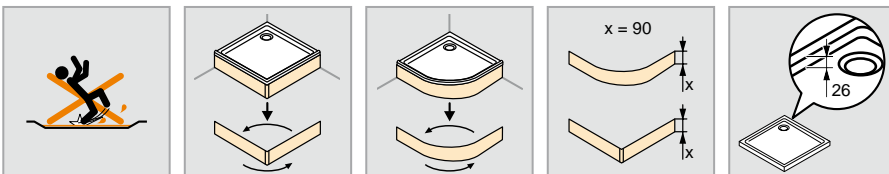

Shower tray

	Tray size A2/A1	Approx. weight in kg	Product no.	Base price
	800 x 800	30	202160	434,-
	900 x 900	40	202161	
	1000 x 1000	50	202162	
	900 x 700	30	202164	
	900 x 750	32	202168	
	900 x 800	35	202270	
	1000 x 700	34	202165	
	1000 x 800	39	202271	
	1000 x 900	44	202272	
	1200 x 700	42	202166	
	1200 x 800	48	202163	477,-
	1200 x 900	55	202158	
	1200 x 1000	62	202273	
	1400 x 700	51	202167	
	1400 x 900	67	202159	

Extras

		Shape of outlet cover	Colour of outlet cover	Construction height	Product no.	Price
	Low-profile waste outlet kit and cover cap, drains at up to 0.6 l/sec.	round	Chrome	82	508055R91	57,-
	Low-profile waste outlet kit and cover cap, drains at up to 0.6 l/sec.	round	White	82	508055R55	
	Low-profile waste outlet kit and cover cap, drains at up to 0.6 l/sec.	round	24 carat gold	82	508055R89	179,-
	Tray feet < 1200mm: 6 feet				508059000	74,-
	Tray feet ≥ 1200mm: 7 feet				508063000	
	Flexible outlet pipe, connection diameter 50mm, lengths from 400mm to 1000mm				215482000	85,-

Wall sealing systems - see HÜPPE EasyStyle Wall Covering section.

Standard equipment

Slip resistant surface

Front panel for shower tray

	Model A2/A1	Recess dimensions A2	Front panel for corner Product no.	Base price	Front panel for recess A2 Product no.	Base price
	800 x 800		202180	173,-		
	900 x 900		202181			
	1000 x 1000		202182			
	900 x 800		212007			
	900 x 700		212001			
	900 x 750		212000			
	1000 x 700		212002			
	1000 x 800		212008			
	1000 x 900		212009			
	1200 x 700		212003			
	1200 x 800		202183			
	1200 x 900		212005			
	1200 x 1000		212010			
	1400 x 700		212004			
	1400 x 900		212006			
		800				
		900			202186	
		1000			202187	
		1200			202188	
		1400			202189	

Tray colours

Profile colours	Colour code	Extra charges
White	055	0,-

Shower tray

Tray size A2/A1	Approx. weight in kg	Product no.	Base price
800 x 800	27	202150	522,-
900 x 900	36	202151	
800 x 1000	36	202148	
1000 x 800	36	202149	
900 x 800	32	202156	
800 x 900	32	202155	
1000 x 1000	47	202152	
900 x 1000	41	202153	
1000 x 900	41	202154	573,-
900 x 1200	52	202146	
1200 x 900	52	202147	

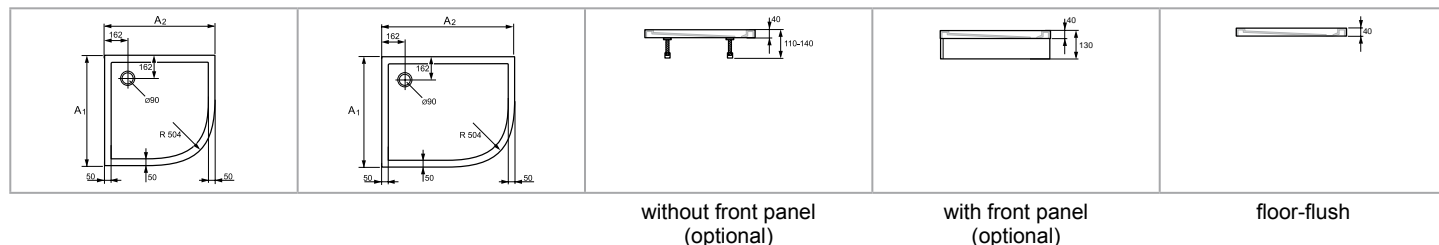

without front panel
(optional)

with front panel
(optional)

floor-flush

Extras

	Shape of outlet cover	Colour of outlet cover	Construction height	Product no.	Price
Low-profile waste outlet kit and cover cap, drains at up to 0.6 l/sec.	round	Chrome	82	508055R91	57,-
Low-profile waste outlet kit and cover cap, drains at up to 0.6 l/sec.	round	White	82	508055R55	
Low-profile waste outlet kit and cover cap, drains at up to 0.6 l/sec.	round	24 carat gold	82	508055R89	179,-
Flexible outlet pipe, connection diameter 50mm, lengths from 400mm to 1000mm				215482000	85,-
Tray feet < 1200mm: 6 feet				508059000	74,-
Tray feet ≥ 1200mm: 7 feet				508063000	

Wall sealing systems - see HÜPPE EasyStyle Wall Covering section.

Standard equipment

Slip resistant surface

Front panel for shower tray

Model A2/A1	Product no.	Base price
800 x 800	202170	173,-
900 x 900	202171	
1000 x 1000	202172	
900 x 800	202175	
1000 x 800	202178	
1000 x 900	202173	
1200 x 900	202177	

Tray colours

Profile colours	Colour code	Extra charges
White	055	0,-

Shower tray

Tray size A2/A1	Approx. weight in kg	B	C	Product no.	Base price
900 x 900	34	450	636	210601	522,-
1000 x 1000	43	500	707	210602	

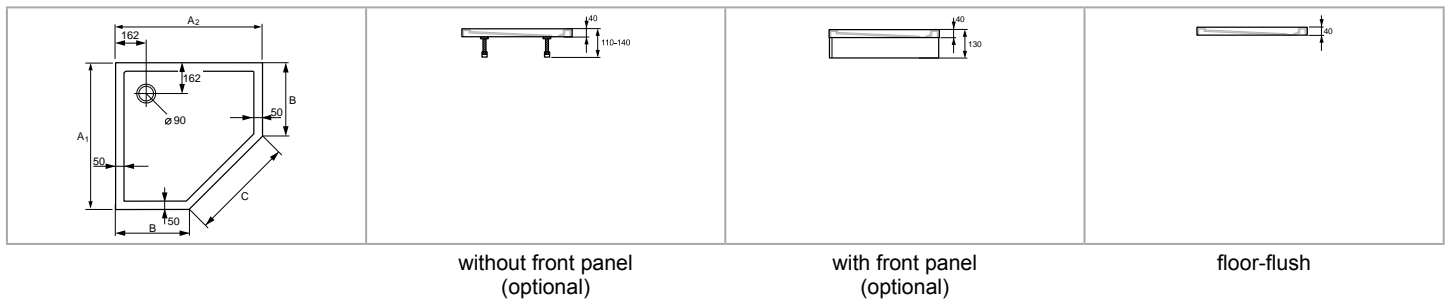

Extras

	Shape of outlet cover	Colour of outlet cover	Construction height	Product no.	Price
Low-profile waste outlet kit and cover cap, drains at up to 0.6 l/sec.	round	Chrome	82	508055R91	57,-
Low-profile waste outlet kit and cover cap, drains at up to 0.6 l/sec.	round	White	82	508055R55	
Low-profile waste outlet kit and cover cap, drains at up to 0.6 l/sec.	round	24 carat gold	82	508055R89	
Flexible outlet pipe, connection diameter 50mm, lengths from 400mm to 1000mm				215482000	85,-
Tray feet < 1200mm: 6 feet				508059000	74,-
Tray feet ≥ 1200mm: 7 feet				508063000	

Wall sealing systems - see HÜPPE EasyStyle Wall Covering section.

Standard equipment

Slip resistant surface

Front panel for shower tray





Model A2/A1	Product no.	Base price
900 x 900	210801	173,-
1000 x 1000	210802	

Tray colours

Profile colours	Colour code	Extra charges
White	055	0,-

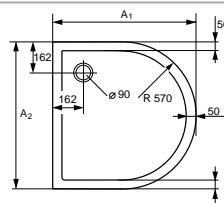
HÜPPE Purano Semicircular

Shower tray

	Tray size A2/A1 1140 x 900	Approx. weight in kg 44	Product no. 210701	Base price 812,-
				
	without front panel (optional)	with front panel (optional)	floor-flush	

Extras

	Shape of outlet cover	Colour of outlet cover	Construction height	Product no.	Price
Low-profile waste outlet kit and cover cap, drains at up to 0.6 l/sec.	round	Chrome	82	508055R91	57,-
Low-profile waste outlet kit and cover cap, drains at up to 0.6 l/sec.	round	White	82	508055R55	
Low-profile waste outlet kit and cover cap, drains at up to 0.6 l/sec.	round	24 carat gold	82	508055R89	179,-
Flexible outlet pipe, connection diameter 50mm, lengths from 400mm to 1000mm				215482000	85,-
Tray feet < 1200mm: 6 feet				508059000	74,-
Tray feet ≥ 1200mm: 7 feet				508063000	

Wall sealing systems - see HÜPPE EasyStyle Wall Covering section.

Standard equipment

Slip resistant surface

Front panel for shower tray

	Model A2/A1 1140 x 900	Product no. 210901	Base price 173,-

Tray colours

Profile colours	Colour code	Extra charges
White	055	0,-

HÜPPE EasyStep

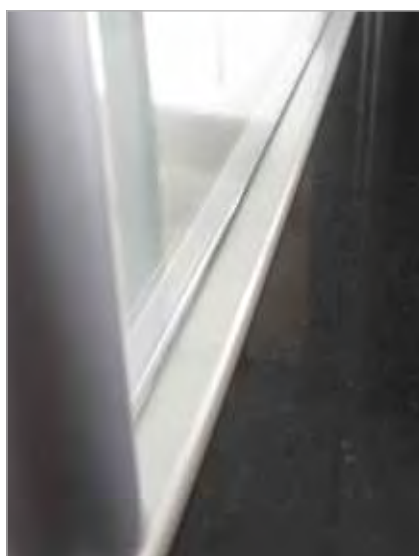

The shape of HÜPPE EasyStep allows tiles to be applied directly against the tray edge

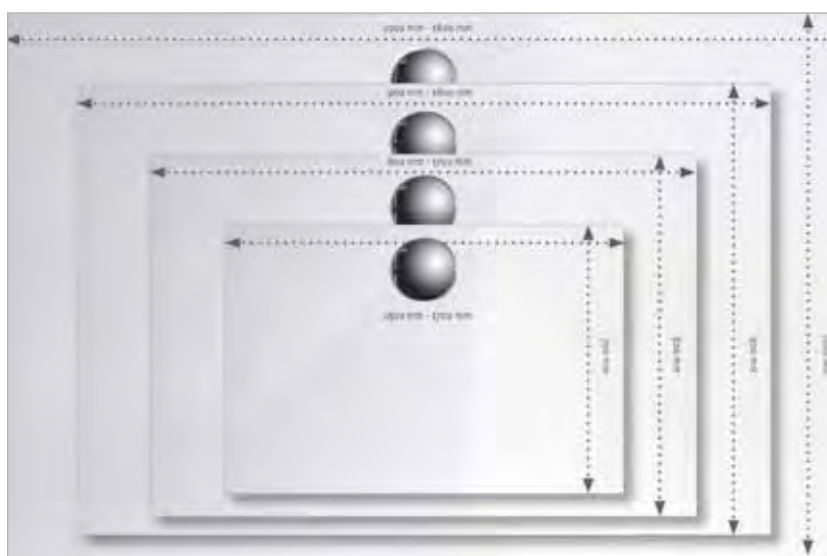

The made-to-measure option makes it possible to implement a great variety of installation situations with HÜPPE EasyStep

Product details



With only 30mm tray height, HÜPPE EasyStep is particularly suitable for floor-flush, barrier-free installation



The gelcoat surface - also used in sailing yacht construction - is exceptionally durable:

- impact and wear-resistant
- colour-fast
- easy to clean



The materials of the HÜPPE trays - natural substances such as quartz sand and powdered minerals - have heat-retaining properties which make them extremely kind-to-the-skin and pleasant to step into

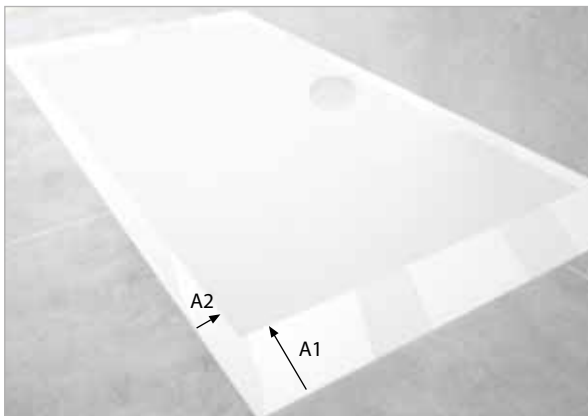

HÜPPE EasyStep with HÜPPE EasyProtect special option (anti-slip surface).

Distance tray edge to anti-slip area:

A1=140mm, A2=50mm

Anti-slip finish Analysis Group C for wet barefoot areas (**DIN 51097**).

Analysis Group R11 for anti-slip properties in working rooms and areas with a raised slipping risk level (**DIN 51130**).

The amount of residual water may increase with EasyProtect due to the surface tension.

EasyProtect is a natural product. Small, dark cavities are therefore unavoidable.

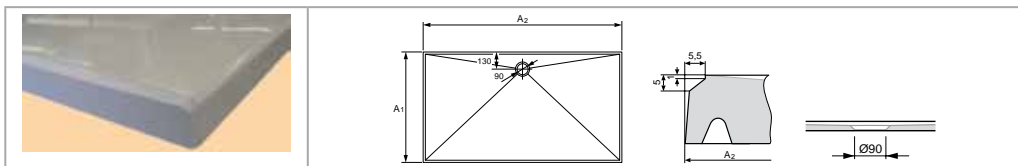

Flexible shower tray

- Tray dimensions comply with standard tolerances.
- Outlet diameter complies with EURO standard for flat trays (Ø 90mm).
- The use of plastic mats may cause bubbles on the tray surface.

Flexible and made-to-measure:

- For reasons relating to production the surface structures of the tray edges may vary slightly (see detailed photo).

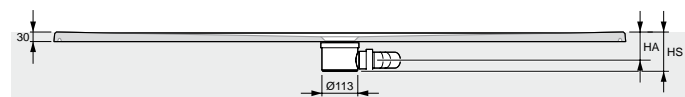

Floor-flush

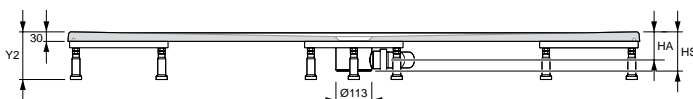

With tray pedestal

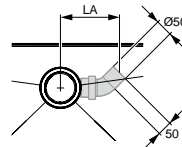

	Dimension	Siphon 53mm	Siphon 70mm	Siphon 90mm
Height of siphon connection	HA	62	70	90
Height with siphon	HS	87	104	121
Height with tray installation system	Y2	150-210 (115-150)	150-210 (115-150)	150-210 (115-150)
Space between siphon axis and the connecting pipe	LA	230	240	200



Shower tray

	Fixed	Flexible	Approx. weight in kg	Product no.	Base price
	900 x 900		37	215021	767,-
	1000 x 1000		46	215032	
	1000 x 900		40	215022	
	1200 x 900		50	215024	
	1200 x 1000		55	215034	
	1400 x 800		53	215110	893,-
	1400 x 900		59	215120	
	1400 x 1000		66	215130	
	1500 x 900		64	215121	
	1600 x 900		69	215220	
	1800 x 900		80	215222	1.058,-
		800 x 800	28	215010	767,-
		800 x 750	27	215239	
		900 x 750	31	215240	
		900 x 800	32	215011	
		1000 x 750	34	215241	
		1000 x 800	36	215012	
		1100 x 800	40	215013	
		1100 x 900	45	215023	
		1100 x 1000	50	215033	
		1200 x 750	41	215242	
		1200 x 800	44	215014	767,-
		1300 x 750	45	215243	893,-
		1300 x 800	48	215015	
		1300 x 900	54	215025	
		1300 x 1000	61	215035	
		1400 x 750	49	215244	
		1500 x 700	49	215101	
		1500 x 750	52	215245	
		1500 x 800	57	215111	
		1500 x 1000	72	215131	
		1600 x 700	53	215200	
		1600 x 750	56	215246	1.058,-
		1600 x 800	62	215210	
		1600 x 1000	77	215230	
		1700 x 700	57	215201	
		1700 x 750	59	215247	
		1700 x 800	67	215211	
		1700 x 900	75	215221	
		1700 x 1000	83	215231	
		1800 x 750	63	215248	
		1800 x 1000	89	215232	

Made-to-measure

	Tray size A2/variable	Tray size A1/fixed	Product no.	Base price
	801-999	750	215251	843,-
	1201-1399	750	215252	981,-
	1501-1799	750	215253	1.210,-
	801-1099	800	215099	843,-
	901-1099	900		
	1001-1099	1000		
	1101-1499	800	215199	981,-
	1101-1499	900		
	1101-1499	1000		
	1501-1700	700	215299	1.210,-
	1501-1700	800		
	1501-1800	900		
	1501-1800	1000		

Special options

Optional variants		Extra charges	Extra charges A2 ≥ 1500
EasyProtect	410	179,-	238,-

Tray colours

Profile colours	Colour code	Extra charges
White	055	0,-

Dimensions

Flexible pedestal

(A2/A1: see EasyStep product page)

Tray pedestal for following dimensions:

800x800, 900x900, 1000x1000

(A2/A1: see EasyStep product page)

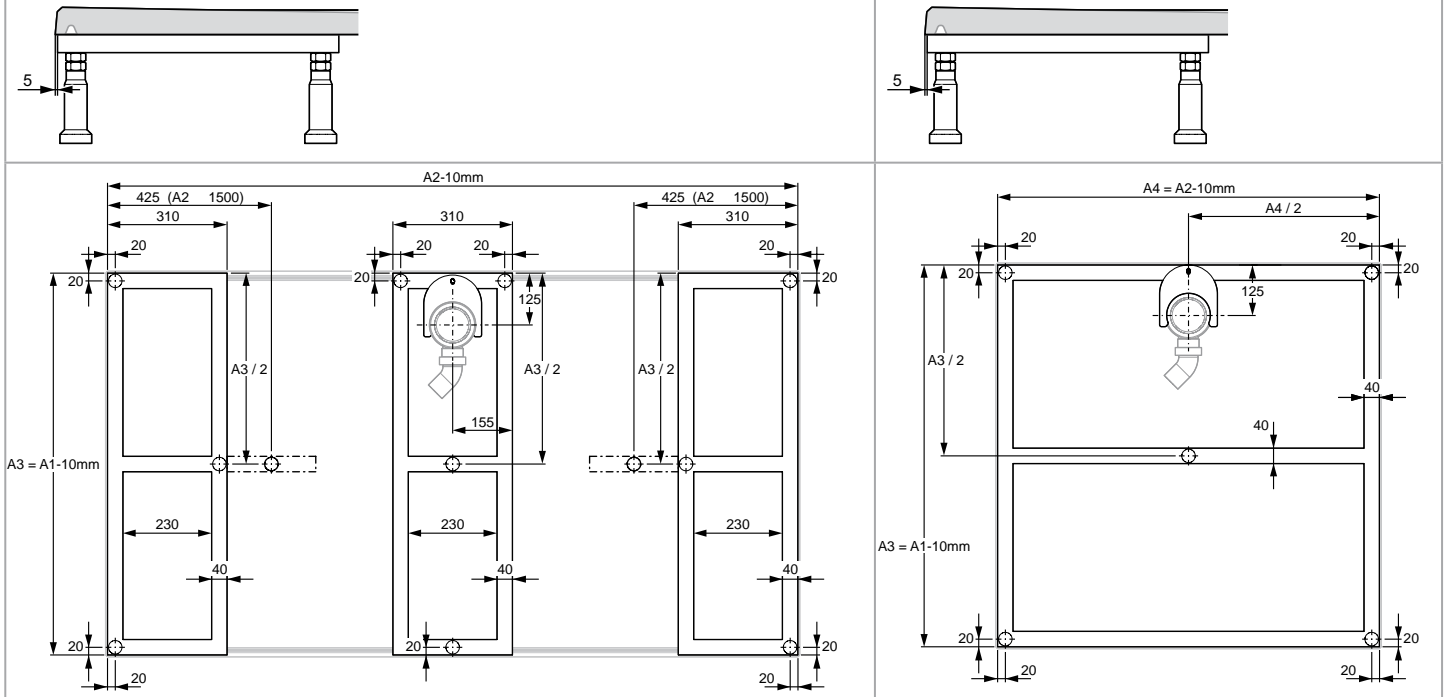

Extras

	A2	A1	Shape of outlet cover	Colour of outlet cover	Installation height incl. shower surface	Product no.	Price
Low-profile waste outlet kit. 53mm construction height and cover cap. Drains at up to 0.5 l/sec. Seal water level 40mm			round	Chrome	87	215483R91	57,-
Low-profile waste outlet kit. 53mm construction height and cover cap. Drains at up to 0.5 l/sec. Seal water level 40mm			round	White	87	215483R55	
Low-profile waste outlet kit. 53mm construction height and cover cap. Drains at up to 0.5 l/sec. Seal water level 40mm			round	24 carat gold	87	215483R89	179,-
Low-profile waste outlet kit. 53mm construction height and cover cap. Drains at up to 0.5 l/sec. Seal water level 40mm			angled	White	87	215483S55	57,-
Waste outlet kit 70mm construction height and cover cap, drains at up to 0.6 l/sec. Seal water level 50mm			round	Chrome	104	215480R91	
Waste outlet kit 70mm construction height and cover cap, drains at up to 0.6 l/sec. Seal water level 50mm			round	White	104	215480R55	179,-
Waste outlet kit 70mm construction height and cover cap, drains at up to 0.6 l/sec. Seal water level 50mm			round	24 carat gold	104	215480R89	
Waste outlet kit 70mm construction height and cover cap, drains at up to 0.6 l/sec. Seal water level 50mm			angled	White	104	215480S55	57,-
Waste outlet kit 90mm construction height and cover cap, drains at up to 0.8 l/sec. Seal water level 50mm			round	Chrome	121	215481R91	
Waste outlet kit 90mm construction height and cover cap, drains at up to 0.8 l/sec. Seal water level 50mm			round	White	121	215481R55	179,-
Waste outlet kit 90mm construction height and cover cap, drains at up to 0.8 l/sec. Seal water level 50mm			round	24 carat gold	121	215481R89	
Waste outlet kit 90mm construction height and cover cap, drains at up to 0.8 l/sec. Seal water level 50mm			angled	White	121	215481S55	57,-
Flexible outlet pipe, connection diameter 50mm, lengths from 400mm to 1000mm						215482000	85,-
Tray pedestal for following dimensions:							
800 x 800	800	800			120-180 (85-120)	215490000	474,-
900 x 900	900	900			120-180 (85-120)	215491000	
1000 x 1000	1000	1000			120-180 (85-120)	215492000	
Flexible pedestal When ordering the flexible pedestal, state the precise dimensions of the shower tray.	800-1800	700-1000			120-180 (85-120)	215493000	663,-

Wall sealing systems - see HÜPPE EasyStyle Wall Covering section.

HÜPPE EasyFlat

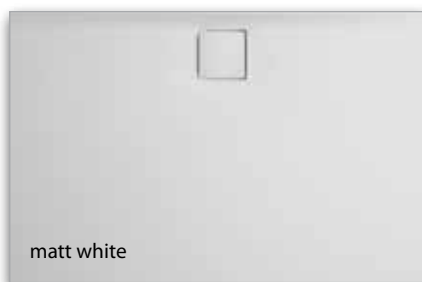
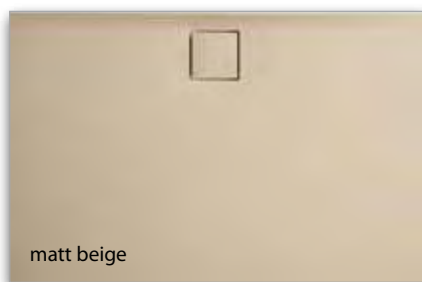
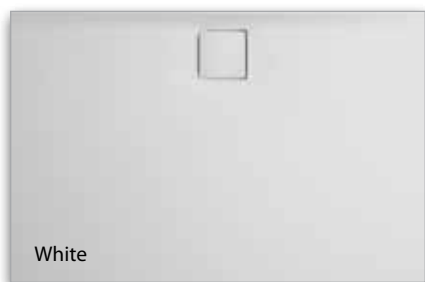

Available in five attractive colours.

Product details



Purist design: 100% flush-integrated draining cover made of high-grade cast-mineral. The drain cover is not only an optical highlight but also easy to clean thanks to the easy-to-clean Gelcoat surface.



Given that the tray is only 30mm high, HÜPPE EasyFlat is particularly suited for floor-flush, easy entry installation and is an easy-to-clean alternative to a tiled shower area.

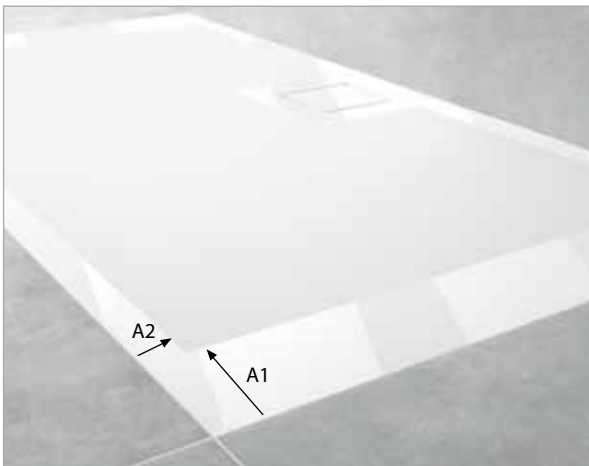

HÜPPE EasyFlat with special option HÜPPE EasyProtect (anti-slip surface) optionally available for colour white (055).

Distance tray edge to anti-slip area:

A1=140mm, A2=50mm

Anti-slip finish Analysis Group C for wet barefoot areas (**DIN 51097**).

Analysis Group R11 for anti-slip properties in working rooms and areas with a raised slipping risk level (**DIN 51130**).

The amount of residual water may increase with EasyProtect due to the surface tension. EasyProtect is a natural product. Small, dark cavities are therefore unavoidable.

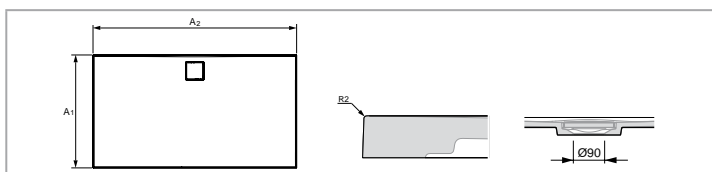

Shower tray:

- Tray dimensions comply with standard tolerances.
- The use of plastic mats may cause bubbles on the tray surface.

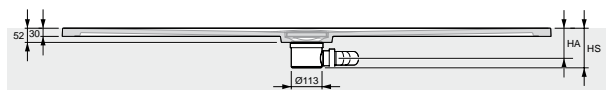

Floor-flush

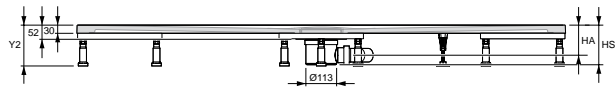

With tray pedestal

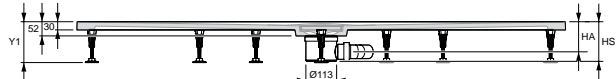

With tray feet

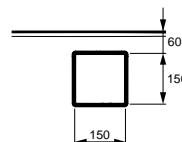
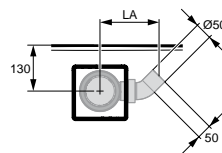

Shower tray

Tray size A2/A1	Distance tray feet Dimension L	Approx. weight in kg	Product no.	Base price
900 x 900	-	32	EF0101	775,-
1000 x 1000	350	39	EF0102	
1000 x 800	250	33	EF0103	
1000 x 900	250	35	EF0107	
1100 x 900	350	38	EF0108	
1200 x 800	280	38	EF0104	
1200 x 900	280	42	EF0109	
1200 x 1000	280	46	EF0116	902,-
1300 x 900	350	45	EF0110	
1400 x 800	350	43	EF0105	
1400 x 900	350	48	EF0111	
1400 x 1000	350	53	EF0117	
1500 x 900	450	51	EF0112	
1500 x 1000	450	56	EF0118	
1600 x 800	320	49	EF0106	1.068,-
1600 x 900	320	55	EF0113	
1600 x 1000	320	60	EF0119	
1700 x 900	450	58	EF0114	
1800 x 900	450	61	EF0115	
1800 x 1000	450	67	EF0120	

Special options

Optional variants		Extra charges	Extra charges A2 ≥ 1500
EasyProtect (available in colour white 055)	410	179,-	238,-

	Dimension	Siphon 53mm	Siphon 70mm	Siphon 90mm
Height of siphon connection	HA	84	92	112
Height with siphon	HS	109	126	143
Height with tray feet	Y1	120-135	120-135	120-135
Height with tray installation system	Y2	150-210 (115-150)	150-210 (115-150)	150-210 (115-150)
Space between siphon axis and the connecting pipe	LA	230	240	200

Tray colours

Profile colours	Colour code	Extra charges
grey matt	026	0,-
matt anthracite	028	
matt beige	037	
White	055	
matt white	083	

HÜPPE EasyFlat

Dimensions

Flexible pedestal

(A2/A1: see EasyFlat product page)

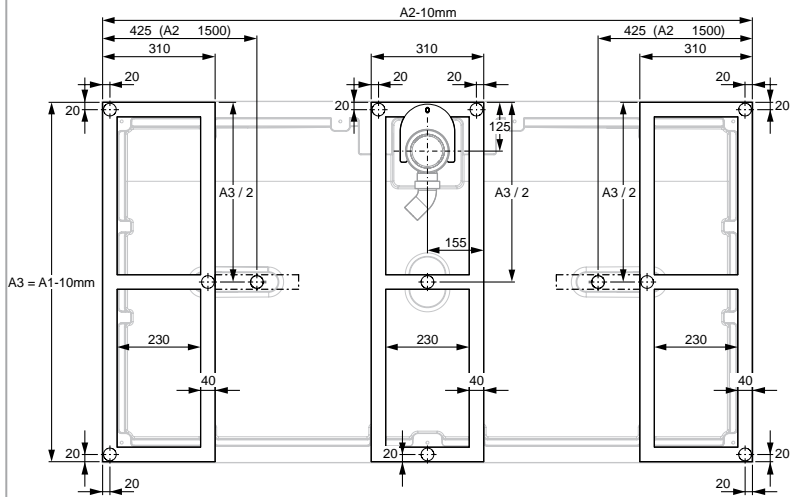
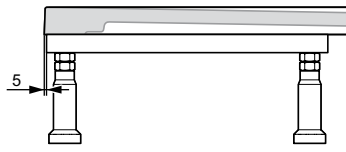

Tray pedestal for following dimensions:

900x900, 1000x1000

(A2/A1: see EasyFlat product page)

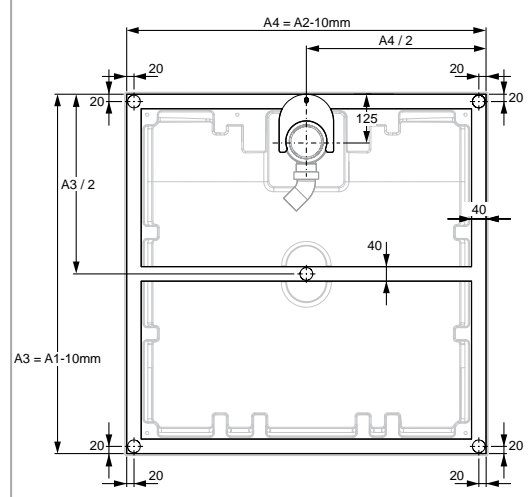
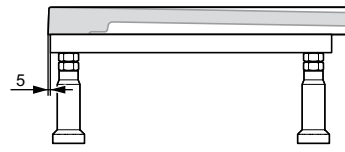

Underside EasyFlat/Position tray feet

(A2/A1 and L: see EasyFlat product page)

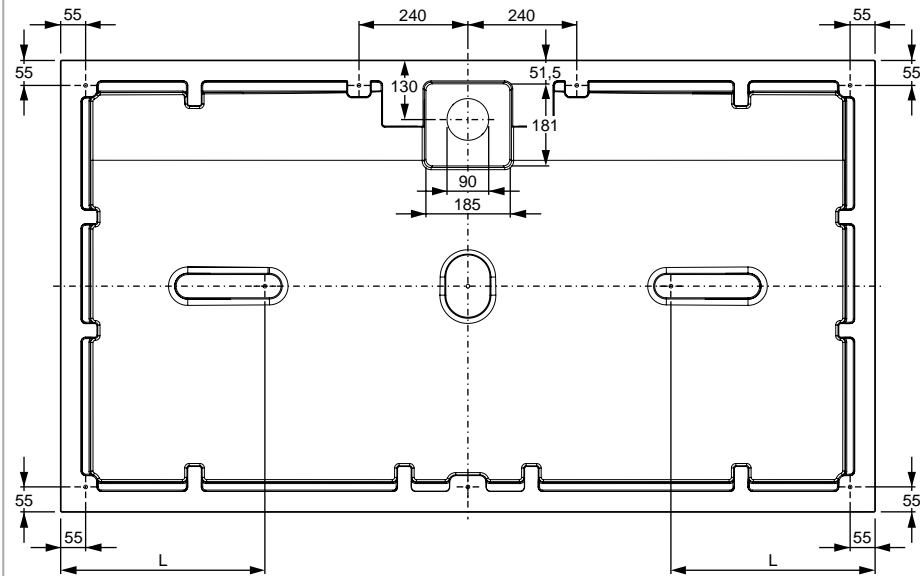

Extras

	A2	A1	Installation height incl. shower surface	Product no.	Price
Low-profile waste outlet kit 53mm construction height without cover cap, drains at up to 0.5 l/sec. Seal water level 40mm			109	200373000	57,-
Waste outlet kit 70mm construction height without cover cap, drains at up to 0.6 l/sec. Seal water level 50mm			126	200374000	
Waste outlet kit 90mm construction height without cover cap, drains at up to 0.8 l/sec. Seal water level 50mm			143	200375000	
Flexible outlet pipe, connection diameter 50mm, lengths from 400mm to 1000mm				215482000	85,-
Tray pedestal for following dimensions:					
900 x 900	900	900	120-180 (85-120)	215491000	474,-
1000 x 1000	1000	1000	120-180 (85-120)	215492000	
Flexible pedestal					
When ordering the flexible pedestal, state the precise dimensions of the shower tray.	800-1800	700-1000	120-180 (85-120)	215493000	663,-
Tray feet for 900x900 (5 pcs.)			120-135	200376000	57,-
Tray feet for all models (10 pcs.)			120-135	200377000	68,-

Wall sealing systems - see HÜPPE EasyStyle Wall Covering section.

HÜPPE EasyStyle wall coverings

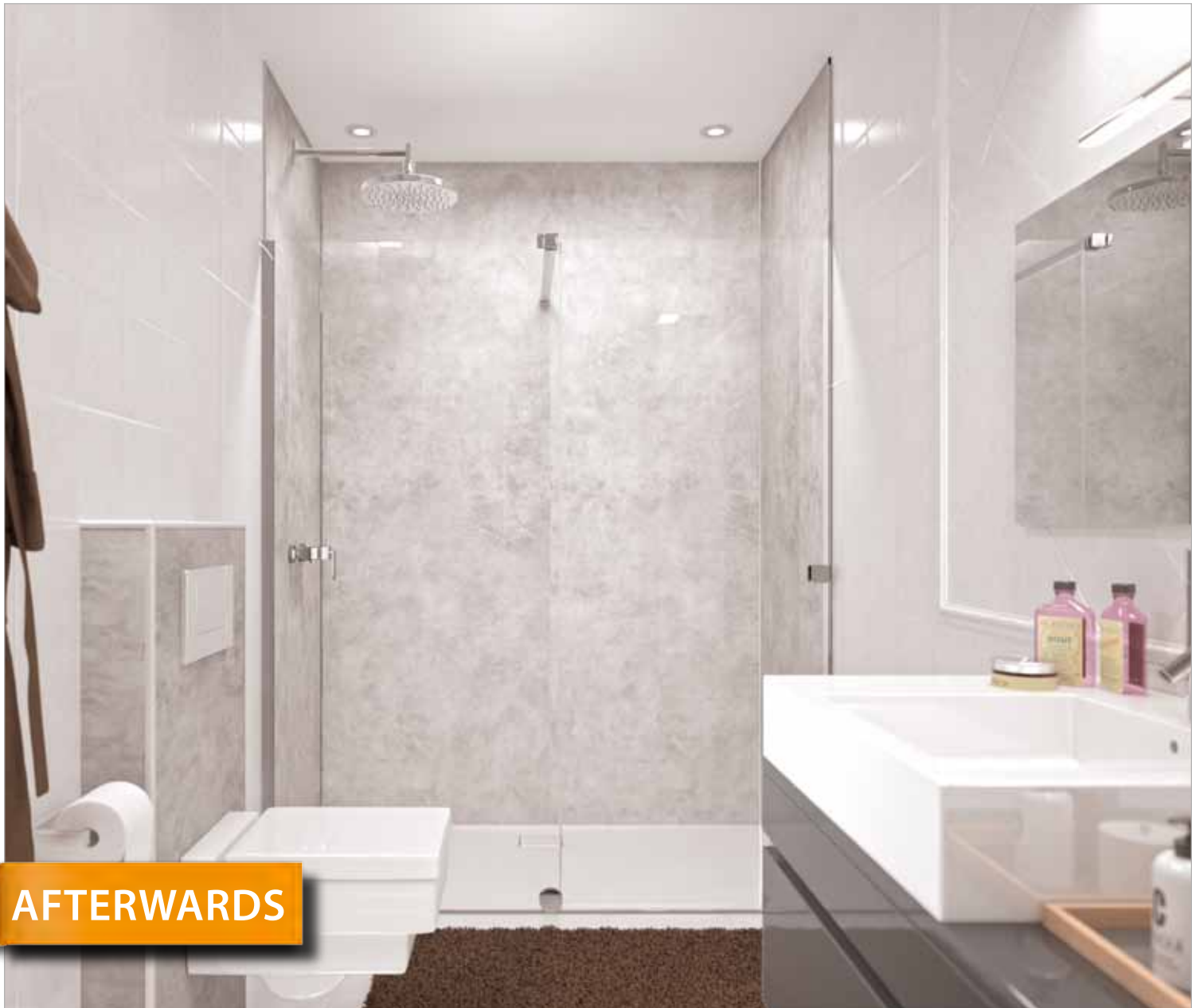

AFTERWARDS



BEFORE

The following components of the HÜPPE EasyStyle wall covering were used for this partial renovation:

Shower area:

- 4 x HÜPPE EasyStyle Concrete 41B decor
- 2 x internal corner profile matt silver
- 2 x end profile matt silver
- 1 x connecting profile matt silver

WC:

- 1 x HÜPPE EasyStyle Concrete 41B decor
- 2 x external corner profile matt silver
- 2 x set of 3 protection corner caps matt silver

Decors



HÜPPE EasyStyle Fine Marble 42D decor

EasyStyle B

Standard collection:



Matt white 42C



Fine marble 42D



Concrete 41B



Dark marble 42G



Pine limed 42A



Country spruce 42B

HÜPPE EasyStyle wall coverings



Foreground: HÜPPE EasyStyle Barcelona white 43B decor
Background: Barcelona Tiles black/white 43C decor

Barcelona Design collection:



Barcelona anthracite 43A



Barcelona white 43B



Barcelona grey beige 43D



Barcelona sand beige 43E



Barcelona brown 43G



Barcelona Tiles 43F

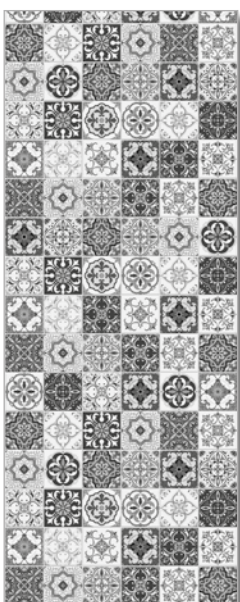

Barcelona Tiles black/white 43C

Italian Stone collection:



HÜPPE EasyStyle wall coverings



Left: Horses by Pöppelmann 44C decor
 Right: Italian Stone anthracite 41A decor

Delivery time: The delivery time for all "Print on Demand" decors is 25-30 working days.

"Print on Demand" decors:

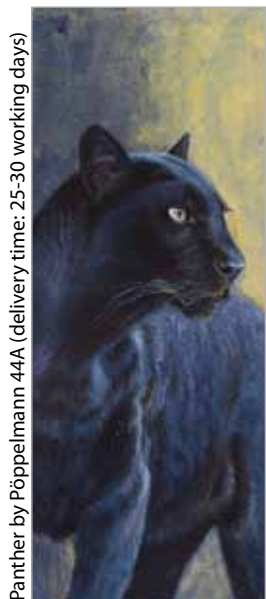

Decors



Custom decor (499)

Custom-designed
according to your
personal wishes.

Example

Custom decor:

In addition to the numerous decors in four stylish design collections, HÜPPE also offers custom decors based on the customer's wishes - personal photos or motifs purchased from an image database, for example. For best results, a resolution of at least 125 dpi is recommended. Precise technical details on request. Delivery time: 25-30 working days

HÜPPE EasyStyle wall coverings

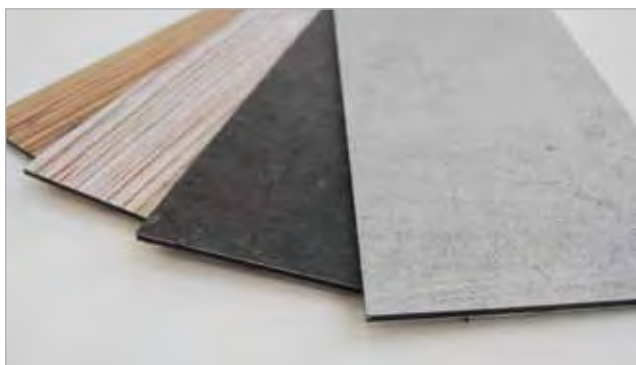

The 3mm thick aluminium composite panels with one-sided, digital printing directly on the panel and a surface finish with a UV paint coat are wear-resistant, colour-fast, scratch proof and resistant to chemicals.



HÜPPE EasyStyle wall covering is virtually joint-free with precision fitting thanks to the continuous decor.



Installation with different aluminium profiles is also available as an option. To connect the individual panels – including corner configurations – and for the side stops, aluminium profiles are available in 8 colours.

Profile colours

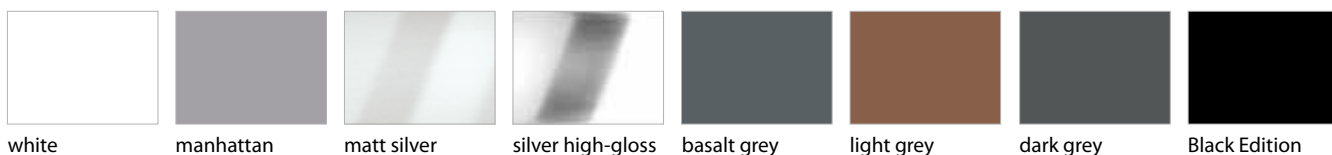

Product details

EasyStyle Select+ Profile

The HÜPPE EasyStyle wall covering can also be optionally combined and installed with the smart HÜPPE Select+ wall profile. The profiles are also available in 8 colours to match the colours of the standard EasyStyle profiles. Full details on Select+ and Select+ accessories can be found in the HÜPPE Select+ section. Available from summer 2020

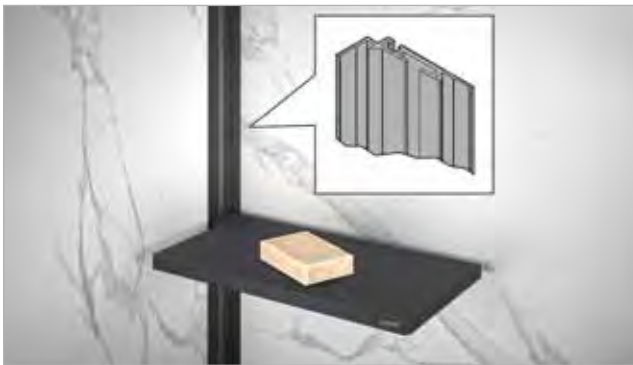

Internal corner profile for HÜPPE Select+ (ES0207)



Select+ connecting profile (ES0208)



HÜPPE Select+ end profile (ES0209)



Select+ Cover+ profile in grey and black

Profile colours - EasyStyle Select+ profile (and Cover+ profile colour)

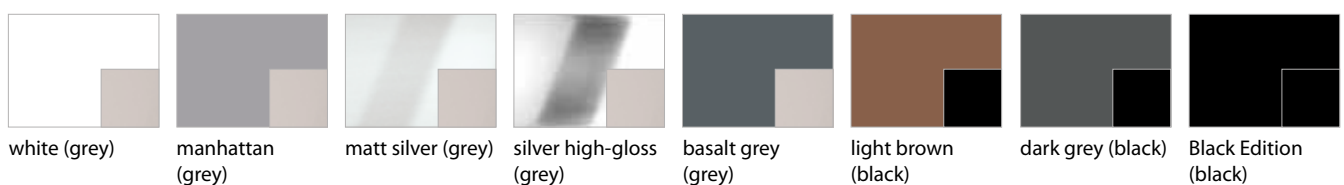



- Different production batches of EasyStyle may show slight colour variances. Such production related colour variances are excluded from return.

Wall covering

Height	Model	Width	Packaging unit	Product no.	Base price
2550	HÜPPE EasyStyle wall covering (set)	1000		ES0101	443,-
	HÜPPE EasyStyle wall covering (set)	1500		ES0102	665,-
	HÜPPE EasyStyle wall covering (set). Single decor and size type	1000	2nd box	ES0111	886,-
	HÜPPE EasyStyle wall covering (set). Single decor and size type	1500	2nd box	ES0112	1.330,-
	HÜPPE EasyStyle wall covering (set), mixed sizes, single decor type	1500/1000	2nd box	ES0121	1.108,-

The minimum order quantity is 2 pieces.

Profile colours

Profile colours	Colour code	Extra charges
Italian Stone anthracite	41A	0,-
Concrete	41B	
Italian Stone anthracite Tile	41D	
Italian Stone white	41F	
Italian Stone white Tile	41G	
Italian Stone grey beige Tile	41J	
Italian Stone sand beige	41L	
Italian Stone sand beige Tile	41M	
Italian Stone brown Tile	41P	
Italian Stone grey beige	41R	
Italian Stone brown	41S	
Pine limed	42A	

Profile colours	Colour code	Extra charges
Country spruce	42B	0,-
Matt white	42C	
Fine Marble	42D	
Dark Marble	42G	
Barcelona anthracite	43A	
Barcelona white	43B	
Barcelona Tiles black/white	43C	
Barcelona grey beige	43D	
Barcelona sand beige	43E	
Barcelona Tiles	43F	
Barcelona brown	43G	

Profile colours

Profile colours	Colour code	Extra charges
Italian Stone anthracite Vilar	41C	0,-
Italian Stone white Vilar	41E	
Italian Stone grey beige Vilar	41H	
Italian Stone sand beige Vilar	41K	
Italian Stone brown Vilar	41N	
Panther by Pöppelmann	44A	150,-
Zebras by Pöppelmann	44B	
Horses by Pöppelmann	44C	

Profile colours	Colour code	Extra charges
Elephant by Pöppelmann	44D	150,-
Peafowl by Pöppelmann	44E	
Aquarell	44F	
Ocean	44G	
Tree	44H	
Lakeside	44J	
Forrest	44K	
Individual decors according to your wishes	499	

Note: With these decors the delivery time is 25-30 working days.

General information:





Due to production conditions, slight colour variances may occur with different EasyStyle production batches. These colour variances occur most often in lighter and darker areas, which reflect the structure of the decor. Due to these batch-related colour variances and the different colour ranges mentioned, there may be deviations between the colours of the samples and the actual delivered product.

HÜPPE EasyStyle wall covering is untrimmed panelling with a +/-5mm outer dimension tolerance.

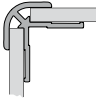
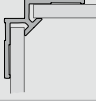

- Different production batches of EasyStyle may show slight colour variances. Such production related colour variances are excluded from return.

Profiles

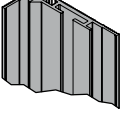
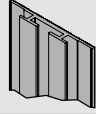
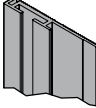
Model	Profile	Product no.	Price
Corner profile, outer		ES0201	73,-
Corner profile, inner		ES0202	
End profile		ES0203	
Connecting profile		ES0204	
3x protection corner cap		ES0205	35,-
2x protection corner cap		ES0206	
Corner profile for HÜPPE Select+		ES0207	71,-
Connecting profile Select+		ES0208	
HÜPPE Select+ end profile		ES0209	

Colours - Panel options

Profile colours	Colour code	Extra charges	Profile colours	Colour code	Extra charges
White	055	0,-	basalt grey	130	0,-
Manhattan grey	080		light grey	131	
Matt silver	087		dark grey	132	
silver gloss	116		Black Edition	123	

Special options

Optional variants	Packaging unit	Product no.	Extra charges
HÜPPE EasyStyle aluminium profiles and corner caps, single product type.*	10th box	P10	0,-

*Only applies to orders of 10 items or multiples of 10.

Accessories, installation

	Product no.	Price
Installation kit (silicone and adhesive strip - material for one plate)	ES0301	47,-
Two-component adhesive. (Consumption 6.5 kg container yields +/- 2.55 m ² with 5 x 5mm toothing). The precise consumption can vary according to the subsurface and toothing size.	ES0302	115,-
Adjusting shim set (installation aid)	ES0303	15,-



The HÜPPE EasyStyle sealing system:

- The HÜPPE EasyStyle sealing system is a revolutionary, self-adhesive sealing system made of polyolefin foam that does not require any tile adhesive.
- The flexible, crack-bridging seal prevents moisture damage at the transitions from the wall to the floor and around overlaps.
- The full-surface bonding and interlocking joints seal baths and showers perfectly.
- The system is self-adhesive, therefore HÜPPE EasyStyle wall covering can be affixed to it immediately, with no waiting time.
- Universal primer not required when installing on existing tiles.
- For projects where the DIN 18534 standard is specified the HÜPPE EasyStyle sealing system is to be used. For all other applications, the sealing system is not mandatory.

Accessory, seal

Model	Quantity		Product no.	Price
Wall sealing set with wall-fitting collars. 7,5m ² wall area.			ES0310	335,-
Wall sealing set with wall-fitting collars. 15m ² wall area.			ES0304	574,-
Tray sealing tape set with drip deflector. Length 6m.			ES0311	205,-
Supplementary tray sealing tape set for flush-fitting installation.	5 pcs.		ES0306	113,-
Accessory: Inside corner for sealing with the floor.	5 pcs.		ES0307	67,-
Accessory: Outside corner for sealing with the floor.	5 pcs.		ES0313	95,-
Accessory: Cut protection inner lining 10m.	1 pcs.		ES0314	159,-
Accessory: I-box collar.	1 pcs.		ES0312	50,-
Universal primer. Surface coverage up to 25m ² according to substrate.	5 kg		ES0308	154,-
Spray adhesive for 4-5m ² area. Ideal for repairing damaged areas of sealing tape, or for priming substrates with high levels of remaining moisture.	500ml		ES0309	62,-
Expansion zone assembly aid	20 pcs.		ES0315	

HÜPPE Select+



HÜPPE Select+ Organizer

The HÜPPE Select+ Organizer:

- are attached to the Select+ System on the wall profile
- are quick and easy to install, with no drilling
- can be installed at various heights
- are easy to clean due to the flush design
- can be combined and enhanced how you want
- are available in matt silver and Black Edition



HÜPPE Select+ Wiper



The HÜPPE Select+ Drybox reliably protects valuables against damp in the shower area.



The cover of the Select+ Drybox can be hung on the side.



The HÜPPE Select+ Tablet has space for shower utensils.



The HÜPPE Select+ Organizer does not interfere with cleaning and can be easily removed.

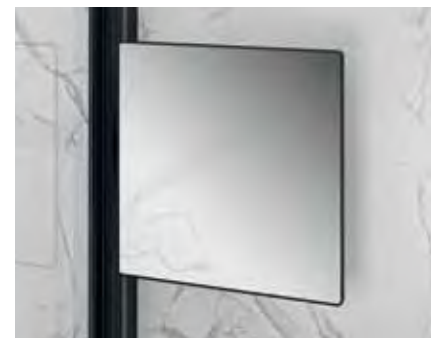

The HÜPPE Select+ Mirror has a large reflective area and can be adjusted to suit the user via the pivoting arm.



The HÜPPE Select+ Shower Board with integrated hand towel holder is attached to the side wall glass on one side using the patented HÜPPE clamping technology. The HÜPPE Select+ Shower Board can be universally retrofitted as a standalone item on any 6mm/8mm-thick side wall.



The HÜPPE Select+ "2 in 1" Shelf has space for a hand towel and a further storage option at the same time.



The HÜPPE Select+ Shelf sits flush with the inner surface, making the glass easy to clean after showering.

HÜPPE Select+



Rectangular

Free standing side panel, 10mm

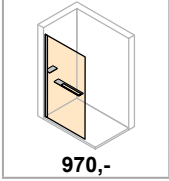

970,-

C.4-C.5

Free standing side panel, 8mm

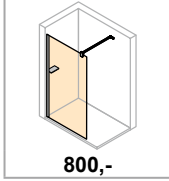

800,-

C.6-C.7

Free standing side panel, 6mm

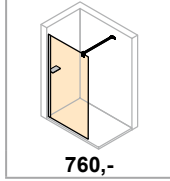

760,-

C.8-C.9

Select+ Organizer

HÜPPE Select+ Kit

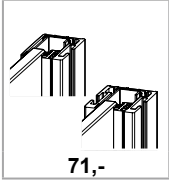

71,-

C.10-C.12

HÜPPE Select+ Organizer

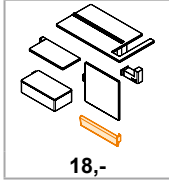

18,-

C.10-C.12

HÜPPE Select+

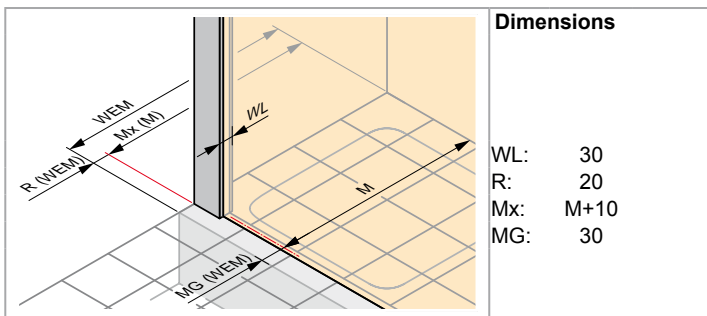
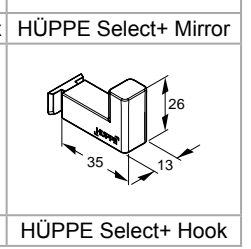
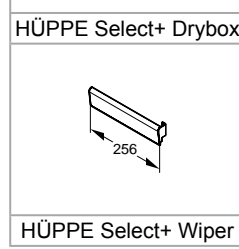
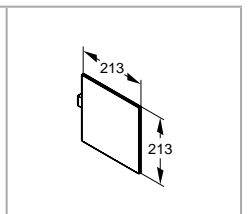
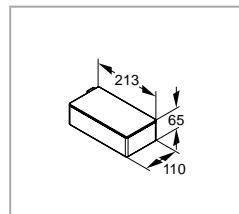
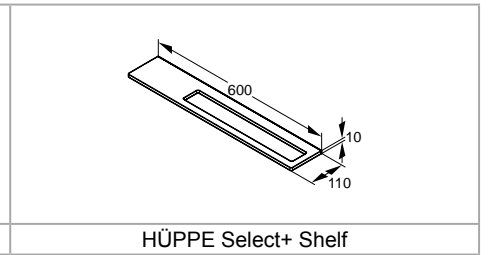
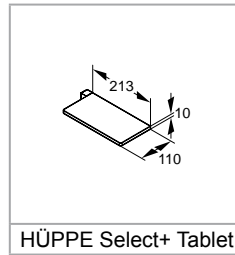
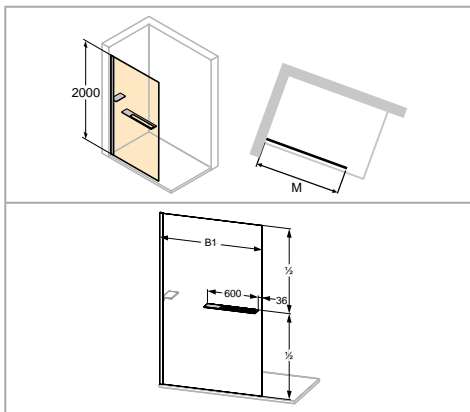

WEM = Tray installation dim. (000)
 M = installation dimension Centre glass (001)
 Please always specify when ordering.

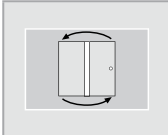
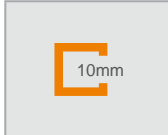

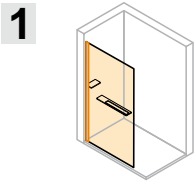
Free standing side panel, 10mm

Height	Model	Width B1	Product no.	Price
2000	SW 750	735-750	SL0101	970,-
	SW 800	785-800	SL0102	
	SW 900	885-900	SL0103	
	SW 1000	985-1000	SL0104	985,-
	SW 1100	1085-1100	SL0108	
	SW 1200	1185-1200	SL0105	
	SW 1300	1285-1300	SL0109	995,-
	SW 1400	1385-1400	SL0106	

Made-to-measure

Height	M (middle of glass)	Product no.	Price
200-2000	700-1200	SL0180	1.205,-
	1201-1400	SL0181	1.414,-

Standard equipment

Walk-in freestanding side wall with innovative HÜPPE Select+ wall profile, HÜPPE Select+ Tablet and HÜPPE Select+ Shelf.

With system colour 069 high gloss silver, the Select+ Organizers are supplied in colour 087 matt silver.

Colours - Panel options

Profile colours	Colour code	Extra charges	Panel options		without Anti-Plaque		with Anti-Plaque	
			Glass code	Extra charges	Glass code	Extra charges		
Silver high-gloss	069	0,-	Clear	321	0,-	322	209,-	
Matt silver	087							
Black Edition	123	171,-						

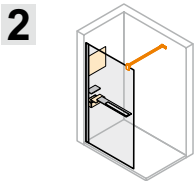
Select more Select+ organizers (optional)

	Colour	Product no.	Price
HÜPPE Select+ Tablet	Matt silver	SL2101087	99,-
HÜPPE Select+ Tablet	Black Edition	SL2101123	109,-
HÜPPE Select+ Drybox	Matt silver	SL2201087	119,-
HÜPPE Select+ Drybox	Black Edition	SL2201123	131,-
HÜPPE Select+ Mirror	Matt silver	SL2301087	159,-
HÜPPE Select+ Mirror	Black Edition	SL2301123	175,-
HÜPPE Select+ Wiper	Matt silver	SL2501087	30,-
HÜPPE Select+ Wiper	Black Edition	SL2501123	33,-
HÜPPE Select+ Hook	Matt silver	SL2701087	18,-
HÜPPE Select+ Hook	Black Edition	SL2701123	20,-
Cross-bracing (optional)	Matt silver	SL2601087	123,-
Cross-bracing (optional)	Black Edition	SL2601123	135,-

HÜPPE Select+

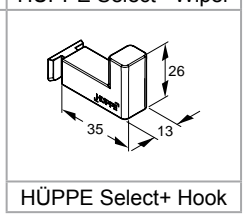
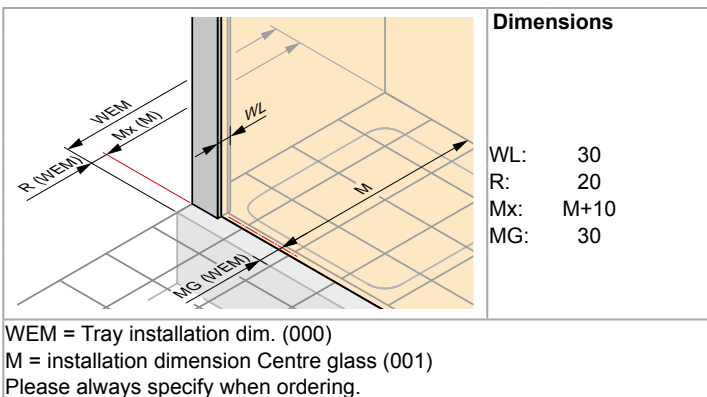
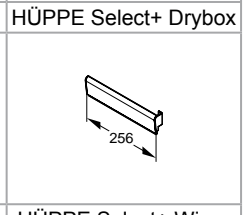
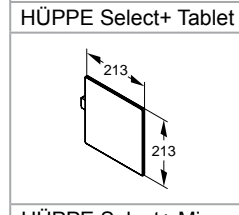
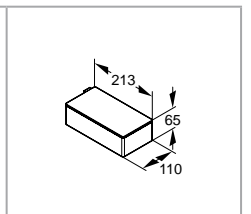
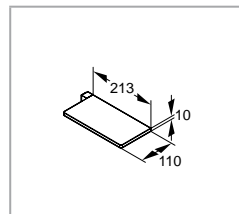
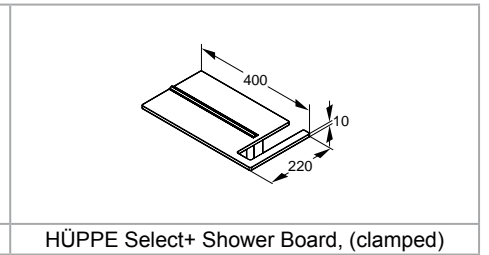
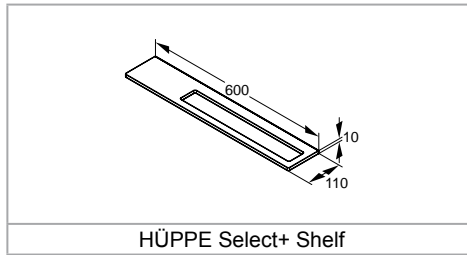
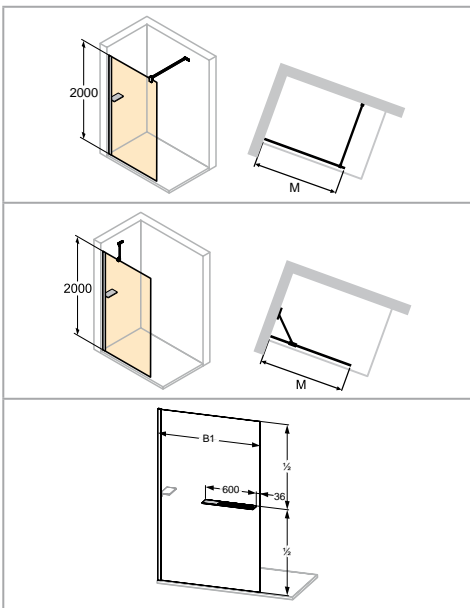

Free standing side panel, 8mm

1

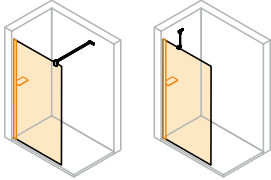

Height	Model	Fixing	Width B1	Product no.	Price
2000	SW 750	Cross-bracing	735-750	SL0301	
	SW 800	Cross-bracing	785-800	SL0302	800,-
	SW 900	Cross-bracing	885-900	SL0303	
	SW 1000	Cross-bracing	985-1000	SL0304	810,-
	SW 1100	Cross-bracing	1085-1100	SL0308	
	SW 1200	Cross-bracing	1185-1200	SL0305	820,-
	SW 1300	Cross-bracing	1285-1300	SL0309	
	SW 1400	Cross-bracing	1385-1400	SL0306	920,-
	SW 1600	Cross-bracing	1585-1600	SL0307	
	SW 750	Stabilizer	735-750	SL0311	
	SW 800	Stabilizer	785-800	SL0312	800,-
	SW 900	Stabilizer	885-900	SL0313	
	SW 1000	Stabilizer	985-1000	SL0314	810,-
	SW 1100	Stabilizer	1085-1100	SL0315	

Made-to-measure

Height	Fixing	M (middle of glass)	Product no.	Price
200-2000	Stabilizer	200-1100	SL0380	945,-
	Cross-bracing	200-1200	SL0381	995,-
	Cross-bracing	1201-1400	SL0382	1.220,-
	Cross-bracing	1401-1600	SL0383	1.432,-

With 880 variants the width must be > 700.

To use the Showerboard shower tray, the width must be > 400mm.

Standard equipment

Walk-in freestanding side wall with innovative HÜPPE Select+ wall profile and HÜPPE Select+ Tablet.

With system colour 069 high gloss silver, the Select+ Organizers are supplied in colour 087 matt silver.

Special options

Optional variants		Extra charges
HÜPPE Select+ Shelf	880	255,-

Colours - Panel options

Profile colours	Colour code	Extra charges	Panel options		without Anti-Plaque		with Anti-Plaque	
			Glass code	Extra charges	Glass code	Extra charges		
Silver high-gloss	069	0,-	Clear	321	0,-	322	209,-	
Matt silver	087							
Black Edition	123	171,-						

Select more Select+ organizers (optional)

2

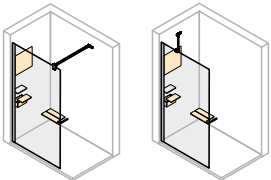

	Colour	Product no.	Price
HÜPPE Select+ Tablet	Matt silver	SL2101087	99,-
HÜPPE Select+ Tablet	Black Edition	SL2101123	109,-
HÜPPE Select+ Drybox	Matt silver	SL2201087	119,-
HÜPPE Select+ Drybox	Black Edition	SL2201123	131,-
HÜPPE Select+ Mirror	Matt silver	SL2301087	159,-
HÜPPE Select+ Mirror	Black Edition	SL2301123	175,-
HÜPPE Select+ Shower Board, (clamped)	Matt silver	SL2401087	204,-
HÜPPE Select+ Shower Board, (clamped)	Black Edition	SL2401123	224,-
HÜPPE Select+ Wiper	Matt silver	SL2501087	30,-
HÜPPE Select+ Wiper	Black Edition	SL2501123	33,-
HÜPPE Select+ Hook	Matt silver	SL2701087	18,-
HÜPPE Select+ Hook	Black Edition	SL2701123	20,-

HÜPPE Select+

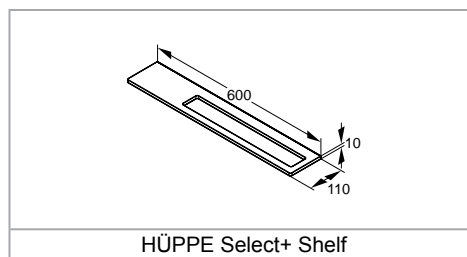
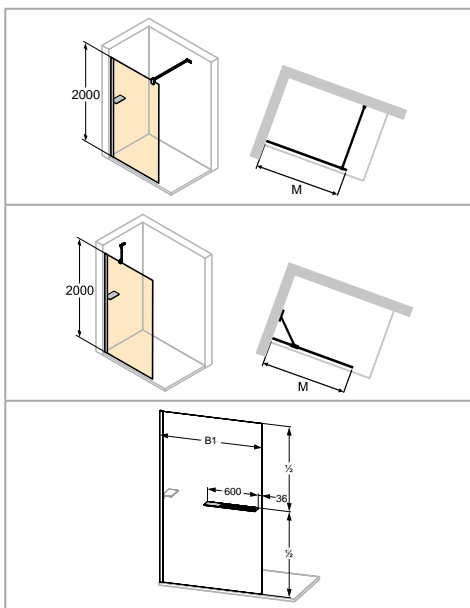

HÜPPE Select+ Shelf

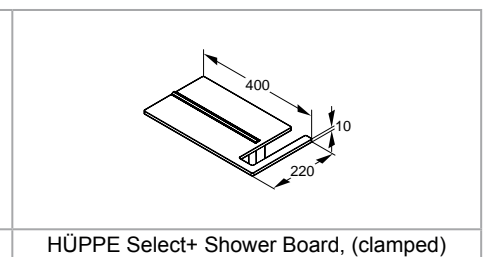

HÜPPE Select+ Shower Board, (clamped)

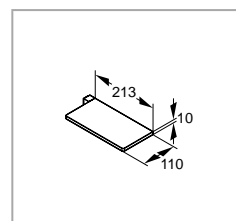

HÜPPE Select+ Tablet

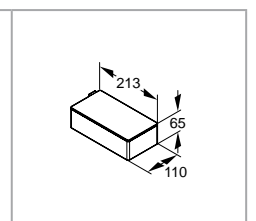

HÜPPE Select+ Drybox

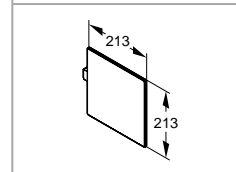

HÜPPE Select+ Mirror

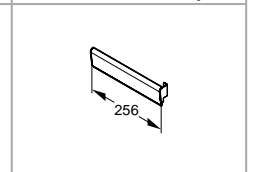

HÜPPE Select+ Wiper

Dimensions	
WL:	30
R:	20
Mx:	M+10
MG:	30

WEM = Tray installation dim. (000)
M = installation dimension Centre glass (001)
Please always specify when ordering.

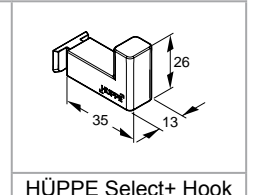

HÜPPE Select+ Hook



Free standing side panel, 6mm

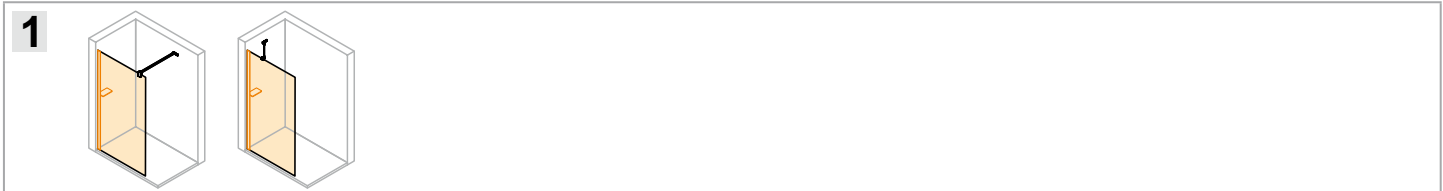

Height	Model	Fixing	Width B1	Product no.	Price
2000	SW 750	Cross-bracing	735-750	SL0201	760,-
	SW 800	Cross-bracing	785-800	SL0202	
	SW 900	Cross-bracing	885-900	SL0203	
	SW 1000	Cross-bracing	985-1000	SL0204	770,-
	SW 1100	Cross-bracing	1085-1100	SL0206	
	SW 1200	Cross-bracing	1185-1200	SL0205	
	SW 750	Stabilizer	735-750	SL0211	760,-
	SW 800	Stabilizer	785-800	SL0212	
	SW 900	Stabilizer	885-900	SL0213	
	SW 1000	Stabilizer	985-1000	SL0214	770,-
SW 1100	Stabilizer	1085-1100	SL0215		

Made-to-measure

Height	Fixing	M (middle of glass)	Product no.	Price
200-2000	Stabilizer	200-1100	SL0280	899,-
	Cross-bracing	200-1200	SL0281	937,-

With 880 variants the width must be > 700.

To use the Showerboard shower tray, the width must be > 400mm.

Standard equipment

Walk-in freestanding side wall with innovative HÜPPE Select+ wall profile and HÜPPE Select+ Tablet.

With system colour 069 high gloss silver, the Select+ Organizers are supplied in colour 087 matt silver.

Special options

Optional variants		Extra charges
HÜPPE Select+ Shelf	880	255,-

Colours - Panel options

Profile colours	Colour code	Extra charges	Panel options		without Anti-Plaque		with Anti-Plaque	
			Glass code	Extra charges	Glass code	Extra charges		
Silver high-gloss	069	0,-	Clear	321	0,-	322	209,-	
Matt silver	087							
Black Edition	123		171,-					

Select more Select+ organizers (optional)

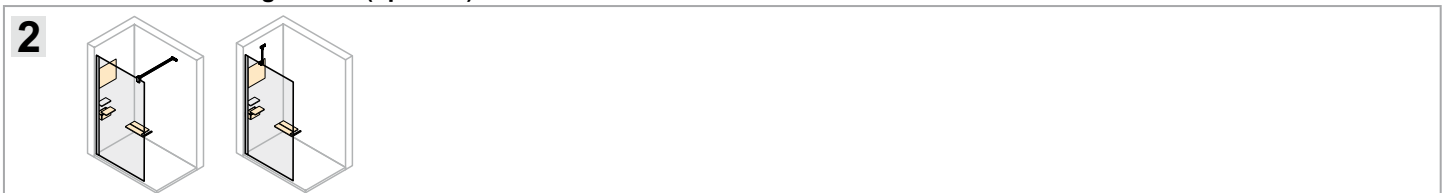

	Colour	Product no.	Price
HÜPPE Select+ Tablet	Matt silver	SL2101087	99,-
HÜPPE Select+ Tablet	Black Edition	SL2101123	109,-
HÜPPE Select+ Drybox	Matt silver	SL2201087	119,-
HÜPPE Select+ Drybox	Black Edition	SL2201123	131,-
HÜPPE Select+ Mirror	Matt silver	SL2301087	159,-
HÜPPE Select+ Mirror	Black Edition	SL2301123	175,-
HÜPPE Select+ Shower Board, (clamped)	Matt silver	SL2401087	204,-
HÜPPE Select+ Shower Board, (clamped)	Black Edition	SL2401123	224,-
HÜPPE Select+ Wiper	Matt silver	SL2501087	30,-
HÜPPE Select+ Wiper	Black Edition	SL2501123	33,-
HÜPPE Select+ Hook	Matt silver	SL2701087	18,-
HÜPPE Select+ Hook	Black Edition	SL2701123	20,-

Select+ Organizer

HÜPPE Select+ Kit

Höhe		Profilfarbe	Produkt-Nr.	Preis
1970	HÜPPE Select+ Kit for 8mm glass	Silver high-gloss	SL3103069	101,-
	HÜPPE Select+ Kit for 8mm glass	Matt silver	SL3103087	
	HÜPPE Select+ Kit for 8mm glass	Black Edition	SL3103123	
2000	HÜPPE Select+ Kit for 8mm glass	Silver high-gloss	SL3101069	101,-
	HÜPPE Select+ Kit for 8mm glass	Matt silver	SL3101087	
	HÜPPE Select+ Kit for 8mm glass	Black Edition	SL3101123	
2200	HÜPPE Select+ Kit for 8mm glass	Silver high-gloss	SL3102069	117,-
	HÜPPE Select+ Kit for 8mm glass	Matt silver	SL3102087	
	HÜPPE Select+ Kit for 8mm glass	Black Edition	SL3102123	
1970	HÜPPE Select+ Kit for 6mm glass	Silver high-gloss	SL3003069	101,-
	HÜPPE Select+ Kit for 6mm glass	Matt silver	SL3003087	
	HÜPPE Select+ Kit for 6mm glass	Black Edition	SL3003123	
2000	HÜPPE Select+ Kit for 6mm glass	Silver high-gloss	SL3001069	101,-
	HÜPPE Select+ Kit for 6mm glass	Matt silver	SL3001087	
	HÜPPE Select+ Kit for 6mm glass	Black Edition	SL3001123	
2200	HÜPPE Select+ Kit for 6mm glass	Silver high-gloss	SL3002069	117,-
	HÜPPE Select+ Kit for 6mm glass	Matt silver	SL3002087	
	HÜPPE Select+ Kit for 6mm glass	Black Edition	SL3002123	
2000	HÜPPE Select+ inside/outside profile for 10mm, 8mm and 6mm glass	Silver high-gloss	SL3201069	71,-
	HÜPPE Select+ inside/outside profile for 10mm, 8mm and 6mm glass	Matt silver	SL3201087	
	HÜPPE Select+ inside/outside profile for 10mm, 8mm and 6mm glass	Black Edition	SL3201123	

Adjustment range = dimensions - 15mm / + 0mm

With system colour 069 high gloss silver, the Select+ Organizers are supplied in colour 087 matt silver.

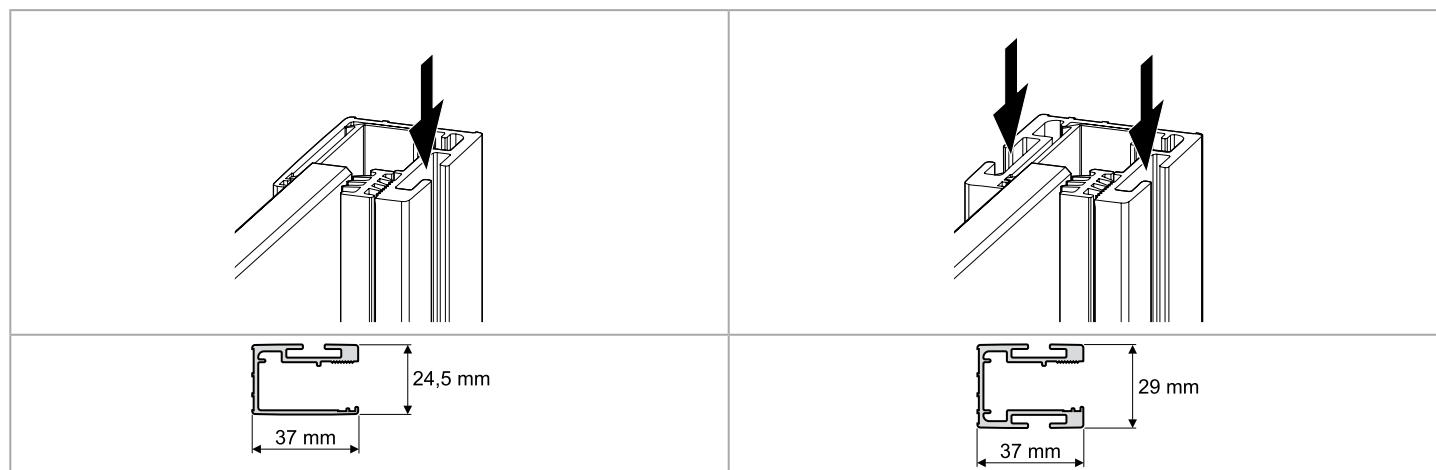

Select+ kit profile

Select+ inside/outside profile

* Only for free standing side panels in the pure/elegance and Design pure/elegance partially framed series.

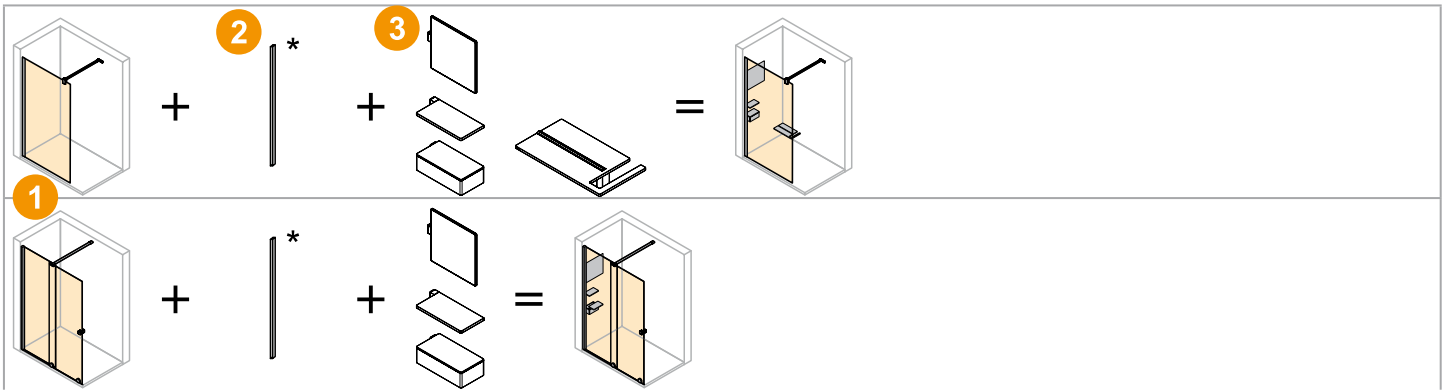

* = Select+ Kit

- 1** You have one of the side panels or door variants mentioned below from the corresponding series with a unit height of 2000mm/2200mm
- 2** Please order the HÜPPE Select+ Kit
- 3** Please order the requested HÜPPE Select+ Organizer

The HÜPPE Select+ Kit can be combined with:

- all free standing partially framed side panels with a glass thickness of 6mm or 8mm
- all models in the HÜPPE Xtensa pure series

All door variants with fixed segment and side panels in series:

- HÜPPE Solva pure partially framed
- HÜPPE Enjoy pure/elegance partially framed











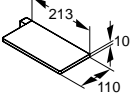

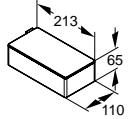
All door variants with fixed segment in series:

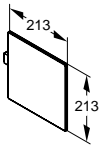
- HÜPPE Design pure/elegance

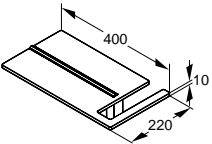
With the HÜPPE Select+ Kit, products from other HÜPPE series can be extended to a unique and convenient storage system. The HÜPPE Select+ Kit is ordered in addition to the shower enclosure and includes the innovative Select+ wall profile with the channel system, all the necessary sealing or clamping strips and the Select+ Cover profile for covering the channel system.

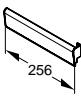
Select+ Organizer

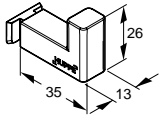
HÜPPE Select+ Organizer

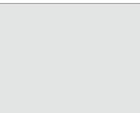
Höhe				Farbe	Produkt-Nr.	Preis
10			HÜPPE Select+ Tablet	Matt silver	SL2101087	99,-
			HÜPPE Select+ Tablet	Black Edition	SL2101123	109,-
65			HÜPPE Select+ Drybox	Matt silver	SL2201087	119,-
			HÜPPE Select+ Drybox	Black Edition	SL2201123	131,-
213			HÜPPE Select+ Mirror	Matt silver	SL2301087	159,-
			HÜPPE Select+ Mirror	Black Edition	SL2301123	175,-
10			HÜPPE Select+ Shower Board, (clamped)	Matt silver	SL2401087	204,-
			HÜPPE Select+ Shower Board, (clamped)	Black Edition	SL2401123	224,-
60			HÜPPE Select+ Wiper	Matt silver	SL2501087	30,-
			HÜPPE Select+ Wiper	Black Edition	SL2501123	33,-
26			HÜPPE Select+ Hook	Matt silver	SL2701087	18,-
			HÜPPE Select+ Hook	Black Edition	SL2701123	20,-

HÜPPE Alpha 2 fully framed model overview - Base price

Rectangular

Sliding door, 2-section
corner entry

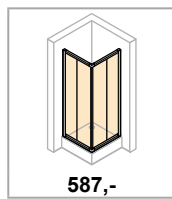

D.4-D.5

Sliding door, 3-section
corner entry

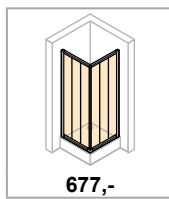

D.4-D.5

Sliding door, 2-section
corner entry (1/2)

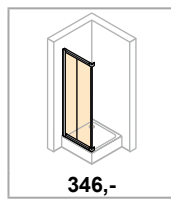

D.6-D.7

Sliding door, 3-section
corner entry (1/2)

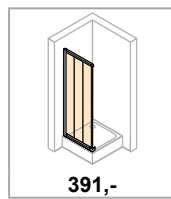

D.6-D.7

Sliding door, 1-panel
with fixed segment

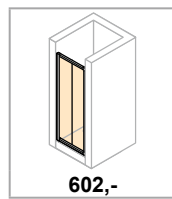

D.8-D.9

2-panel sliding door
with fixed segment

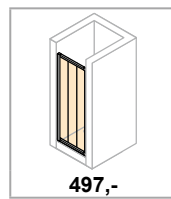

D.8-D.9

Sliding door, 3-panel,
all segments movable

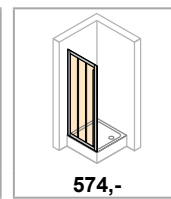

D.10-D.11

Swing door

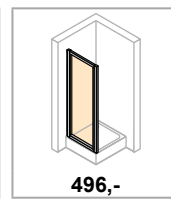

D.12-D.13

Two-way door

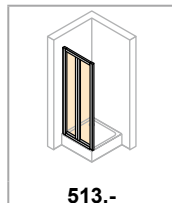

D.14-D.15

Two-way door with
additional section

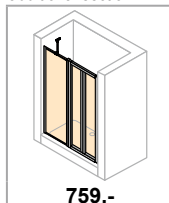

D.14-D.15

Side panel

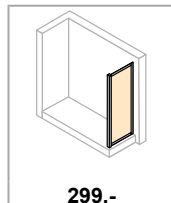

D.16-D.17

Quadrant

Sliding door

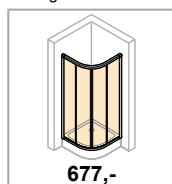

D.18-D.19

HÜPPE Alpha 2 partly framed model overview - Base price

Rectangular

Sliding door, 2-section corner entry

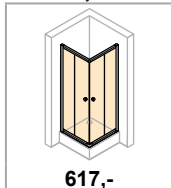

617,-

D.20-D.21

Sliding door, 3-section corner entry

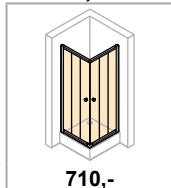

710,-

D.20-D.21

Sliding door, 2-section corner entry (1/2)

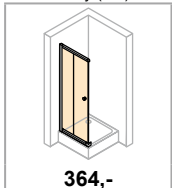

364,-

D.22-D.23

Sliding door, 3-section corner entry (1/2)

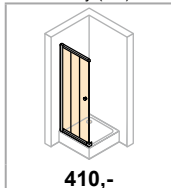

410,-

D.22-D.23

Sliding door, 1-panel with fixed segment

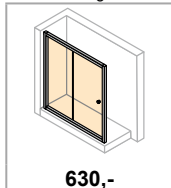

630,-

D.24-D.25

2-panel sliding door with fixed segment

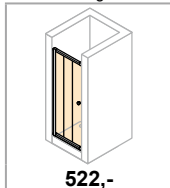

522,-

D.24-D.25

Swing door

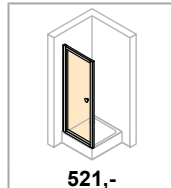

521,-

D.26-D.27

Two-way door

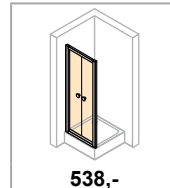

538,-

D.28-D.29

Two-way door with additional section

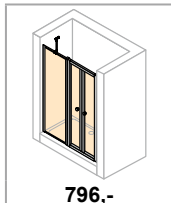

796,-

D.28-D.29

Side panel

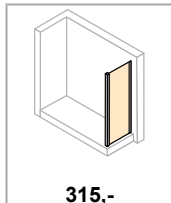

315,-

D.30-D.31

Quadrant

Sliding door

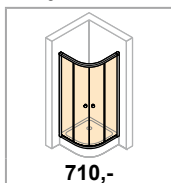

710,-

D.32-D.33

HÜPPE Alpha 2 fully framed
HÜPPE Alpha 2 partly framed



Product details



High quality chrome corner connector



Knob handle with partly framed version



Handle with fully framed version



High quality double rollers for smooth opening and closing of the sliding doors



Removable door segments for easy cleaning with all sliding door models



Easy installation technology due to the HÜPPE sealing system

- Patented, very simple installation using proven method
- No exposed screws in the vicinity of the wall profile

Corner connectors, knob handle and hinge cover caps always in high-gloss silver.

HÜPPE Alpha 2 fully framed Rectangular



Acrylic version



Glass version

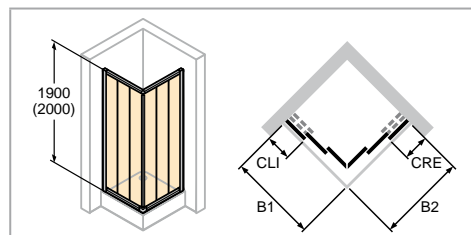
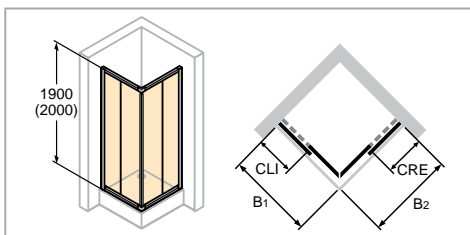

- Installation in U-shape possible, U-shape stabilizer set required.

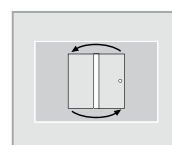
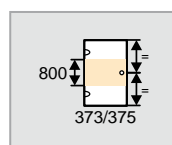
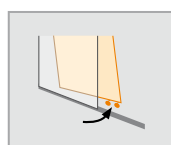
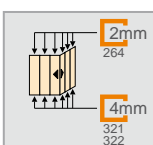
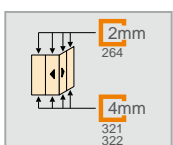
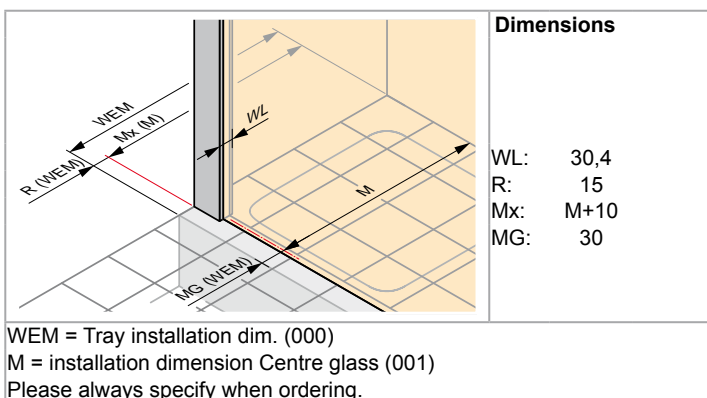

Sliding door, 2-section corner entry

Height	Model B1/B2	WEM B1	WEM B2	M (middle of glass) B1/B2	CLI	CRE	Entry width	Product no.	Base price
1900	700x700	685-710	685-710	655-680/655-680	332-357	332-357	363	A22011	587,-
	750x750	735-760	735-760	705-730/705-730	357-382	357-382	403	A22001	
	800x800	785-810	785-810	755-780/755-780	382-407	382-407	432	A22002	
	900x900	885-910	885-910	855-880/855-880	432-457	432-457	503	A22003	606,-
	1000x1000	985-1010	985-1010	955-980/955-980	482-507	482-507	573	A22004	
	750x900 900x750	735-760 885-910	885-910 735-760	705-730/855-880 855-880/705-730	357-382 432-457	432-457 357-382	451	A22009	
2000	700x700	685-710	685-710	655-680/655-680	332-357	332-357	363	A22012	649,-
	750x750	735-760	735-760	705-730/705-730	357-382	357-382	403	A22005	
	800x800	785-810	785-810	755-780/755-780	382-407	382-407	432	A22006	
	900x900	885-910	885-910	855-880/855-880	432-457	432-457	503	A22007	668,-
	1000x1000	985-1010	985-1010	955-980/955-980	482-507	482-507	573	A22008	
	750x900 900x750	735-760 885-910	885-910 735-760	705-730/855-880 855-880/705-730	357-382 432-457	432-457 357-382	451	A22013	

Made-to-measure

Height	Width B1/B2	Product no.	Base price
1200-2000	600-1250	A22080	764,-

Adjustment range = dimensions - 15mm / + 10mm

NOTE: With dimensions < 700mm x 700mm entry width ~ 300mm.

Sliding door, 3-section corner entry

Height	Model B1/B2	WEM B1	WEM B2	M (middle of glass) B1/B2	CLI	CRE	Entry width	Product no.	Base price
1900	700x700	685-710	685-710	655-680/655-680	227-252	227-252	416	A22608	677,-
	750x750	735-760	735-760	705-730/705-730	244-269	244-269	463	A22609	
	800x800	785-810	785-810	755-780/755-780	261-286	261-286	507	A22601	
	900x900	885-910	885-910	855-880/855-880	294-319	294-319	602	A22602	697,-
	1000x1000	985-1010	985-1010	955-980/955-980	328-353	328-353	697	A22603	
	750x900 900x750	735-760 885-910	885-910 735-760	705-730/855-880 855-880/705-730	244-269 294-319	294-319 244-269	533	A22607	
2000	700x700	685-710	685-710	655-680/655-680	227-252	227-252	416	A22610	748,-
	750x750	735-760	735-760	705-730/705-730	244-269	244-269	463	A22611	
	800x800	785-810	785-810	755-780/755-780	261-286	261-286	507	A22604	
	900x900	885-910	885-910	855-880/855-880	294-319	294-319	602	A22605	770,-
	1000x1000	985-1010	985-1010	955-980/955-980	328-353	328-353	697	A22606	
	750x900 900x750	735-760 885-910	885-910 735-760	705-730/855-880 855-880/705-730	244-269 294-319	294-319 244-269	533	A22612	



Made-to-measure

Height	Width B1/B2	Product no.	Base price
1200-2000	600-1250	A22680	879,-

Adjustment range = dimensions - 15mm / + 10mm

NOTE: With dimensions < 700mm x 700mm entry width ~ 300mm.

Extras

Height	Extras	Profile	Product no.	Price
1900	Extension profile, 15mm for wall profile with 30,4mm		141001	32,-
2000			A21005	
	U-shaped enclosure stabilizer set connecting side panel with wall (1 set, 2 pcs. each)		C26001	111,-

Colours - Panel options

Profile colours	Colour code	Extra charges	Panel options		without Anti-Plaque		with Anti-Plaque	
			Glass code	Extra charges	Glass code	Extra charges	Glass code	Extra charges
White	055	0,-	Styrene Pacific S clear	264	0,-			
Matt silver	087		Clear	321		322	418,-	
			Privatima	373		375	789,-	

HÜPPE Alpha 2 fully framed Rectangular



Acrylic version

Glass version

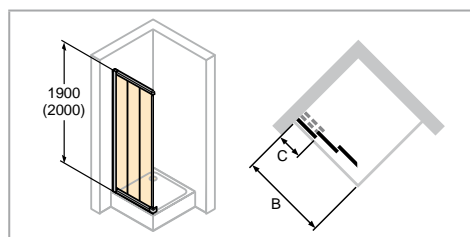
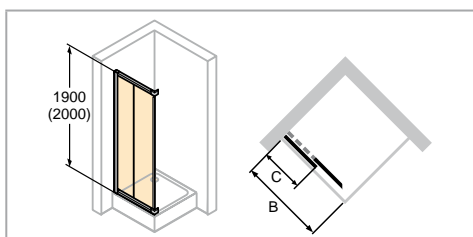

- Installation in U-shape possible, U-shape stabilizer set required.
- Sliding door, 2-section corner entry (1/2):**
- Combination not possible with corner entry sliding door, 3-panel (1/2).
- Sliding door, 3-section corner entry (1/2):**
- Combination not possible with corner entry sliding door, 2-panel (1/2).

	Dimensions
	<p>WL: 30,4 R: 15 Mx: M+10 MG: 30</p>
<p>WEM = Tray installation dim. (000) M = installation dimension Centre glass (001) Please always specify when ordering.</p>	

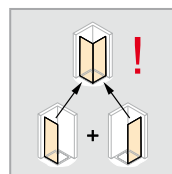
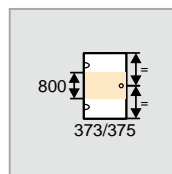
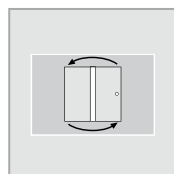
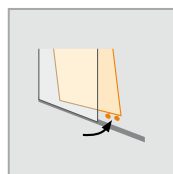
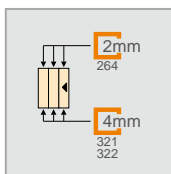
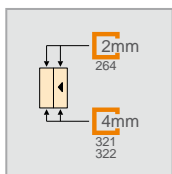

Sliding door, 2-section corner entry (1/2)

Height	Model	WEM B	M (middle of glass) B	C	Product no.	Base price
1900	700	685-710	655-680	332-357	A22101	346,-
	750	735-760	705-730	357-382	A22102	
	800	785-810	755-780	382-407	A22103	
	900	885-910	855-880	432-457	A22105	359,-
	1000	985-1010	955-980	482-507	A22107	
	1200	1185-1210	1155-1180	682-707	A22108	
2000	700	685-710	655-680	332-357	A22109	383,-
	750	735-760	705-730	357-382	A22110	
	800	785-810	755-780	382-407	A22111	
	900	885-910	855-880	432-457	A22112	396,-
	1000	985-1010	955-980	482-507	A22113	
	1200	1185-1210	1155-1180	682-707	A22114	

NOTE: The complete corner entry consists of two item nos.

Made-to-measure

Height	Width	Product no.	Base price
1200-2000	600-1250	A22180	451,-

Adjustment range = dimensions - 15mm / + 10mm

NOTE: With dimensions < 700mm x 700mm entry width ~ 300mm.

Sliding door, 3-section corner entry (1/2)

Height	Model	WEM B	M (middle of glass) B	C	Product no.	Base price
1900	700	685-710	655-680	227-252	A22701	391,-
	750	735-760	705-730	244-269	A22702	
	800	785-810	755-780	261-286	A22703	
	900	885-910	855-880	294-319	A22704	402,-
	1000	985-1010	955-980	328-353	A22705	
2000	700	685-710	655-680	227-252	A22706	431,-
	750	735-760	705-730	244-269	A22707	
	800	785-810	755-780	261-286	A22708	
	900	885-910	855-880	294-319	A22709	445,-
	1000	985-1010	955-980	328-353	A22710	

NOTE: The complete corner entry consists of two item nos.



Made-to-measure

Height	Width	Product no.	Base price
1200-2000	600-1250	A22780	508,-

Adjustment range = dimensions - 15mm / + 10mm

NOTE: With dimensions < 700mm x 700mm entry width ~ 300mm.

Extras

Height	Extras	Profile	Product no.	Price
1900	Extension profile, 15mm for wall profile with 30,4mm		141001	32,-
2000	Extension profile, 15mm for wall profile with 30,4mm		A21005	
	U-shaped enclosure stabilizer set connecting side panel with wall (1 set, 2 pcs. each)		C26001	111,-

Colours - Panel options

Profile colours	Colour code	Extra charges	Panel options		without Anti-Plaque		with Anti-Plaque	
			Glass code	Extra charges	Glass code	Extra charges		
White	055	0,-	Styrene Pacific S clear	264	0,-			
Matt silver	087		Clear	321		322	209,-	
			Privatima	373		375	395,-	

HÜPPE Alpha 2 fully framed Rectangular



Acrylic version



Acrylic version

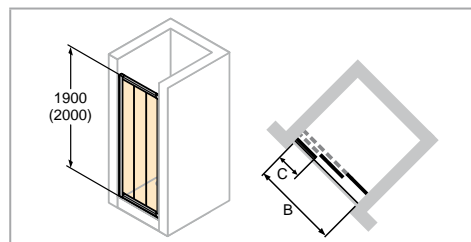
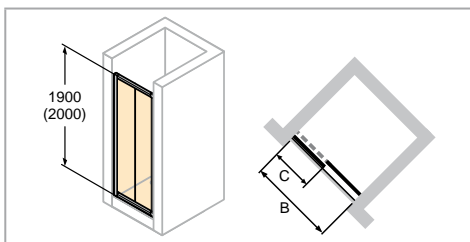

- Installation in U-shape possible, U-shape stabilizer set required.

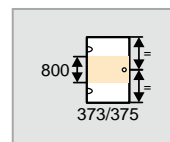
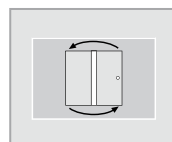
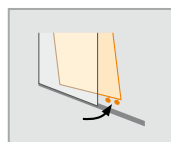
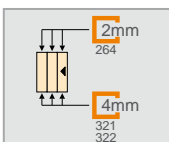
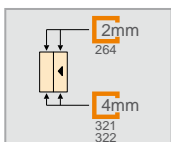
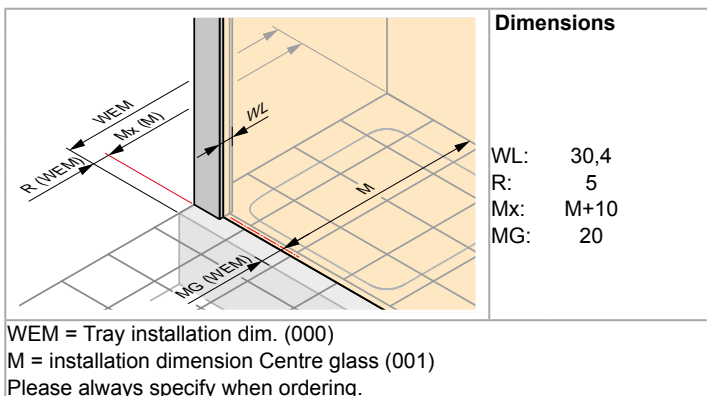

Sliding door, 1-panel with fixed segment

Height	Model	WEM In recess	WEM Side panel	M (middle of glass) Recess	M (middle of glass) Side panel	C	Entry width	Product no.	Base price	
1900	1000	970-1020	985-1030	970-1020	965-1010	475-500	393	A22301	602,-	
	1200	1170-1220	1185-1230	1170-1220	1165-1210	575-600	493	A22302		
	1300	1270-1320	1285-1330	1270-1320	1265-1310	625-650	543	A22303		
	1900	1400	1370-1420	1385-1430	1370-1420	1365-1410	675-700	593	A22304	656,-
		1500	1470-1520	1485-1530	1470-1520	1465-1510	725-750	643	A22305	
		1600	1570-1620	1585-1630	1570-1620	1565-1610	775-800	693	A22306	750,-
		1700	1670-1720	1685-1730	1670-1720	1665-1710	825-850	743	A22307	
2000	1000	970-1020	985-1030	970-1020	965-1010	475-500	393	A22308	879,-	
	1200	1170-1220	1185-1230	1170-1220	1165-1210	575-600	493	A22309		
	1300	1270-1320	1285-1330	1270-1320	1265-1310	625-650	543	A22310		
	2000	1400	1370-1420	1385-1430	1370-1420	1365-1410	675-700	593	A22311	665,-
		1500	1470-1520	1485-1530	1470-1520	1465-1510	725-750	643	A22312	
		1600	1570-1620	1585-1630	1570-1620	1565-1610	775-800	693	A22313	726,-
		1700	1670-1720	1685-1730	1670-1720	1665-1710	825-850	743	A22314	

Made-to-measure

Height	Width B	Product no.	Base price
1200-2000	1000-1800	A22380	828,-

Adjustment range GTN = dimensions - 30mm / + 20mm
Adjustment range GTS = dimensions - 15mm / + 30mm

2-panel sliding door with fixed segment



Height	Model	WEM In recess	WEM Side panel	M (middle of glass) Recess	M (middle of glass) Side panel	C	Entry width	Product no.	Base price	
1900	750	720-770	735-780	720-770	715-760	250-275	341	A22209	497,-	
	780	750-800	765-810	750-800	745-790	280-305	341	A22213	513,-	
	800	770-820	785-830	770-820	765-810	267-292	371	A22201		
	880	850-900	865-910	850-900	845-890	347-372	371	A22214		
	1900	900	870-920	885-930	870-920	865-910	300-325	437	A22203	529,-
		980	950-1000	965-1010	950-1000	945-990	380-405	437	A22215	
		1000	970-1020	985-1030	970-1020	965-1010	333-358	504	A22205	543,-
1200		1170-1220	1185-1230	1170-1220	1165-1210	400-425	641	A22210		
2000	750	720-770	735-780	720-770	715-760	250-275	341	A22211	549,-	
	780	750-800	765-810	750-800	745-790	280-305	341	A22216	567,-	
	800	770-820	785-830	770-820	765-810	267-292	371	A22206		
	880	850-900	865-910	850-900	845-890	347-372	371	A22217		
	2000	900	870-920	885-930	870-920	865-910	300-325	437	A22207	584,-
		980	950-1000	965-1010	950-1000	945-990	380-405	437	A22218	
		1000	970-1020	985-1030	970-1020	965-1010	333-358	504	A22208	601,-
1200		1170-1220	1185-1230	1170-1220	1165-1210	400-425	641	A22212		

Made-to-measure

Height	Width B	Product no.	Base price
1200-2000	700-1700	A22280	666,-

Adjustment range GTN = dimensions - 30mm / + 20mm
Adjustment range GTS = dimensions - 15mm / + 30mm
NOTE: With dimension 700mm entry width only ~ 300mm.

Extras

Height	Extras	Profile	Product no.	Price
1900	Extension profile, 15mm for wall profile with 30,4mm		141001	32,-
2000			A21005	
	U-shaped enclosure stabilizer set connecting side panel with wall (1 set, 2 pcs. each)		C26001	111,-

Colours - Panel options

Profile colours	Colour code	Extra charges	Panel options		without Anti-Plaque		with Anti-Plaque	
			Glass code	Extra charges	Glass code	Extra charges	Glass code	Extra charges
White	055	0,-	Styrene Pacific S clear	264	0,-			
Matt silver	087		Clear	321		322	209,-	
			Privatima	373		375	395,-	

HÜPPE Alpha 2 fully framed Rectangular



Acrylic version



Glass version

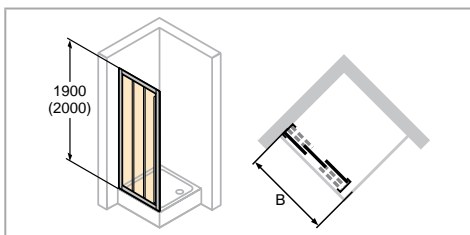

- Installation in U-shape possible, U-shape stabilizer set required.

Dimensions

WL: 30,4
R: 5
Mx: M+10
MG: 20

WEM = Tray installation dim. (000)
M = installation dimension Centre glass (001)
Please always specify when ordering.

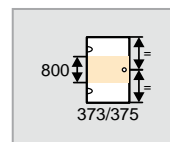
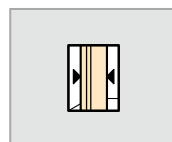
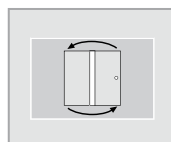
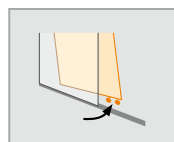
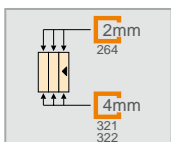

Sliding door, 3-panel, all segments movable

Height	Model	WEM In recess	WEM Side panel	M (middle of glass) Recess	M (middle of glass) Side panel	Entry width	Product no.	Base price
1900	800	770-820	785-830	770-820	765-810	346	A24301	574,-
	900	870-920	885-930	870-920	865-910	413	A24302	
	1000	970-1020	985-1030	970-1020	965-1010	480	A24303	596,-
	1200	1170-1220	1185-1230	1170-1220	1165-1210	613	A24304	617,-
2000	800	770-820	785-830	770-820	765-810	346	A24305	634,-
	900	870-920	885-930	870-920	865-910	413	A24306	
	1000	970-1020	985-1030	970-1020	965-1010	480	A24307	658,-
	1200	1170-1220	1185-1230	1170-1220	1165-1210	613	A24308	682,-



Made-to-measure

Height	Width B	Product no.	Base price
1200-2000	800-1800	A24380	747,-

Adjustment range GTN = dimensions - 30mm / + 20mm

Adjustment range GTS = dimensions - 15mm / + 30mm

Extras

Height	Extras	Profile	Product no.	Price
1900	Extension profile, 15mm for wall profile with 30,4mm		141001	32,-
2000	Extension profile, 15mm for wall profile with 30,4mm		A21005	
	U-shaped enclosure stabilizer set connecting side panel with wall (1 set, 2 pcs. each)		C26001	111,-

Colours - Panel options

Profile colours	Colour code	Extra charges	Panel options		without Anti-Plaque		with Anti-Plaque	
			Glass code	Extra charges	Glass code	Extra charges	Glass code	Extra charges
White	055	0,-	Styrene Pacific S clear	264	0,-			
Matt silver	087		Clear	321		322	209,-	
			Privatima	373		375	395,-	

HÜPPE Alpha 2 fully framed Rectangular

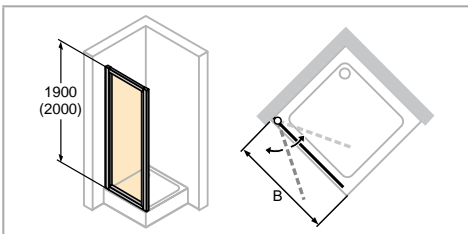

- Installation in U-shape possible, U-shape stabilizer set required.

Dimensions	
	WL: 30,4 R: 5 Mx: M+10 MG: 20
WEM = Tray installation dim. (000) M = installation dimension Centre glass (001) Please always specify when ordering.	

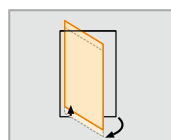
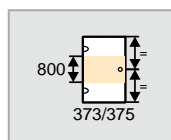
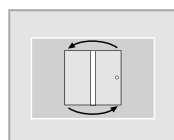
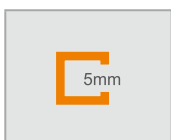



Swing door

Height	Model	WEM In recess	WEM Side panel	M (middle of glass) Recess	M (middle of glass) Side panel	Entry width	Product no.	Base price
1900	700	674-720	685-730	674-720	665-710	559	A24407	496,-
	750	724-770	735-780	724-770	715-760	610	A24408	
	780	754-800	765-810	754-800	745-790	640	A24411	513,-
	800	774-820	785-830	774-820	765-810	659	A24401	
	880	854-900	865-910	854-900	845-890	740	A24412	
	900	874-920	885-930	874-920	865-910	759	A24402	
	980	954-1000	965-1010	954-1000	945-990	840	A24413	529,-
	1000	974-1020	985-1030	974-1020	965-1010	859	A24403	
2000	700	674-720	685-730	674-720	665-710	559	A24409	546,-
	750	724-770	735-780	724-770	715-760	610	A24410	
	780	754-800	765-810	754-800	745-790	640	A24414	567,-
	800	774-820	785-830	774-820	765-810	659	A24404	
	880	854-900	865-910	854-900	845-890	740	A24415	
	900	874-920	885-930	874-920	865-910	759	A24405	
	980	954-1000	965-1010	954-1000	945-990	840	A24416	584,-
	1000	974-1020	985-1030	974-1020	965-1010	859	A24406	

Made-to-measure

Height	Width B	Product no.	Base price
1200-2000	600-1000	A24480	666,-
Adjustment range STN = dimensions - 26mm / + 20mm			
Adjustment range STS = dimensions - 15mm / + 30mm			

Extras

Height	Extras	Profile	Product no.	Price
1900	Extension profile, 15mm for wall profile with 30,4mm		141001	32,-
2000			A21005	
	U-shaped enclosure stabilizer set connecting side panel with wall (1 set, 2 pcs. each)		C26001	111,-

Colours - Panel options

Profile colours	Colour code	Extra charges	Panel options		without Anti-Plaque		with Anti-Plaque	
					Glass code	Extra charges	Glass code	Extra charges
White	055	0,-	Clear		321	0,-	322	209,-
Matt silver	087		Privatima		373	186,-	375	395,-

HÜPPE Alpha 2 fully framed Rectangular



Acrylic version



Glass version

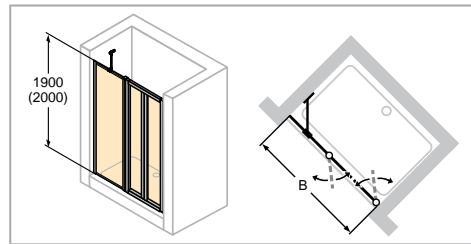
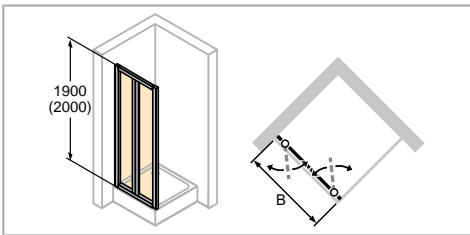

- Installation in U-shape possible, U-shape stabilizer set required.

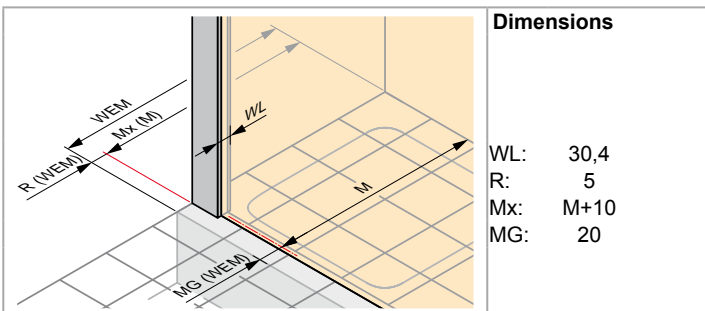

WEM = Tray installation dim. (000)
 M = installation dimension Centre glass (001)
 Please always specify when ordering.

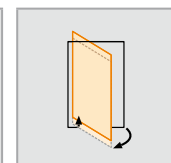
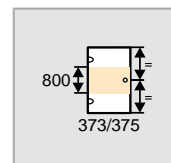
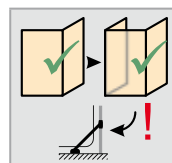
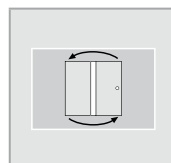
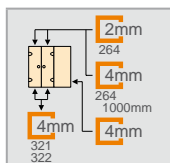
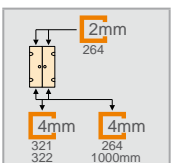

Two-way door

Height	Model	WEM In recess	WEM Side panel	M (middle of glass) Recess	M (middle of glass) Side panel	Entry width	Product no.	Base price	
1900	700	674-720	685-730	674-720	665-710	520	A24501	513,-	
	750	724-770	735-780	724-770	715-760	570	A24502		
	780	754-800	765-810	754-800	745-790	610	A24513		
	800	774-820	785-830	774-820	765-810	620	A24503		
	880	854-900	865-910	854-900	845-890	710	A24514		
	900	874-920	885-930	874-920	865-910	720	A24504		
	980	954-1000	965-1010	954-1000	945-990	810	A24515	529,-	
	1000	974-1020	985-1030	974-1020	965-1010	820	A24505	538,-	
2000	1200	1174-1220	1185-1230	1174-1220	1165-1210	1020	A24506	567,-	
	700	674-720	685-730	674-720	665-710	520	A24507		
	750	724-770	735-780	724-770	715-760	570	A24508		
	780	754-800	765-810	754-800	745-790	610	A24516		
	800	774-820	785-830	774-820	765-810	620	A24509		
	880	854-900	865-910	854-900	845-890	710	A24517		
	900	874-920	885-930	874-920	865-910	720	A24510		
	980	954-1000	965-1010	954-1000	945-990	810	A24518		
	1000	974-1020	985-1030	974-1020	965-1010	820	A24511		584,-
	1200	1174-1220	1185-1230	1174-1220	1165-1210	1020	A24512		595,-

Made-to-measure

Height	Width B	Product no.	Base price
1200-2000	600-1200	A24580	666,-

Adjustment range STN = dimensions - 26mm / + 20mm
Adjustment range PTS = dimensions - 15mm / + 30mm

Two-way door with additional section



Height	Model	WEM In recess	WEM Side panel	M (middle of glass) Recess	M (middle of glass) Side panel	Entry width	Product no.	Base price
1900	1200	1144-1240	1155-1250	1144-1240	1135-1230	620	A24601	759,-
	1300	1244-1340	1255-1350	1244-1340	1235-1330	620	A24602	
	1400	1344-1440	1355-1450	1344-1440	1335-1430	620	A24603	
	1500	1444-1540	1455-1550	1444-1540	1435-1530	720	A24604	774,-
	1600	1544-1640	1555-1650	1544-1640	1535-1630	820	A24605	
	1700	1644-1740	1655-1750	1644-1740	1635-1730	1020	A24606	789,-
	1800	1744-1840	1755-1850	1744-1840	1735-1830	1020	A24607	
2000	1200	1144-1240	1155-1250	1144-1240	1135-1230	620	A24608	838,-
	1300	1244-1340	1255-1350	1244-1340	1235-1330	620	A24609	
	1400	1344-1440	1355-1450	1344-1440	1335-1430	620	A24610	
	1500	1444-1540	1455-1550	1444-1540	1435-1530	720	A24611	854,-
	1600	1544-1640	1555-1650	1544-1640	1535-1630	820	A24612	
	1700	1644-1740	1655-1750	1644-1740	1635-1730	1020	A24613	872,-
	1800	1744-1840	1755-1850	1744-1840	1735-1830	1020	A24614	

Made-to-measure

Height	Width B	Product no.	Base price
1200-2000	1000-2000	A24680	978,-

Adjustment range STN = dimensions - 56mm / + 40mm
Adjustment range PTS = dimensions - 45mm / + 50mm
The width of the additional section must be stated.

Extras

Height	Extras	Profile	Product no.	Price
1900	Extension profile, 15mm for wall profile with 30,4mm		141001	32,-
2000			A21005	
	U-shaped enclosure stabilizer set connecting side panel with wall (1 set, 2 pcs. each)		C26001	111,-

Colours - Panel options

Profile colours	Colour code	Extra charges	Panel options		without Anti-Plaque		with Anti-Plaque	
			Glass code	Extra charges	Glass code	Extra charges		
White	055	0,-	Styrene Pacific S clear	264	0,-			
Matt silver	087		Clear	321		322	209,-	
			Privatima	373		375	395,-	

HÜPPE Alpha 2 fully framed Rectangular

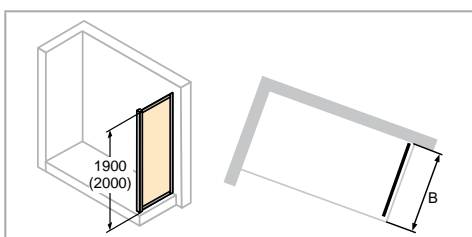

- Cannot be ordered as a free-standing side panel.
- Styrene 264 only available up to a width of 1000mm (tray installation dimension) / 980mm (assembly middle of glass).

Dimensions

WL:	30,4	20
R:	5	5
Mx:	M+10	M+10
MG:	20	20

WEM = Tray installation dim. (000)
M = installation dimension Centre glass (001)
Please always specify when ordering.

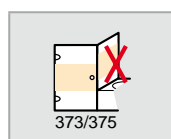
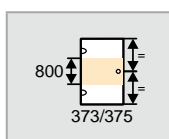
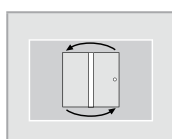
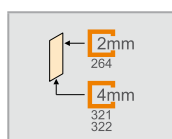

Side panel

Height	Model	WEM B	M (middle of glass) B	Product no.	Base price
1900	SW 700	685-710	665-690	A22401	299,-
	SW 750	735-760	715-740	A22402	
	SW 780	765-790	745-770	A22415	
	SW 800	785-810	765-790	A22403	
	SW 880	865-890	845-870	A22416	308,-
	SW 900	885-910	865-890	A22405	
	SW 980	965-990	945-970	A22417	
	SW 1000	985-1010	965-990	A22407	
2000	SW 700	685-710	665-690	A22418	331,-
	SW 750	735-760	715-740	A22419	
	SW 780	765-790	745-770	A22420	
	SW 800	785-810	765-790	A22421	
	SW 880	865-890	845-870	A22422	340,-
	SW 900	885-910	865-890	A22423	
	SW 980	965-990	945-970	A22424	
	SW 1000	985-1010	965-990	A22425	

Made-to-measure

Height	Model	Glass width B	Acrylic B width	Product no.	Base price
500-2000	Standard made-to-measure	200-1200	200-1000	A22480	401,-
	In-line configuration	200-1200	200-1000	A22481	
	On bathtub	200-1200	200-1000	A22482	

Adjustment range = dimensions - 15mm / + 10mm

Slopes and cut-outs

Slopes and cut-outs	Extra charges
 Supplement per slope/cut-out for made-to-measure	170,-

Colours - Panel options

Profile colours	Colour code	Extra charges	Panel options	without Anti-Plaque		with Anti-Plaque	
				Glass code	Extra charges	Glass code	Extra charges
White	055	0,-	Styrene Pacific S clear	264	0,-		
Matt silver	087		Clear	321		322	209,-
			Privatima	373		375	395,-

HÜPPE Alpha 2 fully framed Quadrant



Acrylic version



Glass version

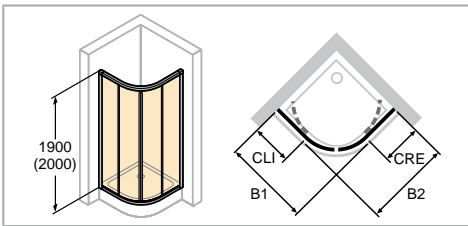

- Installation in U-shape possible, U-shape stabilizer set required.

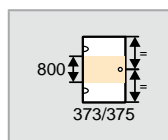
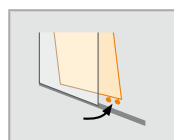
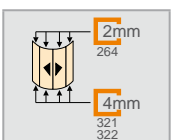
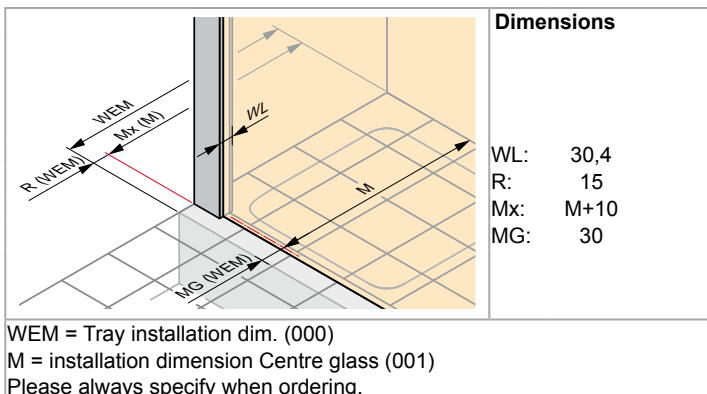

Sliding door



Height	Model B1/B2	WEM B1	WEM B2	M (middle of glass) B1/B2	CLI	CRE	Entry width	Radius	Product no.	Base price
1900	800 x 800	785-810	785-810	755-780/755-780	280-305	280-305	420	500	A22501	677,-
	900 x 900	885-910	885-910	855-880/855-880	380-405	380-405	540	500	A22502	
	1000 x 1000	985-1010	985-1010	955-980/955-980	480-505	480-505	540	500	A22505	697,-
	800 x 800	785-810	785-810	755-780/755-780	237-262	237-262	350	550	A22503	677,-
	900 x 900	885-910	885-910	855-880/855-880	337-362	337-362	490	550	A22504	
2000	1000 x 1000	985-1010	985-1010	955-980/955-980	437-462	437-462	490	550	A22506	697,-
	800 x 800	785-810	785-810	755-780/755-780	280-305	280-305	420	500	A22511	748,-
	900 x 900	885-910	885-910	855-880/855-880	380-405	380-405	540	500	A22512	
	1000 x 1000	985-1010	985-1010	955-980/955-980	480-505	480-505	540	500	A22513	770,-
	800 x 800	785-810	785-810	755-780/755-780	237-262	237-262	350	550	A22518	748,-
	900 x 900	885-910	885-910	855-880/855-880	337-362	337-362	490	550	A22519	
	1000 x 1000	985-1010	985-1010	955-980/955-980	437-462	437-462	490	550	A22520	770,-

Made-to-measure

Height	Width B1/B2	Radius	Product no.	Base price
1900/2000	800-1250	500	A22580	879,-
	800-1250	550	A22581	

Adjustment range = dimensions - 15mm / + 10mm

Extras

Height	Extras	Profile	Product no.	Price
1900	Extension profile, 15mm for wall profile with 30,4mm		141001	32,-
2000			A21005	
	U-shaped enclosure stabilizer set connecting side panel with wall (1 set, 2 pcs. each)		C26001	111,-

Colours - Panel options

Profile colours	Colour code	Extra charges	Panel options		without Anti-Plaque		with Anti-Plaque	
			Glass code	Extra charges	Glass code	Extra charges		
White	055	0,-	Styrene Pacific S clear	264	0,-			
Matt silver	087		Clear	321		322	418,-	
			Privatima	373		375	789,-	

HÜPPE Alpha 2 partly framed Rectangular

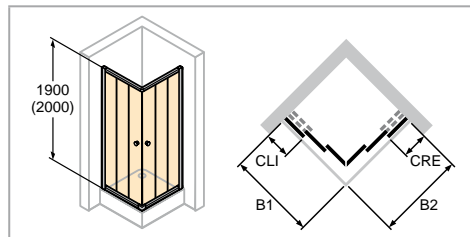
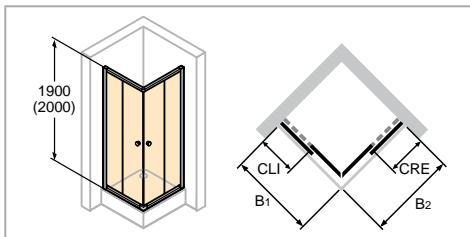

- Installation in U-shape possible, U-shape stabilizer set required.

Dimensions

WL: 30,4
R: 15
Mx: M+10
MG: 30

WEM = Tray installation dim. (000)
M = installation dimension Centre glass (001)
Please always specify when ordering.

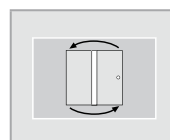
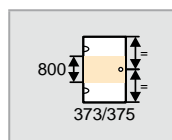
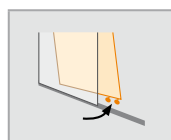
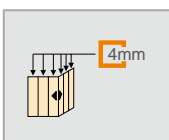
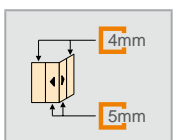

Sliding door, 2-section corner entry

Height	Model B1/B2	WEM B1	WEM B2	M (middle of glass)	CLI	CRE	Entry width	Product no.	Base price
1900	700x700	685-710	685-710	655-680/655-680	279-304	279-304	360	A20111	617,-
	750x750	735-760	735-760	705-730/705-730	304-329	304-329	403	A20101	
	800x800	785-810	785-810	755-780/755-780	329-354	329-354	432	A20102	
	900x900	885-910	885-910	855-880/855-880	379-404	379-404	503	A20103	
	1000x1000	985-1010	985-1010	955-980/955-980	429-454	429-454	573	A20104	636,-
		750x900 900x750	735-760 885-910	885-910 735-760	705-730/855-880 855-880/705-730	304-329 379-404	379-404 304-329	453	A20109
2000	700x700	685-710	685-710	655-680/655-680	279-304	279-304	360	A20112	682,-
	750x750	735-760	735-760	705-730/705-730	304-329	304-329	403	A20105	
	800x800	785-810	785-810	755-780/755-780	329-354	329-354	432	A20106	
	900x900	885-910	885-910	855-880/855-880	379-404	379-404	503	A20107	
	1000x1000	985-1010	985-1010	955-980/955-980	429-454	429-454	573	A20108	702,-
		750x900 900x750	735-760 885-910	885-910 735-760	705-730/855-880 855-880/705-730	304-329 379-404	379-404 304-329	453	A20113

Made-to-measure

Height	Width B1/B2	Product no.	Base price
1200-2000	600-1250	A20180	803,-

Adjustment range = dimensions - 15mm / + 10mm
NOTE: With dimensions < 700mm x 700mm entry width ~ 300mm.

Sliding door, 3-section corner entry



Height	Model B1/B2	WEM B1	WEM B2	M (middle of glass)	CLI	CRE	Entry width	Product no.	Base price
1900	700x700	685-710	685-710	655-680/655-680	241-266	241-266	413	A21108	710,-
	750x750	735-760	735-760	705-730/705-730	258-283	258-283	460	A21109	
	800x800	785-810	785-810	755-780/755-780	274-299	274-299	507	A21101	
	900x900	885-910	885-910	855-880/855-880	307-332	307-332	602	A21102	
	1000x1000	985-1010	985-1010	955-980/955-980	340-365	340-365	695	A21103	732,-
		750x900 900x750	735-760 885-910	885-910 735-760	705-730/855-880 855-880/705-730	257-282 307-332	307-332 257-282	535	A21107
2000	700x700	685-710	685-710	655-680/655-680	241-266	241-266	413	A21110	785,-
	750x750	735-760	735-760	705-730/705-730	258-283	258-283	460	A21111	
	800x800	785-810	785-810	755-780/755-780	274-299	274-299	507	A21104	
	900x900	885-910	885-910	855-880/855-880	307-332	307-332	602	A21105	
	1000x1000	985-1010	985-1010	955-980/955-980	340-365	340-365	695	A21106	809,-
		750x900 900x750	735-760 885-910	885-910 735-760	705-730/855-880 855-880/705-730	257-282 307-332	307-332 257-282	535	A21112

Made-to-measure

Height	Width B1/B2	Product no.	Base price
1200-2000	650-1250	A21180	924,-

Adjustment range = dimensions - 15mm / + 10mm

Extras

Height	Extras	Profile	Product no.	Price
1900	Extension profile, 15mm for wall profile with 30,4mm		141001	32,-
2000			A21005	
	U-shaped enclosure stabilizer set connecting side panel with wall (1 set, 2 pcs. each)		C26001	111,-

Colours - Panel options

Profile colours	Colour code	Extra charges	Panel options		without Anti-Plaque		with Anti-Plaque	
					Glass code	Extra charges	Glass code	Extra charges
White	055	0,-	Clear		321	0,-	322	418,-
Matt silver	087		Privatima		373	371,-	375	789,-

HÜPPE Alpha 2 partly framed Rectangular

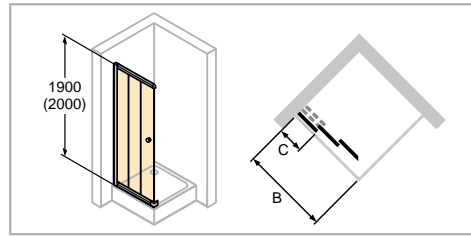
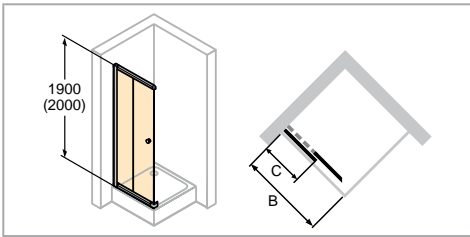

- Installation in U-shape possible, U-shape stabilizer set required.
- Sliding door, 2-section corner entry (1/2):**
- Combination not possible with corner entry sliding door, 3-panel (1/2).
- Sliding door, 3-section corner entry (1/2):**
- Combination not possible with corner entry sliding door, 2-panel (1/2).

	Dimensions
	WL: 30,4 R: 15 Mx: M+10 MG: 30
WEM = Tray installation dim. (000) M = installation dimension Centre glass (001) Please always specify when ordering.	

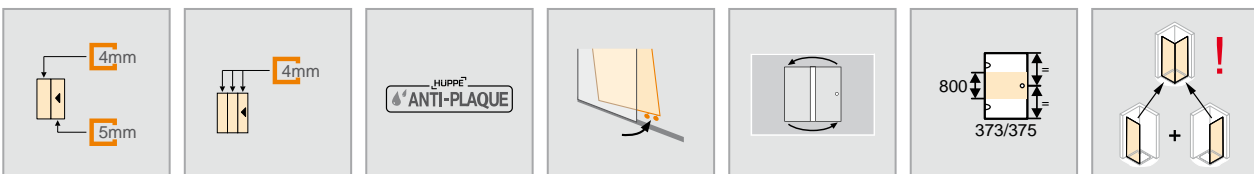

Sliding door, 2-section corner entry (1/2)

Height	Model	WEM B	M (middle of glass) B	C	Product no.	Base price
1900	700	685-710	655-680	279-304	A20201	364,-
	750	735-760	705-730	304-329	A20202	
	800	785-810	755-780	329-354	A20203	
	900	885-910	855-880	379-404	A20205	375,-
	1000	985-1010	955-980	429-454	A20207	
	1200	1185-1210	1155-1180	479-504	A20208	
2000	700	685-710	655-680	279-304	A20209	402,-
	750	735-760	705-730	304-329	A20210	
	800	785-810	755-780	329-354	A20211	
	900	885-910	855-880	379-404	A20212	415,-
	1000	985-1010	955-980	429-454	A20213	
	1200	1185-1210	1155-1180	479-504	A20214	

NOTE: The complete corner entry consists of two item nos.

Made-to-measure

Height	Width B	Product no.	Base price
1900-2000	600-1250	A20280	475,-

Adjustment range = dimensions - 15mm / + 10mm

Sliding door, 3-section corner entry (1/2)

Height	Model	WEM B	M (middle of glass) B	C	Product no.	Base price
1900	700	685-710	655-680	240-265	A21201	410,-
	750	735-760	705-730	257-282	A21202	
	800	785-810	755-780	274-299	A21203	
	900	885-910	855-880	307-332	A21204	422,-
	1000	985-1010	955-980	340-365	A21205	
2000	700	685-710	655-680	240-265	A21206	452,-
	750	735-760	705-730	257-282	A21207	
	800	785-810	755-780	274-299	A21208	
	900	885-910	855-880	307-332	A21209	466,-
	1000	985-1010	955-980	340-365	A21210	



NOTE: The complete corner entry consists of two item nos.

Made-to-measure

Height	Width B	Product no.	Base price
1900-2000	650-1250	A21280	534,-

Adjustment range = dimensions - 15mm / + 10mm

Extras

Height	Extras	Profile	Product	Price
1900	Extension profile, 15mm for wall profile with 30,4mm		141001	32,-
2000			A21005	
	U-shaped enclosure stabilizer set connecting side panel with wall (1 set, 2 pcs. each)		C26001	111,-

Colours - Panel options

Profile colours	Colour code	Extra charges	Panel options		without Anti-Plaque		with Anti-Plaque	
					Glass code	Extra charges	Glass code	Extra charges
White	055	0,-	Clear		321	0,-	322	209,-
Matt silver	087		Privatima		373	186,-	375	395,-

HÜPPE Alpha 2 partly framed Rectangular

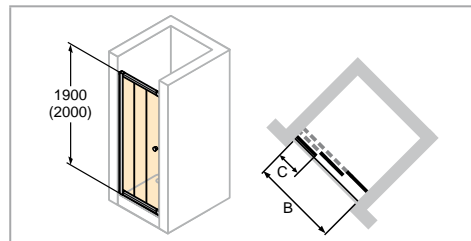
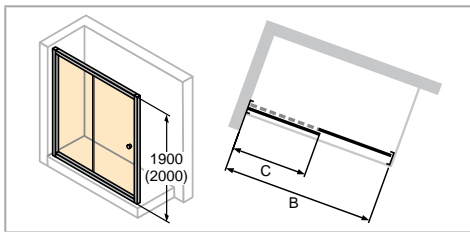

- Installation in U-shape possible, U-shape stabilizer set required.

Dimensions	
WL:	30,4
R:	5
Mx:	M+10
MG:	20

WEM = Tray installation dim. (000)
M = installation dimension Centre glass (001)
Please always specify when ordering.

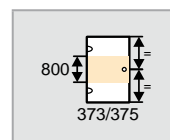
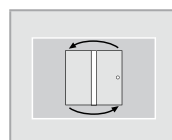
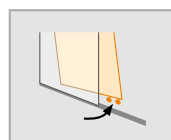
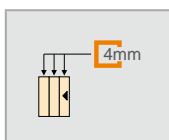
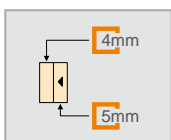

Sliding door, 1-panel with fixed segment

Height	Model	WEM In recess	WEM Side panel	M (middle of glass) Recess	M (middle of glass) Side panel	C	Entry width	Product no.	Base price
1900	1000	970-1020	985-1030	970-1020	965-1010	430-445	401	A20401	630,-
	1200	1170-1220	1185-1230	1170-1220	1165-1210	530-555	501	A20402	
	1300	1270-1320	1285-1330	1270-1320	1265-1310	580-605	551	A20403	
	1400	1370-1420	1385-1430	1370-1420	1365-1410	630-655	601	A20404	690,-
	1500	1470-1520	1485-1530	1470-1520	1465-1510	680-705	651	A20405	
	1600	1570-1620	1585-1630	1570-1620	1565-1610	780-805	651	A20406	787,-
	1700	1670-1720	1685-1730	1670-1720	1665-1710	880-905	651	A20407	
2000	1000	970-1020	985-1030	970-1020	965-1010	430-445	401	A20408	697,-
	1200	1170-1220	1185-1230	1170-1220	1165-1210	530-555	501	A20409	
	1300	1270-1320	1285-1330	1270-1320	1265-1310	580-605	551	A20410	
	1400	1370-1420	1385-1430	1370-1420	1365-1410	630-655	601	A20411	762,-
	1500	1470-1520	1485-1530	1470-1520	1465-1510	680-705	651	A20412	
	1600	1570-1620	1585-1630	1570-1620	1565-1610	780-805	651	A20413	869,-
	1700	1670-1720	1685-1730	1670-1720	1665-1710	880-905	651	A20414	

Made-to-measure

Height	Width B	Product no.	Base price
1200-2000	1000-1700	A20480	821,-

Adjustment range GTN = dimensions - 30mm / + 20mm
Adjustment range GTS = dimensions - 15mm / + 30mm

2-panel sliding door with fixed segment



Height	Model	WEM In recess	WEM Side panel	M (middle of glass) Recess	M (middle of glass) Side panel	C	Entry width	Product no.	Base price
1900	750	720-770	735-780	720-770	715-760	214-239	321	A20309	522,-
	780	750-800	765-810	750-800	745-790	266-291	341	A20313	538,-
	800	770-820	785-830	770-820	765-810	230-255	360	A20301	
	880	850-900	865-910	850-900	845-890	346-371	360	A20314	
	900	870-920	885-930	870-920	865-910	262-287	424	A20303	555,-
	980	950-1000	965-1010	950-1000	945-990	386-411	424	A20315	
	1000	970-1020	985-1030	970-1020	965-1010	295-320	490	A20305	
1200	1170-1220	1185-1230	1170-1220	1165-1210	362-387	621	A20310		
2000	750	720-770	735-780	720-770	715-760	214-239	321	A20311	577,-
	780	750-800	765-810	750-800	745-790	266-291	341	A20316	595,-
	800	770-820	785-830	770-820	765-810	230-255	360	A20306	
	880	850-900	865-910	850-900	845-890	346-371	360	A20317	
	900	870-920	885-930	870-920	865-910	262-287	424	A20307	613,-
	980	950-1000	965-1010	950-1000	945-990	386-411	424	A20318	
	1000	970-1020	985-1030	970-1020	965-1010	295-320	490	A20308	
1200	1170-1220	1185-1230	1170-1220	1165-1210	362-387	621	A20312		

Made-to-measure

Height	Width B	Product no.	Base price
1200-2000	750-1700	A20380	699,-

Adjustment range GTN = dimensions - 30mm / + 20mm
Adjustment range GTS = dimensions - 15mm / + 30mm

Extras

Height	Extras	Profile	Product no.	Price
1900	Extension profile, 15mm for wall profile with 30,4mm		141001	32,-
2000	Extension profile, 15mm for wall profile with 30,4mm		A21005	
	U-shaped enclosure stabilizer set connecting side panel with wall (1 set, 2 pcs. each)		C26001	111,-

Colours - Panel options

Profile colours	Colour code	Extra charges	Panel options		without Anti-Plaque		with Anti-Plaque	
			Glass code	Extra charges	Glass code	Extra charges		
White	055	0,-	Clear	321	0,-	322	209,-	
Matt silver	087		Privatima	373	186,-	375	395,-	

HÜPPE Alpha 2 partly framed Rectangular

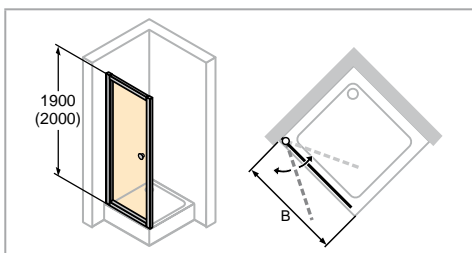

- Installation in U-shape possible, U-shape stabilizer set required.

	<p>Dimensions</p> <p>WL: 30,4 R: 5 Mx: M+10 MG: 20</p>
<p>WEM = Tray installation dim. (000) M = installation dimension Centre glass (001) Please always specify when ordering.</p>	

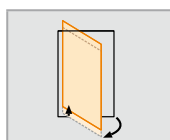
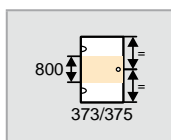
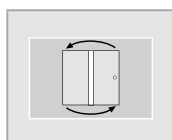
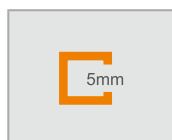



Swing door

Height	Model	WEM In recess	WEM Side panel	M (middle of glass) Recess	M (middle of glass) Side panel	Entry width	Product no.	Base price
1900	700	674-720	685-730	674-720	665-710	560	A25007	521,-
	750	724-770	735-780	724-770	715-760	610	A25008	
	780	754-800	765-810	754-800	745-790	640	A25011	538,-
	800	774-820	785-830	774-820	765-810	659	A25001	
	880	854-900	865-910	854-900	845-890	740	A25012	
	900	874-920	885-930	874-920	865-910	759	A25002	555,-
	980	954-1000	965-1010	954-1000	945-990	840	A25013	
1000	974-1020	985-1030	974-1020	965-1010	859	A25003		
2000	700	674-720	685-730	674-720	665-710	560	A25009	575,-
	750	724-770	735-780	724-770	715-760	610	A25010	
	780	754-800	765-810	754-800	745-790	640	A25014	595,-
	800	774-820	785-830	774-820	765-810	659	A25004	
	880	854-900	865-910	854-900	845-890	740	A25015	
	900	874-920	885-930	874-920	865-910	759	A25005	613,-
	980	954-1000	965-1010	954-1000	945-990	840	A25016	
1000	974-1020	985-1030	974-1020	965-1010	859	A25006		

Made-to-measure

Height	Width B	Product no.	Base price
1200-2000	600-1000	A25080	699,-
Adjustment range STN = dimensions - 26mm / + 20mm			
Adjustment range STS = dimensions - 15mm / + 30mm			

Extras

Height	Extras	Profile	Product no.	Price
1900	Extension profile, 15mm for wall profile with 30,4mm		141001	32,-
2000			A21005	
	U-shaped enclosure stabilizer set connecting side panel with wall (1 set, 2 pcs. each)		C26001	111,-

Colours - Panel options

Profile colours	Colour code	Extra charges	Panel options		without Anti-Plaque		with Anti-Plaque	
			Glass code	Extra charges	Glass code	Extra charges		
White	055	0,-	Clear	321	0,-	322	209,-	
Matt silver	087		Privatima	373	186,-	375	395,-	

HÜPPE Alpha 2 partly framed Rectangular

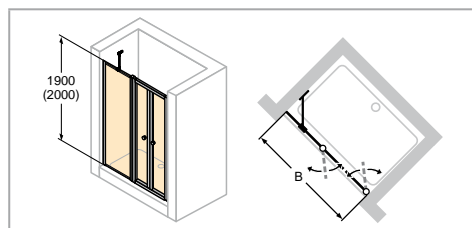
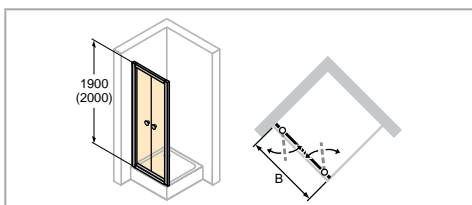

- Installation in U-shape possible, U-shape stabilizer set required.

Dimensions

WL: 30,4
R: 5
Mx: M+10
MG: 20

WEM = Tray installation dim. (000)
M = installation dimension Centre glass (001)
Please always specify when ordering.

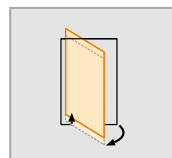
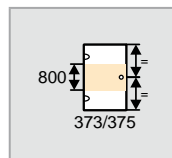
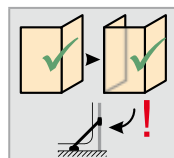
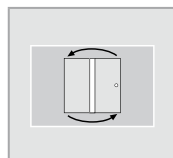
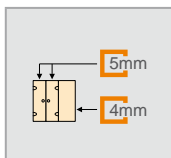
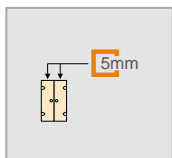

Two-way door

Height	Model	WEM In recess	WEM Side panel	M (middle of glass) Recess	M (middle of glass) Side panel	Entry width	Product no.	Base price	
1900	700	674-720	685-730	674-720	665-710	532	A25101	538,-	
	750	724-770	735-780	724-770	705-750	582	A25102		
	780	754-800	765-810	754-800	745-790	640	A25113		
	800	774-820	785-830	774-820	765-810	632	A25103		
	880	854-900	865-910	854-900	845-890	710	A25114		
	900	874-920	885-930	874-920	865-910	732	A25104		
	980	954-1000	965-1010	954-1000	945-990	810	A25115	555,-	
	1000	974-1020	985-1030	974-1020	965-1010	832	A25105	566,-	
2000	1200	1174-1220	1185-1230	1174-1220	1165-1210	1032	A25106	595,-	
	700	674-720	685-730	674-720	665-710	532	A25107		
	750	724-770	735-780	724-770	705-750	582	A25108		
	780	754-800	765-810	754-800	745-790	640	A25116		
	800	774-820	785-830	774-820	765-810	632	A25109		
	880	854-900	865-910	854-900	845-890	710	A25117		
	900	874-920	885-930	874-920	865-910	732	A25110		
	980	954-1000	965-1010	954-1000	945-990	810	A25118		
	1000	974-1020	985-1030	974-1020	965-1010	832	A25111		613,-
	1200	1174-1220	1185-1230	1174-1220	1165-1210	1032	A25112		624,-

Made-to-measure

Height	Width B	Product no.	Base price
1200-2000	600-1200	A25180	772,-
Adjustment range STN = dimensions - 26mm / + 20mm			
Adjustment range PTS = dimensions - 15mm / + 30mm			



Two-way door with additional section

Height	Model	WEM In recess	WEM Side panel	M (middle of glass) Recess	M (middle of glass) Side panel	Entry width	Product no.	Base price
1900	1200	1144-1240	1155-1250	1144-1240	1135-1230	620	A25201	796,-
	1300	1244-1340	1255-1350	1244-1340	1235-1330	620	A25202	
	1400	1344-1440	1355-1450	1344-1440	1335-1430	620	A25203	
	1500	1444-1540	1455-1550	1444-1540	1435-1530	720	A25204	812,-
	1600	1544-1640	1555-1650	1544-1640	1535-1630	820	A25205	
	1700	1644-1740	1655-1750	1644-1740	1635-1730	1020	A25206	828,-
	1800	1744-1840	1755-1850	1744-1840	1735-1830	1020	A25207	
2000	1200	1144-1240	1155-1250	1144-1240	1135-1230	620	A25208	796,-
	1300	1244-1340	1255-1350	1244-1340	1235-1330	620	A25209	879,-
	1400	1344-1440	1355-1450	1344-1440	1335-1430	620	A25210	
	1500	1444-1540	1455-1550	1444-1540	1435-1530	720	A25211	898,-
	1600	1544-1640	1555-1650	1544-1640	1535-1630	820	A25212	
	1700	1644-1740	1655-1750	1644-1740	1635-1730	1020	A25213	915,-
	1800	1744-1840	1755-1850	1744-1840	1735-1830	1020	A25214	

Made-to-measure

Height	Width B	Product no.	Base price
1200-2000	1000-2000	A25280	1.027,-
Adjustment range STN = dimensions - 26mm / + 20mm			
Adjustment range PTS = dimensions - 7mm / + 18mm			
The width of the additional section must be stated.			

Extras

Height	Extras	Profile	Product no.	Price
1900	Extension profile, 15mm for wall profile with 30,4mm		141001	32,-
2000			A21005	
	U-shaped enclosure stabilizer set connecting side panel with wall (1 set, 2 pcs. each)		C26001	111,-

Colours - Panel options

Profile colours	Colour code	Extra charges	Panel options		without Anti-Plaque		with Anti-Plaque	
					Glass code	Extra charges	Glass code	Extra charges
White	055	0,-	Clear		321	0,-	322	209,-
Matt silver	087		Privatima		373	186,-	375	395,-

HÜPPE Alpha 2 partly framed Rectangular

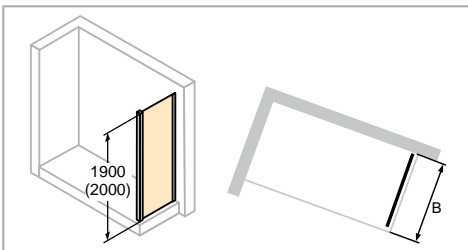

- Cannot be ordered as a free-standing side panel.
- Wall profile width of side panel on bathtub: 20mm.

Dimensions

WL:	30,4	20
R:	5	5
Mx:	M+10	M+10
MG:	20	20

WEM = Tray installation dim. (000)
M = installation dimension Centre glass (001)
Please always specify when ordering.

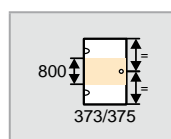
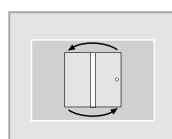
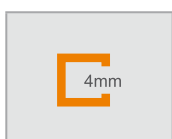

Side panel

Height	Model	WEM B	M (middle of glass) B	Product no.	Base price
1900	SW 700	685-710	665-690	A20501	315,-
	SW 750	735-760	715-740	A20502	
	SW 780	765-790	745-770	A20515	
	SW 800	785-810	765-790	A20503	
	SW 880	865-890	845-870	A20516	324,-
	SW 900	885-910	865-890	A20505	
	SW 980	965-990	945-970	A20517	
	SW 1000	985-1010	965-990	A20507	
2000	SW 1200	1185-1210	1165-1190	A20514	349,-
	SW 700	685-710	665-690	A20508	358,-
	SW 750	735-760	715-740	A20509	
	SW 780	765-790	745-770	A20518	
	SW 800	785-810	765-790	A20510	
	SW 880	865-890	845-870	A20519	367,-
	SW 900	885-910	865-890	A20511	
	SW 980	965-990	945-970	A20520	
	SW 1000	985-1010	965-990	A20512	
	SW 1200	1185-1210	1165-1190	A20521	385,-

Made-to-measure

Height	Model	Width B	Product no.	Base price
500-2000	Standard made-to-measure	200-1200	A20580	421,-
	In-line configuration	200-1200	A20581	
	On bathtub	200-1200	A20582	

Adjustment range = dimensions - 15mm / + 10mm

Slopes and cut-outs

Slopes and cut-outs	Extra charges
 Supplement per slope/cut-out for made-to-measure	170,-

Colours - Panel options

Profile colours	Colour code	Extra charges	Panel options	without Anti-Plaque		with Anti-Plaque	
				Glass code	Extra charges	Glass code	Extra charges
White	055	0,-	Clear	321	0,-	322	209,-
Matt silver	087		Privatima	373	186,-	375	395,-

HÜPPE Alpha 2 partly framed Quadrant

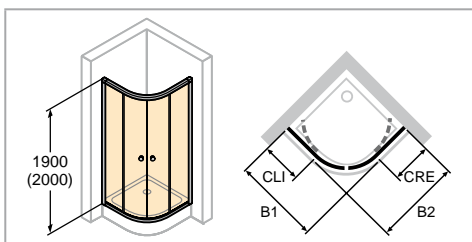

- Installation in U-shape possible, U-shape stabilizer set required.

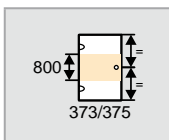
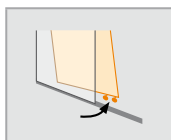
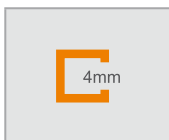
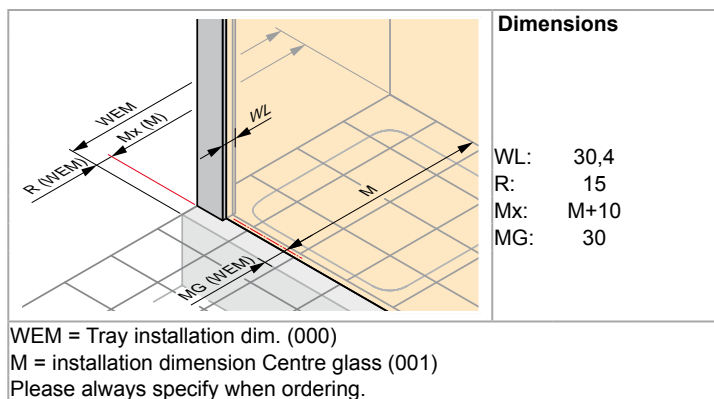

Sliding door



Height	Model B1/B2	WEM B1	WEM B2	M (middle of glass) B1/B2	CLI	CRE	Entry width	Radius	Product no.	Base price
1900	800 x 800	785-810	785-810	755-780/755-780	286-311	286-311	490	500	A20601	710,-
	900 x 900	885-910	885-910	855-880/855-880	340-365	340-365	570	500	A20602	
	1000 x 1000	985-1010	985-1010	955-980/955-980	440-465	440-465	570	500	A20605	732,-
	800 x 800	785-810	785-810	755-780/755-780	230-255	230-255	400	550	A20603	710,-
	900 x 900	885-910	885-910	855-880/855-880	330-355	330-355	584	550	A20604	
	1000 x 1000	985-1010	985-1010	955-980/955-980	430-455	430-455	584	550	A20606	732,-
2000	800 x 800	785-810	785-810	755-780/755-780	286-311	286-311	490	500	A20611	785,-
	900 x 900	885-910	885-910	855-880/855-880	340-365	340-365	570	500	A20612	
	1000 x 1000	985-1010	985-1010	955-980/955-980	440-465	440-465	570	500	A20613	809,-
	800 x 800	785-810	785-810	755-780/755-780	230-255	230-255	400	550	A20618	785,-
	900 x 900	885-910	885-910	855-880/855-880	330-355	330-355	584	550	A20619	
	1000 x 1000	985-1010	985-1010	955-980/955-980	430-455	430-455	584	550	A20620	809,-

Made-to-measure

Height	Width B1/B2	Radius	Product no.	Base price
1900/2000	800-1250	500	A20680	924,-
	800-1250	550	A20681	

Adjustment range = dimensions - 15mm / + 10mm

Extras

Height	Extras	Profile	Product no.	Price
1900	Extension profile, 15mm for wall profile with 30,4mm		141001	32,-
2000			A21005	
	U-shaped enclosure stabilizer set connecting side panel with wall (1 set, 2 pcs. each)		C26001	111,-

Colours - Panel options

Profile colours	Colour code	Extra charges	Panel options		without Anti-Plaque		with Anti-Plaque	
					Glass code	Extra charges	Glass code	Extra charges
White	055	0,-	Clear		321	0,-	322	418,-
Matt silver	087		Privatima		373	371,-	375	789,-

HÜPPE Classics 2 model overview - Base price

Rectangular

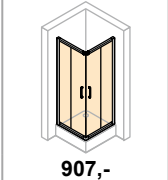
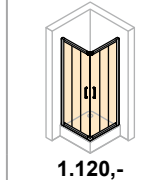
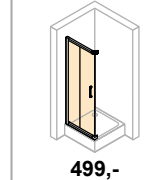
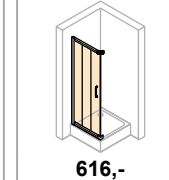
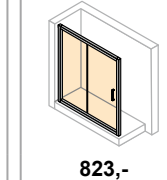
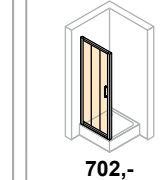
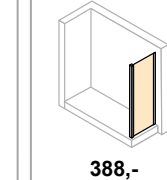
Sliding door, 2-section corner entry	Sliding door, 3-section corner entry	Sliding door, 2-section corner entry (1/2)	Sliding door, 3-section corner entry (1/2)	Sliding door, 1-panel with fixed segment	2-panel sliding door with fixed segment	Side panel for sliding door
						
907,-	1.120,-	499,-	616,-	823,-	702,-	388,-
E.6-E.7	E.6-E.7	E.8-E.9	E.8-E.9	E.10-E.11	E.12-E.13	E.14-E.15

Quadrant

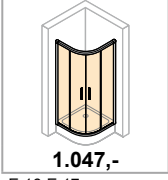
Sliding door

1.047,-
E.16-E.17

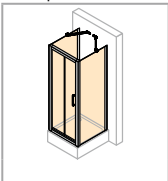
U-shaped enclosure

Sliding door as U-shaped enclosure

E.28-E.29

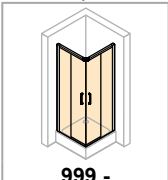
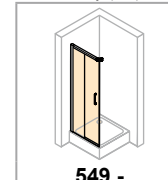
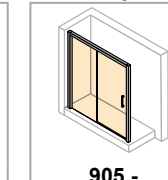
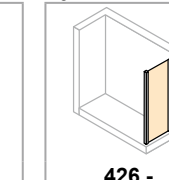
EasyEntry

Rectangular

Sliding door, 2-section corner entry	Sliding door, 2-section corner entry (1/2)	Sliding door, 1-panel with fixed segment	Side panel for sliding door
			
999,-	549,-	905,-	426,-
E.18-E.19	E.20-E.21	E.22-E.23	E.24-E.25

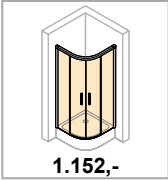
Quadrant

Sliding door

1.152,-
E.26-E.27

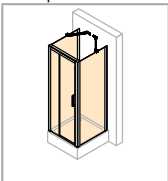
U-shaped enclosure

Sliding door as U-shaped enclosure

E.28-E.29

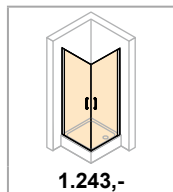
Rectangular

Swing door corner entry



1.243,-

E.32-E.33

Swing door for side panel/Corner entry

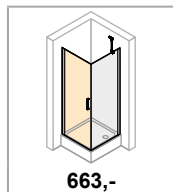

663,-

E.34-E.35

Swing door in recess

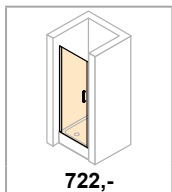

722,-

E.36-E.37

Swing door corner entry with fixed segments

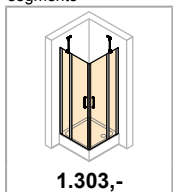

1.303,-

E.38-E.39

Swing door with fixed segment for side panel/corner entry

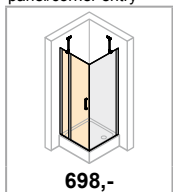

698,-

E.40-E.41

Swing door with fixed segment in recess

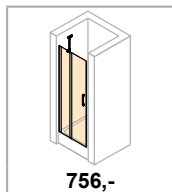

756,-

E.42-E.43

Side panel for swing door

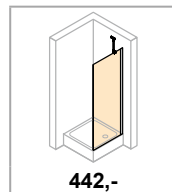

442,-

E.44-E.45

Swing door with additional section in recess

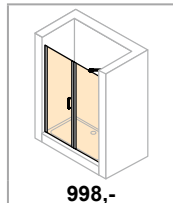

998,-

E.46-E.47

Two-way door in recess

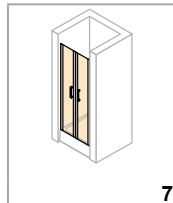

756,-

E.48-E.49

Two-way door for side panel

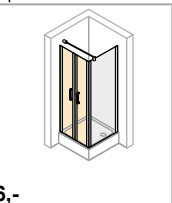

E.48-E.49

Side panel for two-way door

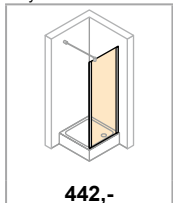

442,-

E.50-E.51

Two-way with additional section in recess

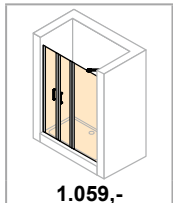

1.059,-

E.52-E.53

Quadrant

Swing door with fixed segments, 2-panel (1/2)

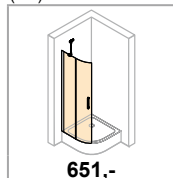

651,-

E.54-E.55

U-shaped enclosure

Swing door, rectangular U-shaped enclosure

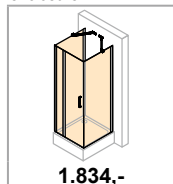

1.834,-

E.56

HÜPPE Classics 2 sliding doors

HÜPPE Classics 2 EasyEntry sliding doors



HÜPPE Classics 2 swing doors



Product details

Sliding doors



Handle



High quality corner connector



Easy installation technology due to the HÜPPE sealing system

- Patented, very simple installation using proven method
- No exposed screws in the vicinity of the wall profile

Handle and corner connectors always in silver high-gloss, except with the Black Edition.



HÜPPE Classics 2 sliding doors:
Removable door segments for easy cleaning
with all sliding door models



High quality double rollers for smooth
opening and closing of the sliding doors



HÜPPE Classics 2 EasyEntry sliding doors:
Removable door segments for easy cleaning
with all sliding door models

All models in the HÜPPE Classics 2 EasyEntry sliding doors can be optionally installed with a drip deflector strip for optimum tightness or as easy access units.

Product details

Swing doors



Handle



Stabilizer



Tubular hinge

Handle, stabilizer, cross-bracing and drip deflector strip always in high-gloss silver



The powerful rise & fall mechanism lifts the doors by 5mm on opening so that the sealing profiles do not scrape over the floor



All models of the HÜPPE Classics 2 sliding doors can be optionally installed with a drip deflector strip for optimum tightness or as easy access units

HÜPPE Classics 2 Rectangular

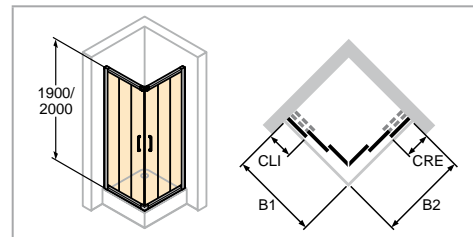
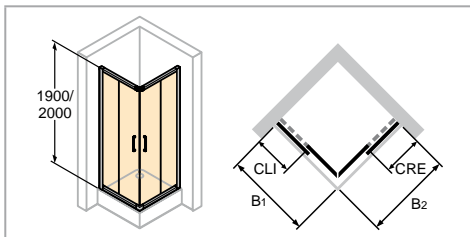

- Installation in U-shape possible, U-shape stabilizer set required.

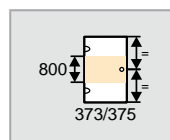
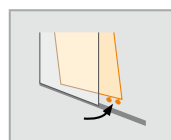
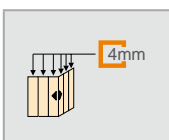
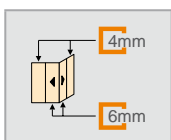
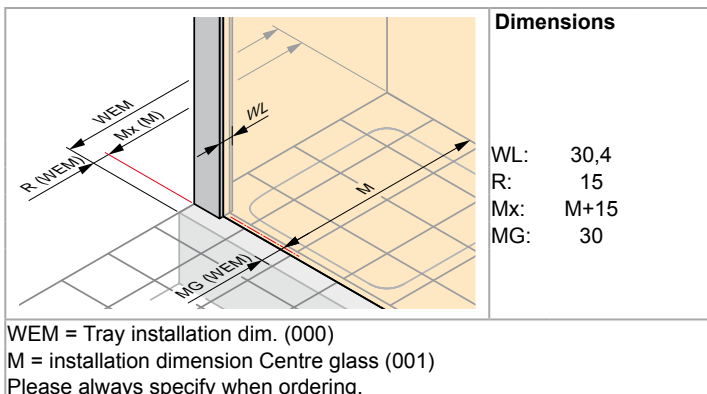

Sliding door, 2-section corner entry

Height	Model B1/B2	WEM B1/B2	M (middle of glass) B1/B2	CLI	CRE	Entry width	Product no.	Base price
1900	750x750	735-760	705-730	304-329	304-329	403	C20101	907,-
	800x800	785-810	755-780	329-354	329-354	432	C20102	
	900x900	885-910	855-880	379-404	379-404	503	C20103	
	1000x1000	985-1010	955-980	429-454	429-454	573	C20104	
2000	750x750	735-760	705-730	304-329	304-329	403	C20105	999,-
	800x800	785-810	755-780	329-354	329-354	432	C20106	
	900x900	885-910	855-880	379-404	379-404	503	C20107	
	1000x1000	985-1010	955-980	429-454	429-454	573	C20108	

Made-to-measure

Height	Width B1/B2	Product no.	Base price
1200-2000	700-1250	C20180	1.179,-

Adjustment range = dimensions - 15mm / + 10mm

Sliding door, 3-section corner entry



Height	Model B1/B2	WEM B1/B2	M (middle of glass) B1/B2	CLI	CRE	Entry width	Product no.	Base price
1900	800x800	785-810	755-780	274-299	274-299	507	C21101	1.120,-
	900x900	885-910	855-880	307-332	307-332	602	C21102	
	1000x1000	985-1010	955-980	340-365	340-365	695	C21103	
2000	800x800	785-810	755-780	274-299	274-299	507	C21104	1.232,-
	900x900	885-910	855-880	307-332	307-332	602	C21105	
	1000x1000	985-1010	955-980	340-365	340-365	695	C21106	

Made-to-measure

Height	Width B1/B2	Product no.	Base price
1200-2000	700-1250	C21180	1.457,-

Adjustment range = dimensions - 15mm / + 10mm

Extras

Height	Description	Profile	Product no.	Price
1900	Extension profile, 15mm for wall profile with 30,4mm		141001	32,-
2000			A21005	
	U-shaped enclosure stabilizer set connecting side panel with wall (1 set, 2 pcs. each)		C26001	111,-

Colours - Panel options

Profile colours	Colour code	Extra charges	Panel options		without Anti-Plaque		with Anti-Plaque	
			Glass code	Extra charges	Glass code	Extra charges	Glass code	Extra charges
White	055	0,-	Clear	321	0,-	322	418,-	
Silver high-gloss	069		Privatima	373	371,-	375	789,-	
Matt silver	087							

HÜPPE Classics 2 Rectangular

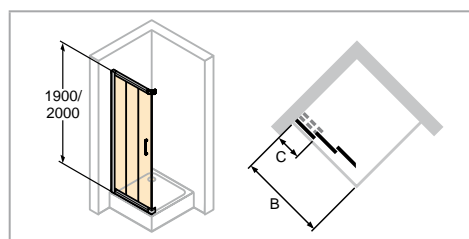
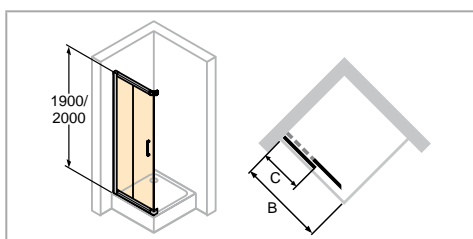

• Installation in U-shape possible, U-shape stabilizer set required.

Sliding door, 2-section corner entry (1/2):

• Combination not possible with corner entry sliding door, 3-panel (1/2).

Sliding door, 3-section corner entry (1/2):

• Combination not possible with corner entry sliding door, 2-panel (1/2).

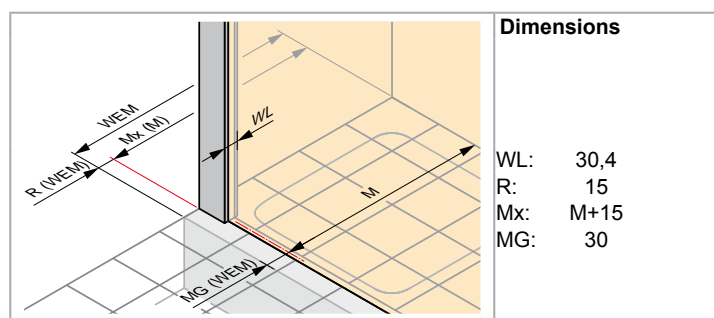

WEM = Tray installation dim. (000)

M = installation dimension Centre glass (001)

Please always specify when ordering.

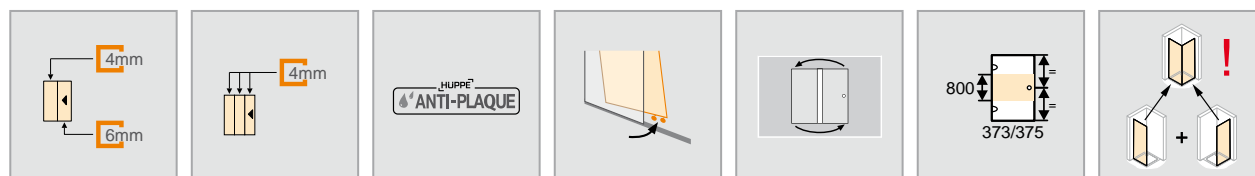

Sliding door, 2-section corner entry (1/2)

Height	Model	WEM B	M (middle of glass) B	Width C	Product no.	Base price
1900	700	685-710	655-680	279-304	C20201	499,-
	750	735-760	705-730	304-329	C20202	
	800	785-810	755-780	329-354	C20203	
	850	835-860	805-830	379-404	C20215	
	900	885-910	855-880	379-404	C20205	
	950	935-960	905-930	429-454	C20216	514,-
	1000	985-1010	955-980	429-454	C20207	
	1050	1035-1060	1005-1030	479-504	C20217	
	1100	1085-1110	1055-1080	529-554	C20218	
	1150	1135-1160	1105-1130	579-604	C20219	530,-
1200	1185-1210	1155-1180	479-504	C20208		
2000	700	685-710	655-680	279-304	C20209	549,-
	750	735-760	705-730	304-329	C20210	
	800	785-810	755-780	329-354	C20211	
	850	835-860	805-830	379-404	C20220	
	900	885-910	855-880	379-404	C20212	
	950	935-960	905-930	429-454	C20221	566,-
	1000	985-1010	955-980	429-454	C20213	
	1050	1035-1060	1005-1030	479-504	C20222	
	1100	1085-1110	1055-1080	529-554	C20223	
	1150	1135-1160	1105-1130	579-604	C20224	581,-
1200	1185-1210	1155-1180	479-504	C20214		

NOTE: The complete corner entry consists of two item nos.

Asymmetric combinations possible

Made-to-measure

Height	Width B	Product no.	Base price
1200-2000	700-1250	C20280	649,-

Adjustment range = dimensions - 15mm / + 10mm

Sliding door, 3-section corner entry (1/2)

Height	Model	WEM B	M (middle of glass) B	Width C	Product no.	Base price
1900	700	685-710	655-680	240-265	C21201	616,-
	750	735-760	705-730	257-282	C21202	
	800	785-810	755-780	274-299	C21203	
	900	885-910	855-880	307-332	C21204	634,-
	1000	985-1010	955-980	340-365	C21205	
2000	700	685-710	655-680	240-265	C21206	678,-
	750	735-760	705-730	257-282	C21207	
	800	785-810	755-780	274-299	C21208	
	900	885-910	855-880	307-332	C21209	698,-
	1000	985-1010	955-980	340-365	C21210	

NOTE: The complete corner entry consists of two item nos.



Asymmetric combinations possible

Made-to-measure

Height	Width B	Product no.	Base price
1200-2000	700-1250	C21280	802,-

Adjustment range = dimensions - 15mm / + 10mm

Extras

Height	Profile	Product no.	Price
1900	 Extension profile, 15mm for wall profile with 30,4mm	141001	32,-
2000		A21005	
	 U-shaped enclosure stabilizer set connecting side panel with wall (1 set, 2 pcs. each)	C26001	111,-

Colours - Panel options

Profile colours	Colour code	Extra charges	Panel options		without Anti-Plaque		with Anti-Plaque	
			Glass code	Extra charges	Glass code	Extra charges		
White	055	0,-	Clear	321	0,-	322	209,-	
Silver high-gloss	069		Privatima	373	186,-	375	395,-	
Matt silver	087							

HÜPPE Classics 2 Rectangular

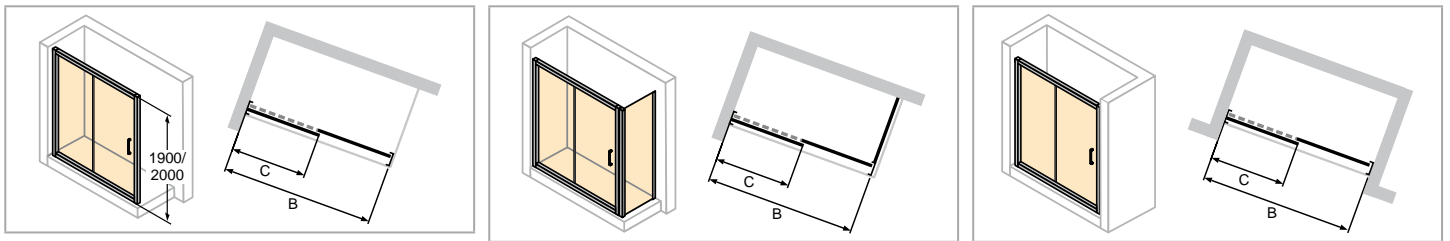

- Installation in U-shape possible, U-shape stabilizer set required.
- NOTE: Installation scenario door in recess, door for side panel or installation in U-shape must be specified in the text for made-to-measure orders.

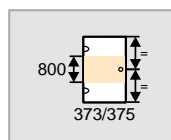
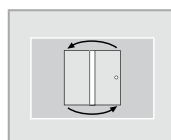
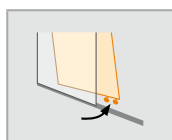
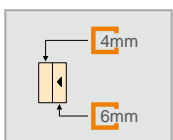
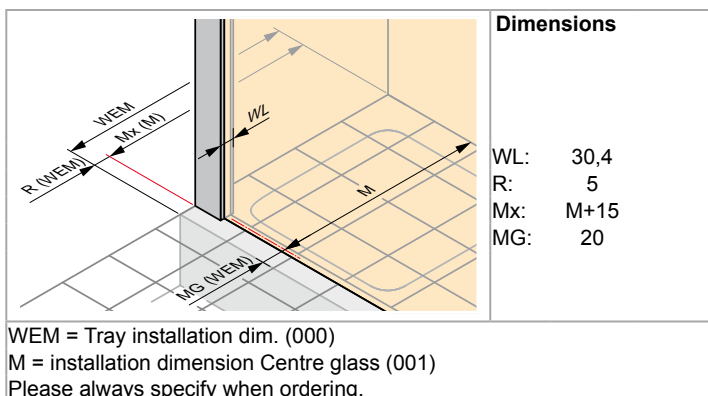

Sliding door, 1-panel with fixed segment

Height	Model	WEM In recess	WEM Side panel	M (middle of glass) Recess	M (middle of glass) Side panel	Width C	Entry width	Product no.	Base price
1900	1000	970-1020	985-1030	970-1020	965-1010	430-455	401	C20401	823,-
	1200	1170-1220	1185-1230	1170-1220	1165-1210	530-555	501	C20402	848,-
	1250	1220-1270	1235-1280	1220-1270	1215-1260	580-605	501	C20415	
	1300	1270-1320	1285-1330	1270-1320	1265-1310	580-605	551	C20403	
	1350	1320-1370	1335-1380	1320-1370	1315-1360	630-655	551	C20416	
	1400	1370-1420	1385-1430	1370-1420	1365-1410	630-655	601	C20404	
	1450	1420-1470	1435-1480	1420-1470	1415-1460	680-705	601	C20417	
	1500	1470-1520	1485-1530	1470-1520	1465-1510	680-705	651	C20405	
	1550	1520-1570	1535-1580	1520-1570	1515-1560	780-805	651	C20418	
	1600	1570-1620	1585-1630	1570-1620	1565-1610	780-805	651	C20406	
1650	1620-1670	1635-1680	1620-1670	1615-1660	830-855	651	C20419		
1700	1670-1720	1685-1730	1670-1720	1665-1710	880-905	651	C20407		
2000	1000	970-1020	985-1030	970-1020	965-1010	430-455	401	C20408	905,-
	1200	1170-1220	1185-1230	1170-1220	1165-1210	530-555	501	C20409	933,-
	1250	1220-1270	1235-1280	1220-1270	1215-1260	580-605	501	C20420	
	1300	1270-1320	1285-1330	1270-1320	1265-1310	580-605	551	C20410	
	1350	1320-1370	1335-1380	1320-1370	1315-1360	630-655	551	C20421	
	1400	1370-1420	1385-1430	1370-1420	1365-1410	630-655	601	C20411	
	1450	1420-1470	1435-1480	1420-1470	1415-1460	680-705	601	C20422	
	1500	1470-1520	1485-1530	1470-1520	1465-1510	680-705	651	C20412	
	1550	1520-1570	1535-1580	1520-1570	1515-1560	780-805	651	C20423	
	1600	1570-1620	1585-1630	1570-1620	1565-1610	780-805	651	C20413	
1650	1620-1670	1635-1680	1620-1670	1615-1660	830-855	651	C20424		
1700	1670-1720	1685-1730	1670-1720	1665-1710	880-905	651	C20414		



Made-to-measure

Height	Width B	Product no.	Base price
1200-2000	1000-1700	C20480	1.069,-

Adjustment range GTN = dimensions - 30mm / + 20mm

Adjustment range GTS = dimensions - 15mm / + 30mm

Extras

Height	Profile	Product no.	Price
1900		141001	32,-
2000		A21005	
		C26001	111,-

Colours - Panel options

Profile colours	Colour code	Extra charges	Panel options		without Anti-Plaque		with Anti-Plaque	
			Glass code	Extra charges	Glass code	Extra charges		
White	055	0,-	Clear	321	0,-	322	209,-	
Silver high-gloss	069		Privatima	373	186,-	375	395,-	
Matt silver	087							

HÜPPE Classics 2 Rectangular

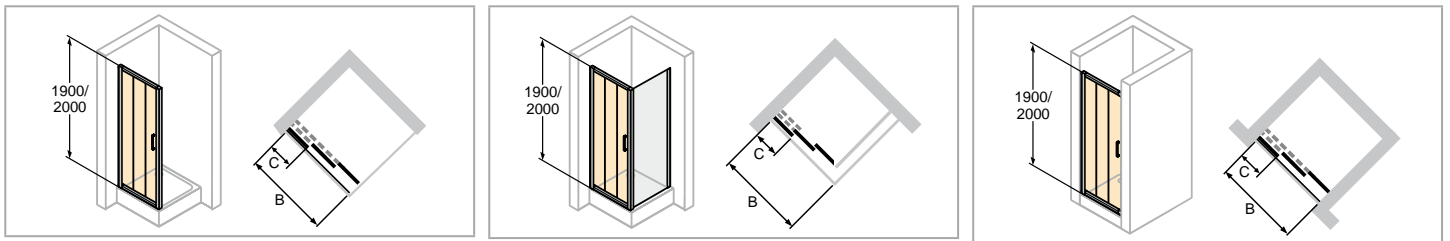

- Installation in U-shape possible, U-shape stabilizer set required.
- NOTE: Installation scenario door in recess, door for side panel or installation in U-shape must be specified in the text for made-to-measure orders.

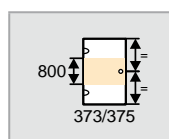
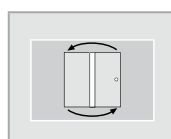
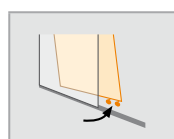
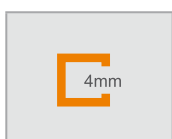
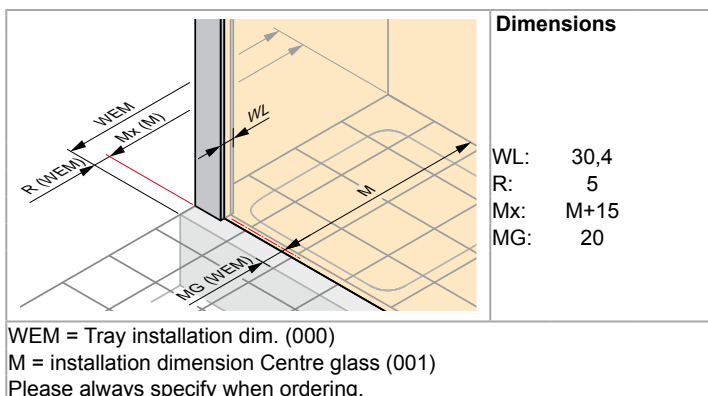



2-panel sliding door with fixed segment

Height	Model	WEM In recess	WEM Side panel	M (middle of glass) Recess	M (middle of glass) Side panel	Width C	Entry width	Product no.	Base price
1900	750	720-770	735-780	720-770	715-760	214-239	321	C20309	702,-
	800	770-820	785-830	770-820	765-810	230-255	360	C20301	724,-
	900	870-920	885-930	870-920	865-910	262-287	424	C20303	
	1000	970-1020	985-1030	970-1020	965-1010	295-320	490	C20305	746,-
	1200	1170-1220	1185-1230	1170-1220	1165-1210	362-387	621	C20310	766,-
2000	750	720-770	735-780	720-770	715-760	214-239	321	C20311	772,-
	800	770-820	785-830	770-820	765-810	230-255	360	C20306	795,-
	900	870-920	885-930	870-920	865-910	262-287	424	C20307	
	1000	970-1020	985-1030	970-1020	965-1010	295-320	490	C20308	820,-
	1200	1170-1220	1185-1230	1170-1220	1165-1210	362-387	621	C20312	843,-

Made-to-measure

Height	Width B	Product no.	Base price
1200-2000	750-1700	C20380	940,-
Adjustment range GTN = dimensions - 30mm / + 20mm			
Adjustment range GTS = dimensions - 15mm / + 30mm			

Extras

Height	Profile	Product no.	Price
1900		141001	32,-
2000		A21005	
		C26001	111,-

Colours - Panel options

Profile colours	Colour code	Extra charges	Panel options		without Anti-Plaque		with Anti-Plaque	
			Glass code	Extra charges	Glass code	Extra charges		
White	055	0,-	Clear	321	0,-	322	209,-	
Silver high-gloss	069		Privatima	373	186,-	375	395,-	
Matt silver	087							

HÜPPE Classics 2 Rectangular

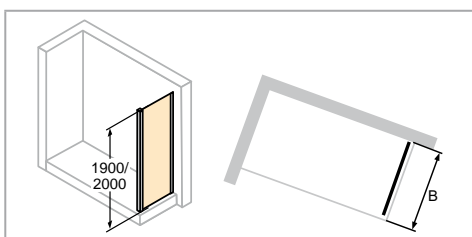

- Cannot be ordered as a free-standing side panel.

Dimensions

WL:	30,4	20
R:	5	5
Mx:	M+15	M+15
MG:	20	20

WEM = Tray installation dim. (000)
M = installation dimension Centre glass (001)
Please always specify when ordering.

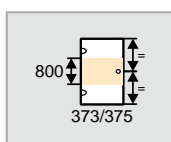
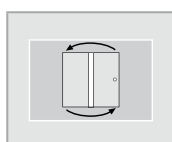
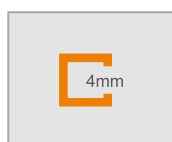

Side panel for sliding door

Height	Model	WEM B	M (middle of glass) B	Product no.	Base price
1900	SW 700	685-710	665-690	C20501	388,-
	SW 750	735-760	715-740	C20502	
	SW 800	785-810	765-790	C20503	
	SW 900	885-910	865-890	C20505	400,-
	SW 1000	985-1010	965-990	C20507	
2000	SW 700	685-710	665-690	C20508	426,-
	SW 750	735-760	715-740	C20509	
	SW 800	785-810	765-790	C20510	
	SW 900	885-910	865-890	C20511	440,-
	SW 1000	985-1010	965-990	C20512	

Made-to-measure

Height	Model	Width B	Product no.	Base price
500-2000	Standard made-to-measure	200-1200	C20580	504,-
	In-line configuration	200-1200	C20581	
	On bathtub	200-1200	C20582	

Adjustment range = dimensions - 15mm / + 10mm

Slopes and cut-outs

Slopes and cut-outs	Extra charges
 Supplement per slope/cut-out for made-to-measure	170,-

Extras

Height	Profile	Product no.	Price
1900		141001	32,-
2000		A21005	

Colours - Panel options

Profile colours	Colour code	Extra charges	Panel options		without Anti-Plaque		with Anti-Plaque	
			Glass code	Extra charges	Glass code	Extra charges		
White	055	0,-	Clear	321	0,-	322	209,-	
Silver high-gloss	069		Privatima	373	186,-	375	395,-	
Matt silver	087							

HÜPPE Classics 2 Quadrant

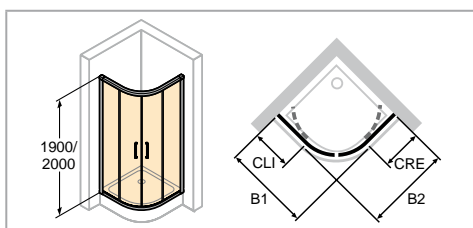

- Installation in U-shape possible, U-shape stabilizer set required.

Dimensions	
	WL: 30,4 R: 15 Mx: M+15 MG: 30
WEM = Tray installation dim. (000) M = installation dimension Centre glass (001) Please always specify when ordering.	

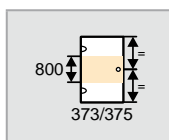
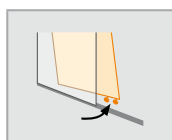
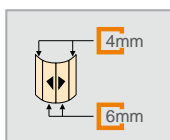

Sliding door



Height	Model B1/B2	WEM B1	WEM B2	M (middle of glass) B1	M (middle of glass) B2	CLI	CRE	Entry width	Radius	Product no.	Base price
1900	800 x 800	785-810	785-810	755-780	755-780	286-311	286-311	490	500	C20601	1.047,-
	900 x 900	885-910	885-910	855-880	855-880	340-365	340-365	570	500	C20602	
	1000 x 1000	985-1010	985-1010	955-980	955-980	440-465	440-465	570	500	C20605	
	800 x 900	785-810	885-910	755-780	855-880	286-311	386-411	490	500	C20607	
	900 x 800	885-910	785-810	855-880	755-780	386-411	286-311	490	500	C20608	
	800 x 1000	785-810	985-1010	755-780	955-980	286-311	486-511	490	500	C20609	
	1000 x 800	985-1010	785-810	955-980	755-780	486-511	286-311	490	500	C20610	
	800 x 800	785-810	785-810	755-780	755-780	230-255	230-255	400	550	C20603	
	900 x 900	885-910	885-910	855-880	855-880	330-355	330-355	584	550	C20604	
	1000 x 1000	985-1010	985-1010	955-980	955-980	430-455	430-455	584	550	C20606	
2000	800 x 800	785-810	785-810	755-780	755-780	286-311	286-311	490	500	C20611	1.152,-
	900 x 900	885-910	885-910	855-880	855-880	340-365	340-365	570	500	C20612	
	1000 x 1000	985-1010	985-1010	955-980	955-980	440-465	440-465	570	500	C20613	
	800 x 900	785-810	885-910	755-780	855-880	286-311	386-411	490	500	C20614	
	900 x 800	885-910	785-810	855-880	755-780	386-411	286-311	490	500	C20615	
	800 x 1000	785-810	985-1010	755-780	955-980	286-311	486-511	490	500	C20616	
	1000 x 800	985-1010	785-810	955-980	755-780	486-511	286-311	490	500	C20617	
	800 x 800	785-810	785-810	755-780	755-780	230-255	230-255	400	550	C20618	
	900 x 900	885-910	885-910	855-880	855-880	330-355	330-355	584	550	C20619	
	1000 x 1000	985-1010	985-1010	955-980	955-980	430-455	430-455	584	550	C20620	

Made-to-measure

Height	Width B1/B2	Radius	Product no.	Base price
1900/2000	800-1250	500	C20680	1.359,-
	800-1250	550	C20681	

Adjustment range = dimensions - 15mm / + 10mm

Extras

Height	Description	Profile	Product no.	Price
1900	Extension profile, 15mm for wall profile with 30,4mm		141001	32,-
2000			A21005	
	U-shaped enclosure stabilizer set connecting side panel with wall (1 set, 2 pcs. each)		C26001	111,-

Colours - Panel options

Profile colours	Colour code	Extra charges	Panel options		without Anti-Plaque		with Anti-Plaque	
			Glass code	Extra charges	Glass code	Extra charges		
White	055	0,-	Clear	321	0,-	322	418,-	
Silver high-gloss	069		Privatima	373	371,-	375	789,-	
Matt silver	087							

HÜPPE Classics 2 EasyEntry Rectangular

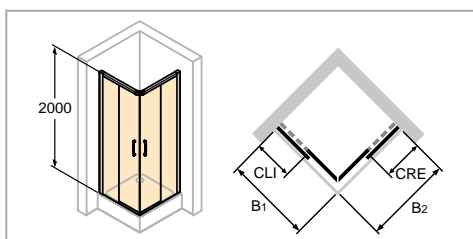
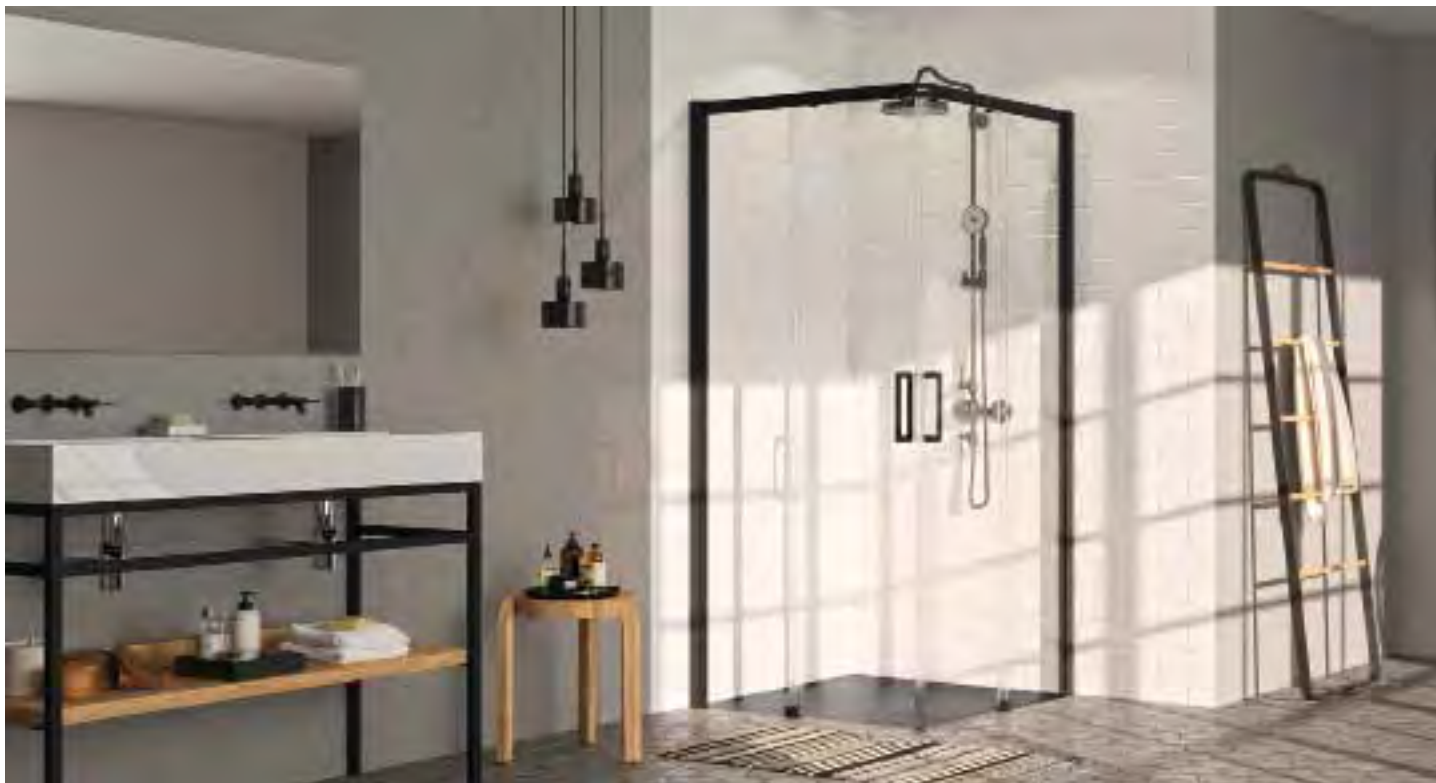

- Installation on tiles surfaces and shower trays possible. Minimum floor area required for installation: 50mm.
- Installation in U-shape possible, U-shape stabilizer set required.

	<p>Dimensions</p> <p>WL: 30,4 R: 5 Mx: M+15 MG: 20</p>
<p>WEM = Tray installation dim. (000) M = installation dimension Centre glass (001) Please always specify when ordering.</p>	

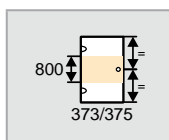
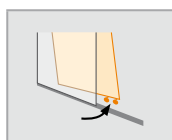
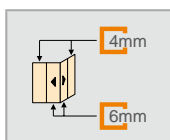

Sliding door, 2-section corner entry



Height	Model B1/B2	WEM B1/B2	M (middle of glass) B1/B2	CLI	CRE	Entry width	Product no.	Base price
2000	800x800	785-810	765-790	357-382	357-382	386	C25001	999,-
	900x900	885-910	865-890	407-432	407-432	456	C25002	
	1000x1000	985-1010	965-990	457-482	457-482	526	C25003	1.029,-
	1100x1100	1085-1110	1065-1090	557-582	557-582	526	C25004	
	1200x1200	1185-1210	1165-1190	657-682	657-682	526	C25005	

Made-to-measure

Height	Width B1/B2	Product no.	Base price
1200-2000	700-1250	C25080	1.179,-

Adjustment range = dimensions - 15mm / + 10mm

Extras

Height	Description	Profile	Product no.	Price
2000	Extension profile, 15mm for wall profile with 30,4mm		A21005	32,-
	U-shaped enclosure stabilizer set connecting side panel with wall (1 set, 2 pcs. each)		C26001	111,-

Colours - Panel options

Profile colours	Colour code	Extra charges	Panel options		without Anti-Plaque		with Anti-Plaque	
			Glass code	Extra charges	Glass code	Extra charges		
White	055	0,-	Clear	321	0,-	322	418,-	
Silver high-gloss	069		Privatima	373	371,-	375	789,-	
Matt silver	087							
Black Edition	123							

HÜPPE Classics 2 EasyEntry Rectangular

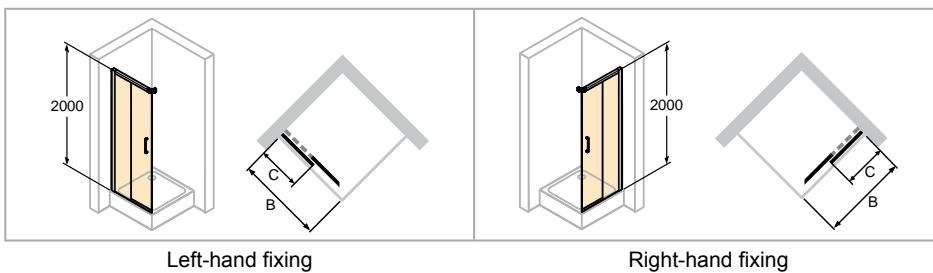

- Installation on tiles surfaces and shower trays possible. Minimum floor area required for installation: 50mm.
- Installation in U-shape possible, U-shape stabilizer set required.

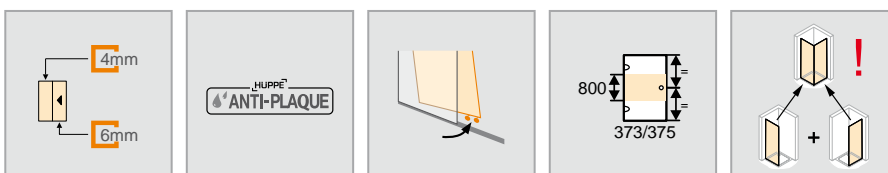
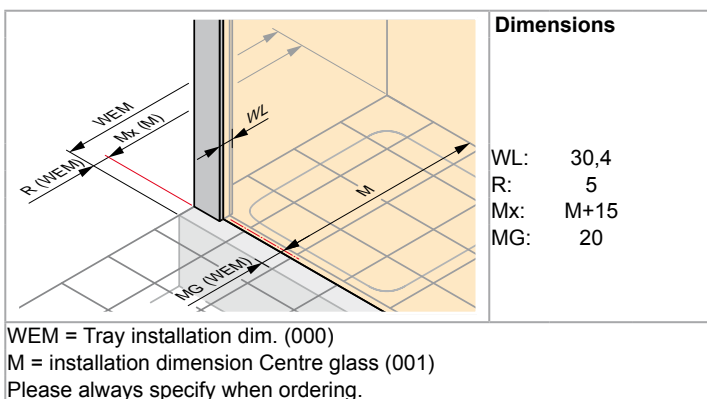

Sliding door, 2-section corner entry (1/2)

Left-hand fixing

Height	Model	WEM B	M (middle of glass) B	Width C	Product no.	Base price
2000	700	685-710	665-690	307-332	C25106	549,-
	750	735-760	715-740	357-382	C25107	
	800	785-810	765-790	357-382	C25101	
	850	835-860	815-840	407-432	C25108	
	900	885-910	865-890	407-432	C25102	
	950	935-960	915-940	457-482	C25109	
	1000	985-1010	965-990	457-482	C25103	566,-
	1050	1035-1060	1015-1040	507-532	C25110	
	1100	1085-1110	1065-1090	557-582	C25104	
	1150	1135-1160	1115-1140	607-632	C25111	581,-
	1200	1185-1210	1165-1190	657-682	C25105	

NOTE: The complete corner entry consists of two item nos.

Asymmetric combinations possible

Made-to-measure - Left-hand fixing

Height	Width B	Product no.	Base price
1200-2000	700-1250	C25180	649,-

Adjustment range = dimensions - 15mm / + 10mm

Right-hand fixing

Height	Model	WEM B	M (middle of glass) B	Width C	Product no.	Base price
2000	700	685-710	665-690	307-332	C25206	549,-
	750	735-760	715-740	357-382	C25207	
	800	785-810	765-790	357-382	C25201	
	850	835-860	815-840	407-432	C25208	
	900	885-910	865-890	407-432	C25202	
	950	935-960	915-940	457-482	C25209	
	1000	985-1010	965-990	457-482	C25203	566,-
	1050	1035-1060	1015-1040	507-532	C25210	
	1100	1085-1110	1065-1090	557-582	C25204	
	1150	1135-1160	1115-1140	607-632	C25211	581,-
	1200	1185-1210	1165-1190	657-682	C25205	

NOTE: The complete corner entry consists of two item nos.



Asymmetric combinations possible

Made-to-measure - Right-hand fixing

Height	Width B	Product no.	Base price
1200-2000	700-1250	C25280	649,-

Adjustment range = dimensions - 15mm / + 10mm

Extras

Height	Description	Profile	Product no.	Price
2000	Extension profile, 15mm for wall profile with 30,4mm		A21005	32,-
	U-shaped enclosure stabilizer set connecting side panel with wall (1 set, 2 pcs. each)		C26001	111,-

Colours - Panel options

Profile colours	Colour code	Extra charges	Panel options		without Anti-Plaque		with Anti-Plaque	
			Glass code	Extra charges	Glass code	Extra charges		
White	055	0,-	Clear	321	0,-	322	209,-	
Silver high-gloss	069		Privatima	373	186,-	375	395,-	
Matt silver	087							
Black Edition	123							

HÜPPE Classics 2 EasyEntry Rectangular

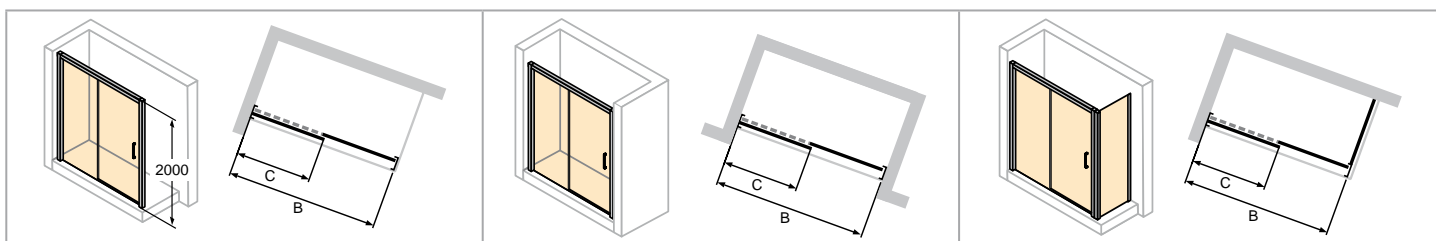

Left-hand fixing

- Installation on tiles surfaces and shower trays possible. Minimum floor area required for installation: 50mm.
- Installation in U-shape possible, U-shape stabilizer set required.
- NOTE: Installation scenario door in recess, door for side panel or installation in U-shape must be specified in the text for made-to-measure orders.

Dimensions	
	<p>WL: 30,4</p> <p>R: 5</p> <p>Mx: M+15</p> <p>MG: 20</p>
<p>WEM = Tray installation dim. (000)</p> <p>M = installation dimension Centre glass (001)</p> <p>Please always specify when ordering.</p>	

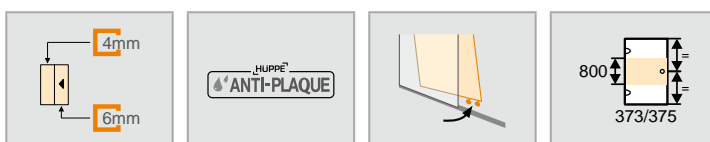

Sliding door, 1-panel with fixed segment

Left-hand fixing

Height	Model	WEM In recess	WEM Side panel	M (middle of glass) Recess	M (middle of glass) Side panel	Width C	Entry width	Product no.	Base price
2000	1000	970-1020	985-1030	970-1020	965-1010	446-471	362	C25301	905,-
	1100	1070-1120	1085-1130	1070-1120	1065-1110	507-532	428	C25302	
	1150	1120-1170	1135-1180	1120-1170	1115-1160	557-582	428	C25303	
	1200	1170-1220	1185-1230	1170-1220	1165-1210	557-582	478	C25309	933,-
	1250	1220-1270	1235-1280	1220-1270	1215-1260	607-632	478	C25304	
	1300	1270-1320	1285-1330	1270-1320	1265-1310	607-632	528	C25310	
	1350	1320-1370	1335-1380	1320-1370	1315-1360	657-682	528	C25305	
	1400	1370-1420	1385-1430	1370-1420	1365-1410	657-682	578	C25311	
	1450	1420-1470	1435-1480	1420-1470	1415-1460	707-732	578	C25306	
	1500	1470-1520	1485-1530	1470-1520	1465-1510	707-732	628	C25312	
	1550	1520-1570	1535-1580	1520-1570	1515-1560	757-782	628	C25307	
	1600	1570-1620	1585-1630	1570-1620	1565-1610	807-832	628	C25313	
	1650	1620-1670	1635-1680	1620-1670	1615-1660	857-882	628	C25308	
1700	1670-1720	1685-1730	1670-1720	1665-1710	907-932	628	C25314		
1800	1770-1820	1785-1830	1770-1820	1765-1810	957-982	678	C25315	959,-	

Made-to-measure - Left-hand fixing

Height	Width B	Product no.	Base price
1200-2000	1000-1800	C25380	1.069,-

Adjustment range GTN = dimensions - 30mm / + 20mm

Adjustment range GTS = dimensions - 15mm / + 30mm

Right-hand fixing

Height	Model	WEM In recess	WEM Side panel	M (middle of glass) Recess	M (middle of glass) Side panel	Width C	Entry width	Product no.	Base price
2000	1000	970-1020	985-1030	970-1020	965-1010	446-471	362	C25601	905,-
	1100	1070-1120	1085-1130	1070-1120	1065-1110	507-532	428	C25602	
	1150	1120-1170	1135-1180	1120-1170	1115-1160	557-582	428	C25603	
	1200	1170-1220	1185-1230	1170-1220	1165-1210	557-582	478	C25609	933,-
	1250	1220-1270	1235-1280	1220-1270	1215-1260	607-632	478	C25604	
	1300	1270-1320	1285-1330	1270-1320	1265-1310	607-632	528	C25610	
	1350	1320-1370	1335-1380	1320-1370	1315-1360	657-682	528	C25605	
	1400	1370-1420	1385-1430	1370-1420	1365-1410	657-682	578	C25611	
	1450	1420-1470	1435-1480	1420-1470	1415-1460	707-732	578	C25606	
	1500	1470-1520	1485-1530	1470-1520	1465-1510	707-732	628	C25612	
	1550	1520-1570	1535-1580	1520-1570	1515-1560	757-782	628	C25607	
	1600	1570-1620	1585-1630	1570-1620	1565-1610	807-832	628	C25613	
	1650	1620-1670	1635-1680	1620-1670	1615-1660	857-882	628	C25608	
1700	1670-1720	1685-1730	1670-1720	1665-1710	907-932	628	C25614		
1800	1770-1820	1785-1830	1770-1820	1765-1810	957-982	678	C25615	959,-	



Made-to-measure - Right-hand fixing

Height	Width B	Product no.	Base price
1200-2000	1000-1800	C25680	1.069,-

Adjustment range GTN = dimensions - 30mm / + 20mm

Adjustment range GTS = dimensions - 15mm / + 30mm

Extras

Height	Profile	Product no.	Price
2000	Extension profile, 15mm for wall profile with 30,4mm 	A21005	32,-
	U-shaped enclosure stabilizer set connecting side panel with wall (1 set, 2 pcs. each) 	C26001	111,-

Colours - Panel options

Profile colours	Colour code	Extra charges	Panel options		without Anti-Plaque		with Anti-Plaque	
			Glass code	Extra charges	Glass code	Extra charges		
White	055	0,-	Clear	321	0,-	322	209,-	
Silver high-gloss	069		Privatima	373	186,-	375	395,-	
Matt silver	087							
Black Edition	123		171,-					

HÜPPE Classics 2 EasyEntry Rectangular

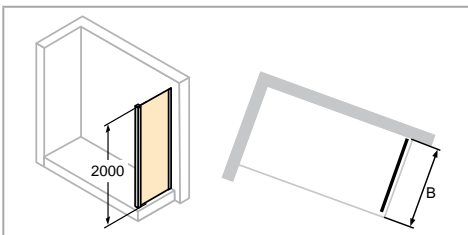

- Cannot be ordered as a free-standing side panel.

Dimensions

WL:	30,4	20
R:	5	5
Mx:	M+15	M+15
MG:	20	20

WEM = Tray installation dim. (000)
M = installation dimension Centre glass (001)
Please always specify when ordering.

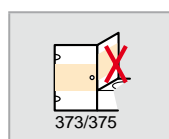
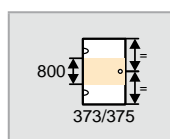
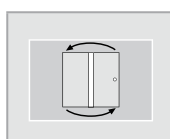
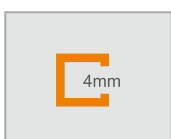

Side panel for sliding door

Height	Model	WEM B	M (middle of glass) B	Product no.	Base price
2000	SW 700	685-710	665-690	C25401	426,-
	SW 750	735-760	715-740	C25402	
	SW 800	785-810	765-790	C25403	
	SW 900	885-910	865-890	C25404	440,-
	SW 1000	985-1010	965-990	C25405	
	SW 1100	1085-1110	1065-1090	C25406	
	SW 1200	1185-1210	1165-1190	C25407	

Made-to-measure



Height	Model	Width B	Product no.	Base price
500-2000	Standard made-to-measure	200-1200	C25480	504,-
	In-line configuration	200-1200	C25481	
	On bathtub	200-1200	C25482	

Adjustment range = dimensions - 15mm / + 10mm

Slopes and cut-outs

Slopes and cut-outs	Supplement
	Supplement per slope/cut-out for made-to-measure 170,-

Extras

Height	Profile	Product no.	Price
2000	Extension profile, 15mm for wall profile with 30,4mm 	A21005	32,-
	U-shaped enclosure stabilizer set connecting side panel with wall (1 set, 2 pcs. each) 	C26001	111,-

Colours - Panel options

Profile colours	Colour code	Extra charges	Panel options		without Anti-Plaque		with Anti-Plaque	
			Glass code	Extra charges	Glass code	Extra charges		
White	055	0,-	Clear	321	0,-	322	209,-	
Silver high-gloss	069		Privatima	373	186,-	375	395,-	
Matt silver	087							
Black Edition	123		171,-					

HÜPPE Classics 2 EasyEntry Quadrant

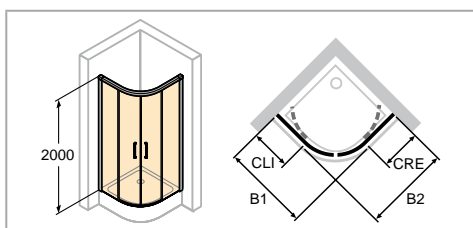

- Installation in U-shape possible, U-shape stabilizer set required.

	<p>Dimensions</p> <p>WL: 30,4 R: 5 Mx: M+15 MG: 20</p>
<p>WEM = Tray installation dim. (000) M = installation dimension Centre glass (001) Please always specify when ordering.</p>	

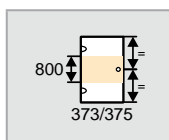
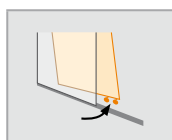
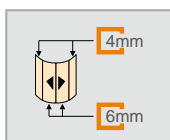

Sliding door



Height	Model B1/B2	WEM B1	WEM B2	M (middle of glass) B1	M (middle of glass) B2	CLI	CRE	Entry width	Radius	Product no.	Base price
2000	800 x 800	785-810	785-810	765-790	765-790	287-312	287-312	450	500	C25501	1.152,-
	900 x 900	885-910	885-910	865-890	865-890	387-412	387-412	485	500	C25502	
	1000 x 1000	985-1010	985-1010	965-990	965-990	487-512	487-512	485	500	C25503	1.187,-
	1100 x 1100	1085-1110	1085-1110	1065-1090	1065-1090	587-612	587-612	485	500	C25504	
	1200 x 1200	1185-1210	1185-1210	1165-1190	1165-1190	687-712	687-712	485	500	C25505	1.218,-
	800 x 800	785-810	785-810	765-790	765-790	237-262	237-262	390	550	C25506	
	900 x 900	885-910	885-910	865-890	865-890	337-362	337-362	525	550	C25507	1.152,-
	1000 x 1000	985-1010	985-1010	965-990	965-990	437-462	437-462	525	550	C25508	
	1100 x 1100	1085-1110	1085-1110	1065-1090	1065-1090	537-562	537-562	525	550	C25509	1.187,-
1200 x 1200	1185-1210	1185-1210	1165-1190	1165-1190	637-662	637-662	525	550	C25510		

Made-to-measure

Height	Width B1/B2	Radius	Product no.	Base price
2000	800-1250	500	C25580	1.359,-
	800-1250	550	C25581	

Adjustment range = dimensions - 15mm / + 10mm

Extras

Height	Description	Profile	Product no.	Price
2000	Extension profile, 15mm for wall profile with 30,4mm		A21005	32,-
	U-shaped enclosure stabilizer set connecting side panel with wall (1 set, 2 pcs. each)		C26001	111,-

Colours - Panel options

Profile colours	Colour code	Extra charges	Panel options		without Anti-Plaque		with Anti-Plaque	
			Glass code	Extra charges	Glass code	Extra charges		
White	055	0,-	Clear	321	0,-	322	418,-	
Silver high-gloss	069		Privatima	373	371,-	375	789,-	
Matt silver	087							
Black Edition	123							

HÜPPE Classics 2 Rectangular

Sliding door as U-shaped enclosure

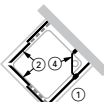
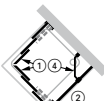
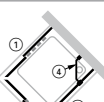
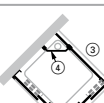
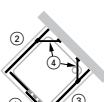
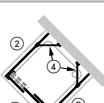
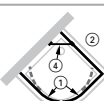
For ...		Item no.		
	Consisting of:	1 2 4	Side panel for sliding door Sliding door, 2-section corner entry Stabilizer set for U-shaped enclosures C26001. See accessory side panel.	
	Consisting of:	1 2 4	Sliding door, 3-section corner entry Side panel for sliding door Stabilizer set for U-shaped enclosures C26001. See accessory side panel.	
	Consisting of:	1 2 3 4	Sliding door, 2-section corner entry (1/2) Sliding door, 2-section corner entry (1/2) Side panel for sliding door Stabilizer set for U-shaped enclosures C26001. See accessory side panel.	
	Consisting of:	1 2 3 4	Sliding door, 3-section corner entry (1/2) Sliding door, 3-section corner entry (1/2) Side panel for sliding door Stabilizer set for U-shaped enclosures C26001. See accessory side panel.	
	Consisting of:	1 2 3 4	Sliding door, 1-panel with fixed segment Side panel for sliding door Side panel for sliding door Stabilizer set for U-shaped enclosures C26001. See accessory side panel.	
	Consisting of:	1 2 3 4	2-panel sliding door with fixed segment Side panel for sliding door Side panel for sliding door Stabilizer set for U-shaped enclosures C26001. See accessory side panel.	
	Consisting of:	1 2 4	Quadrant sliding door Side panel for sliding door Stabilizer set for U-shaped enclosures C26001. See accessory side panel.	

It must be stated whether the specified dimensions refer to the tray installation dimensions or the middle glass installation dimensions (e.g. floor-flush).

The following therefore needs to be specified in the order with respect to dimensions:

Refers to the tray installation dimensions: 000

Refers to the middle glass installation dimensions: 001

Sliding door as U-shaped enclosure

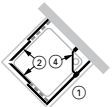
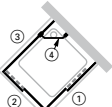
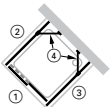
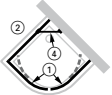
For ...		Item no.		
	Consisting of:	1 2 4	Side panel for sliding door Sliding door, 2-panel corner entry, left Stabilizer set for U-shaped enclosures C26001. See accessory side panel.	
	Consisting of:	1 2 3 4	Sliding door, 2-section corner entry (1/2), right Sliding door, 2-section corner entry (1/2), left Side panel for sliding door Stabilizer set for U-shaped enclosures C26001. See accessory side panel.	
	Consisting of:	1 2 3 4	Sliding door, 1-panel with fixed segment Side panel for sliding door Side panel for sliding door Stabilizer set for U-shaped enclosures C26001. See accessory side panel.	
	Consisting of:	1 2 4	Quadrant sliding door Side panel for sliding door Stabilizer set for U-shaped enclosures C26001. See accessory side panel.	

It must be stated whether the specified dimensions refer to the tray installation dimensions or the middle glass installation dimensions (e.g. floor-flush).

The following therefore needs to be specified in the order with respect to dimensions:

Refers to the tray installation dimensions: 000

Refers to the middle glass installation dimensions: 001

HÜPPE Classics 2 swing door combination options

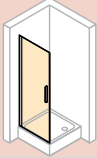
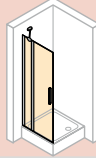
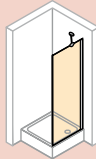
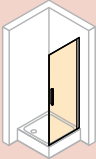
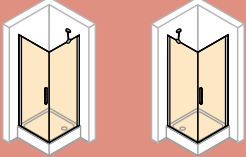
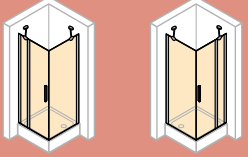
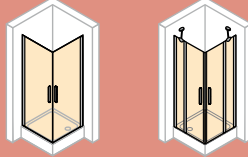
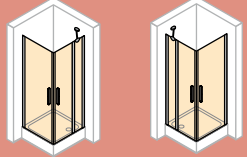
 <p>800 900 1000</p>		 <p>800 900 1000 1200</p>	
+			
 <p>700 750 800 900 1000</p>		 <p>800 900 1000</p>	
=		=	
			
<p>800 x 800 900 x 900 1000 x 1000</p> <p>800 x 700 / 700 x 800 800 x 750 / 750 x 800 800 x 900 / 900 x 800 800 x 1000 / 1000 x 800 900 x 700 / 700 x 900 900 x 750 / 750 x 900 900 x 800 / 800 x 900 900 x 1000 / 1000 x 900 1000 x 700 / 700 x 1000 1000 x 750 / 750 x 1000 1000 x 800 / 800 x 1000 1000 x 900 / 900 x 1000</p>		<p>800 x 800 900 x 900 1000 x 1000</p> <p>800 x 700 / 700 x 800 800 x 750 / 750 x 800 800 x 900 / 900 x 800 800 x 1000 / 1000 x 800 900 x 700 / 700 x 900 900 x 750 / 750 x 900 900 x 800 / 800 x 900 900 x 1000 / 1000 x 900 1000 x 700 / 700 x 1000 1000 x 750 / 750 x 1000 1000 x 800 / 800 x 1000 1000 x 900 / 900 x 1000 1200 x 700 / 700 x 1200 1200 x 750 / 750 x 1200 1200 x 800 / 800 x 1200 1200 x 900 / 900 x 1200 1200 x 1000 / 1000 x 1200</p>	
			
		<p>800 x 800 900 x 900 1000 x 1000</p> <p>800 x 900 800 x 1000 900 x 800 1000 x 800 1000 x 900</p>	
			
		<p>800 x 800 900 x 900 1000 x 1000</p> <p>800 x 900 / 900 x 800 800 x 1000 / 1000 x 800 800 x 1200 / 1200 x 800 900 x 800 / 800 x 900 900 x 1000 / 1000 x 900 900 x 1200 / 1200 x 900 1000 x 800 / 800 x 1000 1000 x 900 / 900 x 1000 1000 x 1200 / 1200 x 1000</p>	

HÜPPE Classics 2 swing door combination options

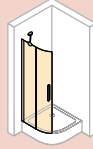

800
900
1000

+

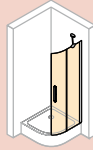

800
900
1000

=

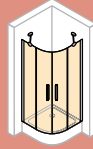

800 x 800
900 x 900
1000 x 1000
800 x 900 / 900 x 800
800 x 1000 / 1000 x 800
900 x 1000 / 1000 x 900

HÜPPE Classics 2 Rectangular

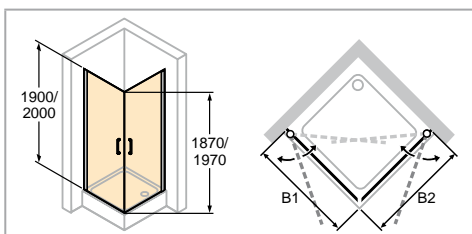

Dimensions	
	<p>WL: 25 R: 15 Mx: M+15 MG: 30</p>
<p>WEM = Tray installation dim. (000) M = installation dimension Centre glass (001) Please always specify when ordering.</p>	

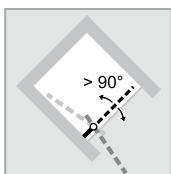
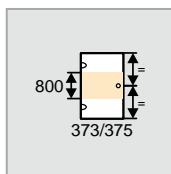
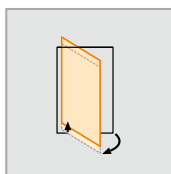
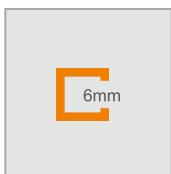

Swing door corner entry

Height	Model	WEM B1/B2	M (middle of glass) B1/B2	Entry width	Product no.	Base price
1900	800x800	785-800	755-770	960	C23301	1.243,-
	900x900	885-900	855-870	1100	C23302	
	1000x1000	985-1000	955-970	1242	C23303	
2000	800x800	785-800	755-770	960	C23304	1.368,-
	900x900	885-900	855-870	1100	C23305	
	1000x1000	985-1000	955-970	1242	C23306	

Made-to-measure

Height	Width B1/B2	Product no.	Base price
1400-2000	500-1100	C23380	1.617,-

Adjustment range = dimensions - 8mm / + 7mm

Slopes and cut-outs

Slopes and cut-outs	Extra charges
 Supplement per slope/cut-out for made-to-measure	170,-

Extras

Height	Profile	Product no.	Price
1900		178002	32,-
2000		178006	

Colours - Panel options

Profile colours	Colour code	Extra charges	Panel options			
			without Anti-Plaque Glass code	with Anti-Plaque Glass code		
White	055	0,-	Clear 321	0,-	322	418,-
Silver high-gloss	069		Privatima 373	371,-	375	789,-
Matt silver	087					

HÜPPE Classics 2 Rectangular

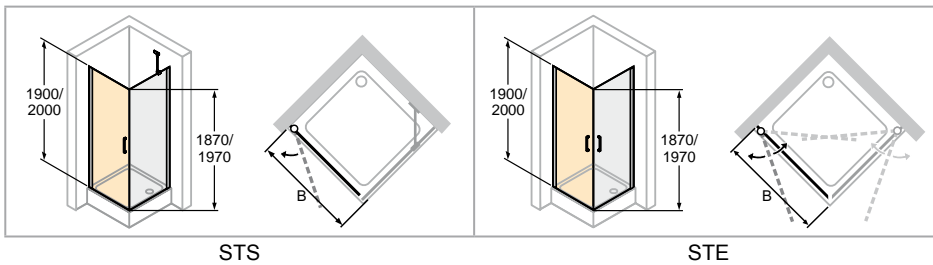

- STS: Only outwards opening. Inwards opening also possible with inwards/outwards opening supplement set.
- STE: Opens in- and outwards

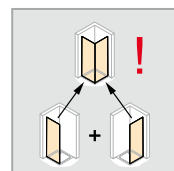
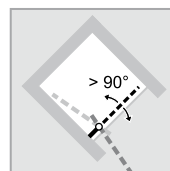
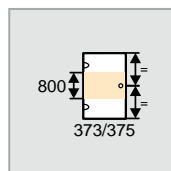
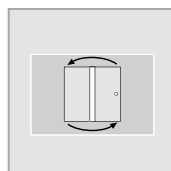
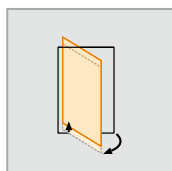
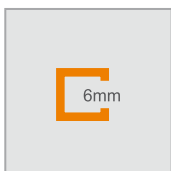
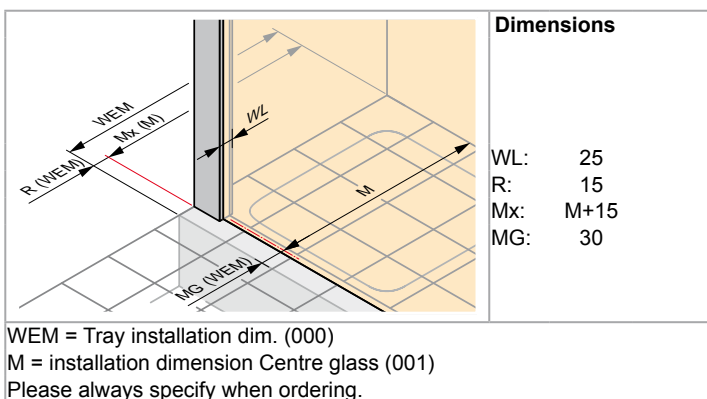

Swing door for side panel/Corner entry

Height	Model	WEM STS/STE	M (middle of glass) STS/STE	Entry width STS	Entry width STE	Product no.	Base price
1900	800	785-800	755-770	685	960	C23401	663,-
	900	885-900	855-870	785	1100	C23402	
	1000	985-1000	955-970	885	1242	C23403	683,-
2000	800	785-800	755-770	685	960	C23404	729,-
	900	885-900	855-870	785	1100	C23405	
	1000	985-1000	955-970	885	1242	C23406	751,-

NOTE: The complete corner entry consists of two item nos.

Made-to-measure

Height	Width B	Product no.	Base price
1400-2000	500-1100	C23480	862,-

Adjustment range = dimensions - 8mm / + 7mm

Slopes and cut-outs

Slopes and cut-outs	Extra charges
 Supplement per slope/cut-out for made-to-measure	170,-

Extras

Height	Profile	Product no.	Price
1900	Extension profile, 15mm	178002	32,-
	Extension profile, 15mm	178006	
2000	Inwards/outwards opening supplement set (can be shortened on site). Only suitable for 6mm door and side panel.	ZB0001	119,-
	Inwards/outwards opening supplement set (can be shortened on site). Only suitable for 6mm door and 8mm side panel.	ZB0002	

Colours - Panel options

Profile colours	Colour code	Extra charges	Panel options		without Anti-Plaque		with Anti-Plaque	
			Glass code	Extra charges	Glass code	Extra charges		
White	055	0,-	Clear	321	0,-	322	209,-	
Silver high-gloss	069		Privatima	373	186,-	375	395,-	
Matt silver	087							

HÜPPE Classics 2 Rectangular

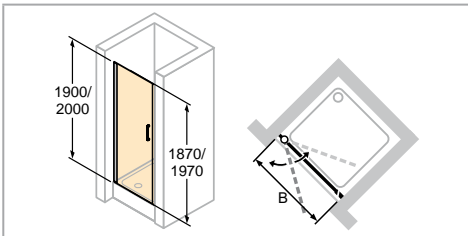

Dimensions	
WL:	25
R:	15
Mx:	M+15
MG:	30

WEM = Tray installation dim. (000)
M = installation dimension Centre glass (001)
Please always specify when ordering.

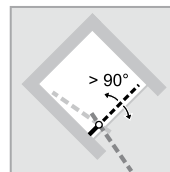
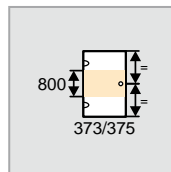
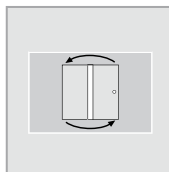
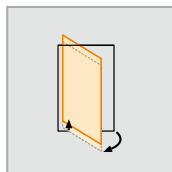
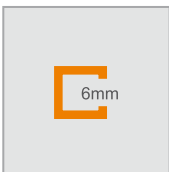

Swing door in recess

Height	Model	WEM In recess	M (middle of glass) Recess	Entry width	Product no.	Base price
1900	780	765-795	765-795	665	C23507	722,-
	800	785-815	785-815	685	C23501	
	880	865-895	865-895	765	C23508	
	900	885-915	885-915	785	C23502	742,-
	980	965-995	965-995	865	C23509	
	1000	985-1015	985-1015	885	C23503	
2000	780	765-795	765-795	665	C23510	792,-
	800	785-815	785-815	685	C23504	
	880	865-895	865-895	765	C23511	
	900	885-915	885-915	785	C23505	816,-
	980	965-995	965-995	865	C23512	
	1000	985-1015	985-1015	885	C23506	

Made-to-measure

Height	Width B	Product no.	Base price
1400-2000	500-1100	C23580	937,-

Adjustment range = dimensions - 8mm / + 22mm

Slopes and cut-outs

Slopes and cut-outs	Extra charges
	Supplement per slope/cut-out for made-to-measure 170,-

Extras

Height	Profile	Product no.	Price
1900	Extension profile, 15mm	178002	32,-
2000	Extension profile, 15mm	178006	

Colours - Panel options

Profile colours	Colour code	Extra charges	Panel options		without Anti-Plaque		with Anti-Plaque	
			Glass code	Extra charges	Glass code	Extra charges		
White	055	0,-	Clear	321	0,-	322	209,-	
Silver high-gloss	069		Privatima	373	186,-	375	395,-	
Matt silver	087							

HÜPPE Classics 2 Rectangular

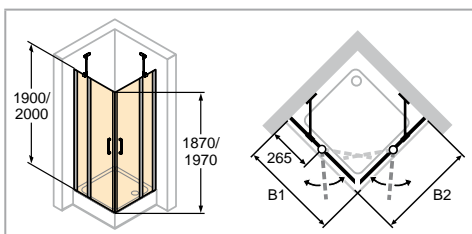

Dimensions	
	WL: 25 R: 15 Mx: M+15 MG: 30
WEM = Tray installation dim. (000) M = installation dimension Centre glass (001) Please always specify when ordering.	

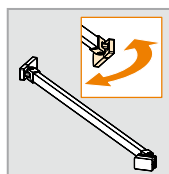
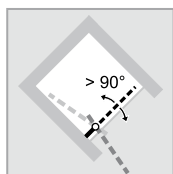
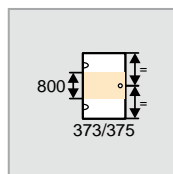
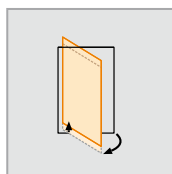
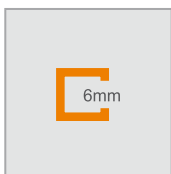

Swing door corner entry with fixed segments

Height	Model	WEM B1/B2	M (middle of glass) B1/B2	Entry width	Product no.	Base price
1900	800x800	785-800	755-770	655	C23001	1.303,-
	900x900	885-900	855-870	799	C23002	
	1000x1000	985-1000	955-970	940	C23003	
2000	800x800	785-800	755-770	655	C23004	1.432,-
	900x900	885-900	855-870	799	C23005	
	1000x1000	985-1000	955-970	940	C23006	

Made-to-measure

Height	Width B1/B2	Product no.	Base price
1400-2000	700-1550	C23080	1.693,-

Individual width possible for the fixed segment(s).

Adjustment range = dimensions - 8mm / + 7mm

Slopes and cut-outs

Slopes and cut-outs	Extra charges
 Supplement per slope/cut-out for made-to-measure	170,-

Extras

Height	Profile	Product no.	Price
1900		178003	32,-
2000		178007	

Colours - Panel options

Profile colours	Colour code	Extra charges	Panel options		without Anti-Plaque		with Anti-Plaque	
			Glass code	Extra charges	Glass code	Extra charges		
White	055	0,-	Clear	321	0,-	322	418,-	
Silver high-gloss	069		Privatima	373	371,-	375	789,-	
Matt silver	087							

HÜPPE Classics 2 Rectangular

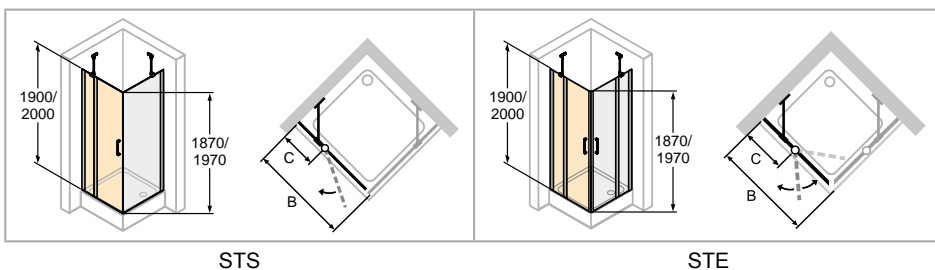

- STS: Only outwards opening. Inwards opening also possible with inwards/outwards opening supplement set.
- STE: Opens in- and outwards

Glass 373/375 Privatima: Specification in the order whether left-hand or right-hand fixing.

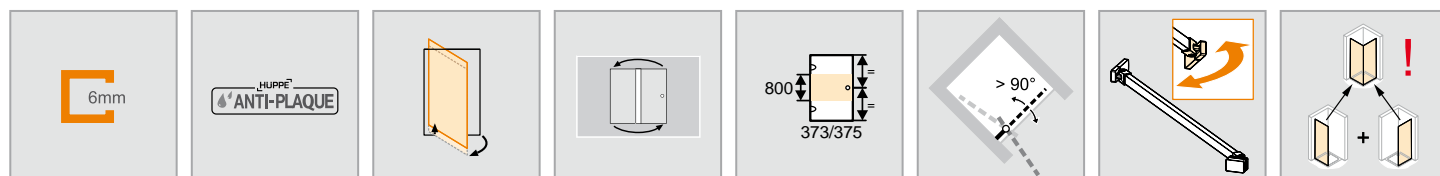
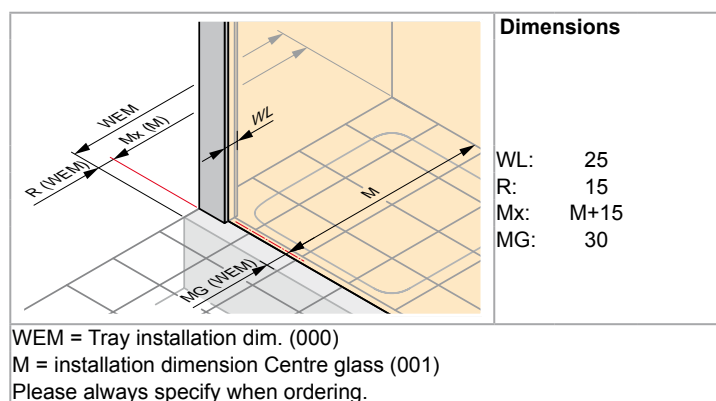

Swing door with fixed segment for side panel/corner entry

Height	Model	WEM STS/STE	M (middle of glass) STS/STE	Width of fixed segment C	Entry width STS	Entry width STE	Product no.	Base price
1900	800	785-800	755-770	261-276	470	655	C23101	698,-
	900	885-900	855-870	261-276	570	799	C23102	
	1000	985-1000	955-970	261-276	670	940	C23103	720,-
	1200	1185-1200	1155-1170	461-476	670	940	C23107	740,-
2000	800	785-800	755-770	261-276	470	655	C23104	767,-
	900	885-900	855-870	261-276	570	799	C23105	
	1000	985-1000	955-970	261-276	670	940	C23106	790,-
	1200	1185-1200	1155-1170	461-476	670	940	C23108	813,-

NOTE: The complete corner entry consists of two item nos.

Made-to-measure

Height	Width B	Product no.	Base price
1400-2000	700-1550	C23180	906,-

Individual width possible for the fixed segment(s).

Adjustment range = dimensions - 8mm / + 7mm

Slopes and cut-outs

Slopes and cut-outs	Extra charges
	Supplement per slope/cut-out for made-to-measure 170,-

Extras

Height	Profile	Product no.	Price
1900		Extension profile, 15mm 178003	32,-
		Extension profile, 15mm 178007	
2000		Inwards/outwards opening supplement set (can be shortened on site). Only suitable for 6mm door and side panel. ZB0001	119,-
		Inwards/outwards opening supplement set (can be shortened on site). Only suitable for 6mm door and 8mm side panel. ZB0002	

Colours - Panel options

Profile colours	Colour code	Extra charges	Panel options		without Anti-Plaque		with Anti-Plaque	
			Glass code	Extra charges	Glass code	Extra charges		
White	055	0,-	Clear	321	0,-	322	209,-	
Silver high-gloss	069		Privatima	373	186,-	375	395,-	
Matt silver	087							

HÜPPE Classics 2 Rectangular

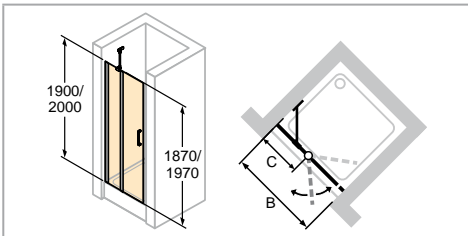

Glass 373/375 Privatima: Specification in the order whether left-hand or right-hand fixing.

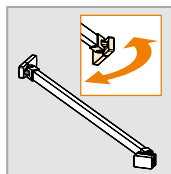
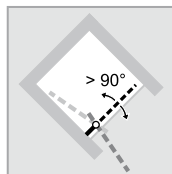
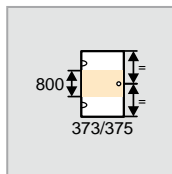
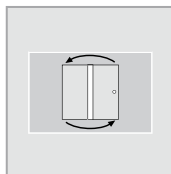
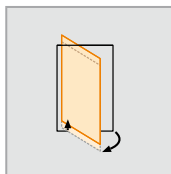
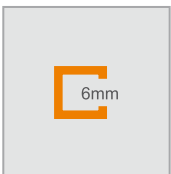
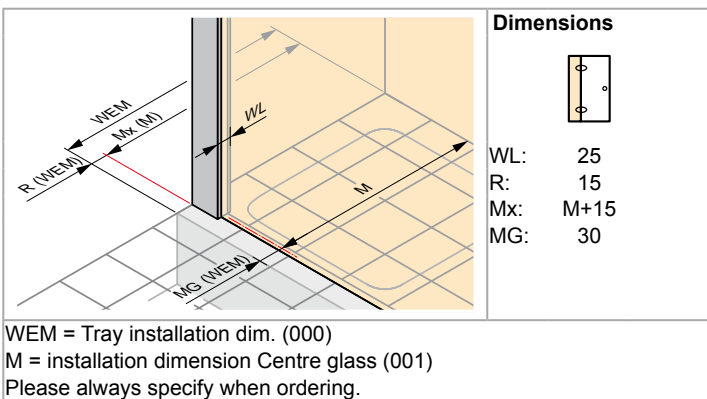

Swing door with fixed segment in recess

Height	Model	WEM In recess	M (middle of glass) Recess	Width of fixed seg- ment C	Entry width	Product no.	Base price
1900	780	765-795	765-795	261-276	450	C23207	756,-
	800	785-815	785-815	261-276	470	C23201	
	880	865-895	865-895	261-276	550	C23208	
	900	885-915	885-915	261-276	570	C23202	779,-
	980	965-995	965-995	261-276	650	C23209	
	1000	985-1015	985-1015	261-276	670	C23203	
2000	1200	1185-1215	1185-1215	461-476	670	C23213	802,-
	780	765-795	765-795	261-276	450	C23210	831,-
	800	785-815	785-815	261-276	470	C23204	
	880	865-895	865-895	261-276	550	C23211	
	900	885-915	885-915	261-276	570	C23205	
	980	965-995	965-995	261-276	650	C23212	856,-
	1000	985-1015	985-1015	261-276	670	C23206	
	1200	1185-1215	1185-1215	461-476	670	C23214	879,-

Made-to-measure

Height	Width B	Product no.	Base price
1400-2000	700-1550	C23280	982,-

Individual width possible for the fixed segment(s).

Adjustment range = dimensions - 8mm / + 22mm

Slopes and cut-outs

Slopes and cut-outs	Extra charges
	Supplement per slope/cut-out for made-to-measure 170,-

Extras

Height	Profile	Product no.	Price
1900	Extension profile, 15mm	178003	32,-
2000	Extension profile, 15mm	178007	

Colours - Panel options

Profile colours	Colour code	Extra charges	Panel options	without Anti-Plaque		with Anti-Plaque	
				Glass code	Extra charges	Glass code	Extra charges
White	055	0,-	Clear	321	0,-	322	209,-
Silver high-gloss	069		Privatima	373	186,-	375	395,-
Matt silver	087						

HÜPPE Classics 2 Rectangular

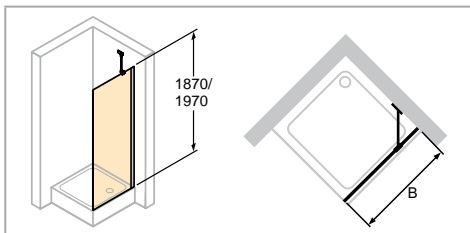

- Cannot be ordered as a free-standing side panel.
- Towel rail height can be selected individually and must be specified with the order. If nothing is specified, the towel rail is always delivered middle of glass (height and width).

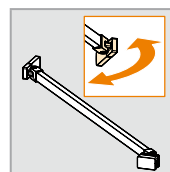
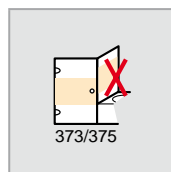
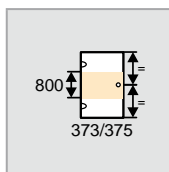
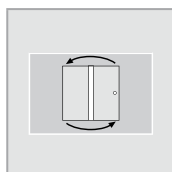
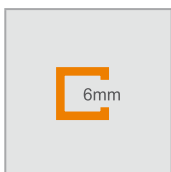
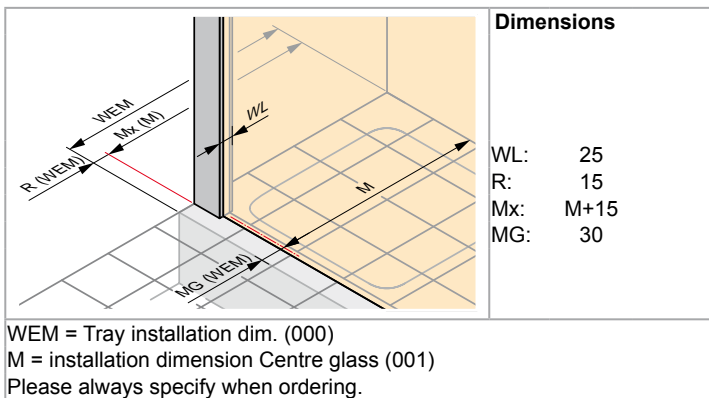

Side panel for swing door

Height	Model	WEM B	M (middle of glass) B	Product no.	Base price
1900	SW 700	685-700	655-670	C23601	442,-
	SW 750	735-750	705-720	C23602	
	SW 800	785-800	755-770	C23603	
	SW 900	885-900	855-870	C23604	
	SW 1000	985-1000	955-970	C23605	
2000	SW 700	685-700	655-670	C23606	486,-
	SW 750	735-750	705-720	C23607	
	SW 800	785-800	755-770	C23608	
	SW 900	885-900	855-870	C23609	
	SW 1000	985-1000	955-970	C23610	

Made-to-measure

Height	Model	Width B	Fixing	Product no.	Base price
500-2000	Standard made-to-measure	200-1200	Stabilizer	C23680	574,-
	In-line configuration	200-599 600-1200	Stabilizer Cross bar	C23681	
	On bathtub (only with door in recess)	200-1200	Stabilizer	C23682	

Adjustment range = dimensions - 8mm / + 7mm

Slopes and cut-outs

Slopes and cut-outs	Extra charges
 Supplement per slope/cut-out for made-to-measure	170,-

Special options

Optional variants	Product no.	Extra charges
Towel rail (silver high-gloss)	T99	210,-

Colours - Panel options

Profile colours	Colour code	Extra charges	Panel options		without Anti-Plaque		with Anti-Plaque	
			Glass code	Extra charges	Glass code	Extra charges		
White	055	0,-	Clear	321	0,-	322	209,-	
Silver high-gloss	069		Privatima	373	186,-	375	395,-	
Matt silver	087							

HÜPPE Classics 2 Rectangular

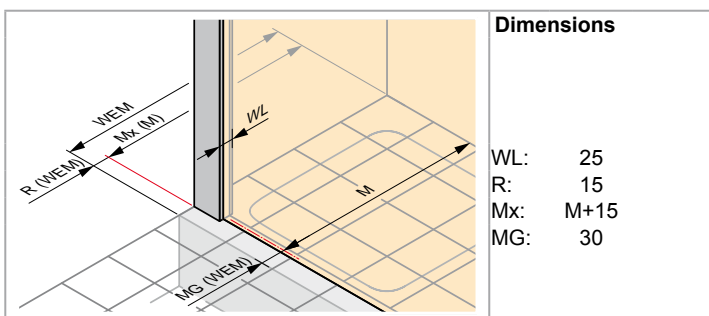
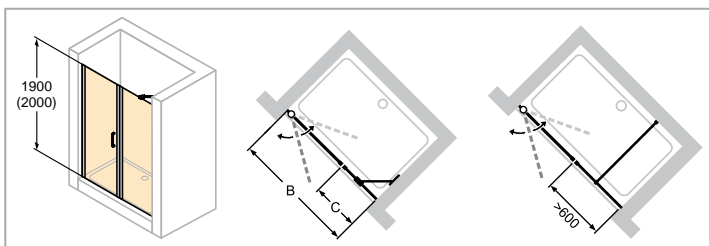

Dimensions

- WL: 25
- R: 15
- Mx: M+15
- MG: 30

WEM = Tray installation dim. (000)
 M = installation dimension Centre glass (001)
 Please always specify when ordering.

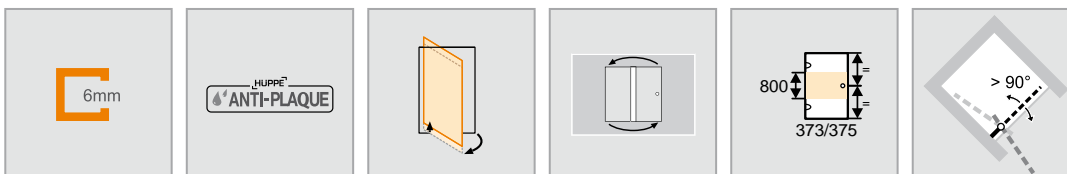

Swing door with additional section in recess

Height	Model	WEM B	M (middle of glass) B	Width C	Entry width	Product no.	Base price
1900	900	885-915	885-915	235-250	580	C24701	998,-
	1000	985-1015	985-1015	235-250	680	C24702	1.038,-
	1100	1085-1115	1085-1115	335-350	680	C24703	1.029,-
	1200	1185-1215	1185-1215	435-450	680	C24704	1.043,-
	1400	1385-1415	1385-1415	535-550	780	C24705	
2000	900	885-915	885-915	235-250	580	C24706	1.098,-
	1000	985-1015	985-1015	235-250	680	C24707	1.141,-
	1100	1085-1115	1085-1115	335-350	680	C24708	1.130,-
	1200	1185-1215	1185-1215	435-450	680	C24709	1.142,-
	1400	1385-1415	1385-1415	535-550	780	C24710	

Made-to-measure

Height	Width B	Product no.	Base price
1400-2000	700-1200	C24780	1.298,-
	1201-1600	C24781	1.492,-
	1601-2200	C24782	1.716,-

Adjustment range = dimensions - 15mm / + 15mm

Min. width of additional section: 190mm.

Max. width of door panel: 1000mm.

The width of the additional section must be stated.

Slopes and cut-outs

Slopes and cut-outs	Extra charges
 Supplement per slope/cut-out for made-to-measure	170,-

Extras

Height	Profile	Product no.	Price
1900		178002	32,-
2000		178006	

Colours - Panel options

Profile colours	Colour code	Extra charges	Panel options		without Anti-Plaque		with Anti-Plaque	
			Glass code	Extra charges	Glass code	Extra charges		
White	055	0,-	Clear	321	0,-	322	209,-	
Silver high-gloss	069		Privatima	373	186,-	375	395,-	
Matt silver	087							

HÜPPE Classics 2 Rectangular

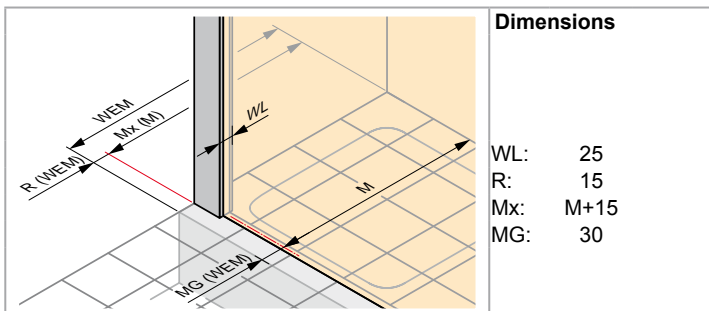
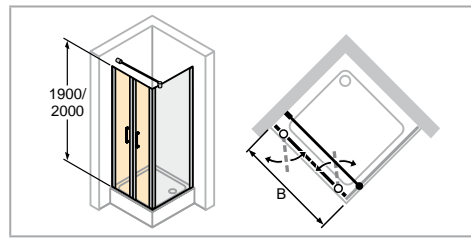
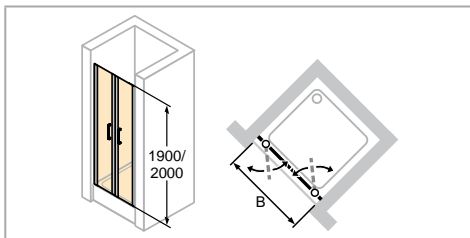

WEM = Tray installation dim. (000)
 M = installation dimension Centre glass (001)
 Please always specify when ordering.

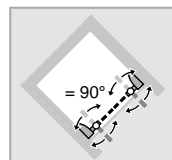
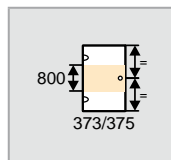
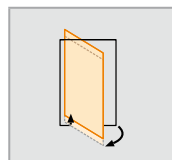
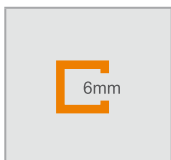

Two-way door in recess

Height	Model	WEM B	M (middle of glass) B	Entry width	Product no.	Base price	
1900	780	760-785	760-785	620	C23707	756,-	
	800	780-805	780-805	640	C23701		
	880	860-885	860-885	720	C23708		
	2000	900	880-905	880-905	740	C23702	779,-
		980	960-985	960-985	820	C23709	
		1000	980-1005	980-1005	840	C23703	
780		760-785	760-785	620	C23710	831,-	
800	780-805	780-805	640	C23704			
880	860-885	860-885	720	C23711			
2000	900	880-905	880-905	740	C23705	856,-	
	980	960-985	960-985	820	C23712		
	1000	980-1005	980-1005	840	C23706		

Made-to-measure

Height	Model	Width B	Product no.	Base price
1400-2000	Standard made-to-measure	500-1800	C23780	982,-

Adjustment range = dimensions - 13mm / + 12mm

Two-way door for side panel

Height	Model	WEM B	M (middle of glass) B	Entry width	Product no.	Base price
1900	800	775-805	745-775	600	C23801	756,-
	900	875-905	845-875	700	C23802	
	1000	975-1005	945-975	800	C23803	779,-
2000	800	775-805	745-775	600	C23804	831,-
	900	875-905	845-875	700	C23805	
	1000	975-1005	945-975	800	C23806	856,-

Made-to-measure

Height	Model	Width B	Product no.	Base price
1400-2000	Standard made-to-measure	500-1600	C23880	982,-

Adjustment range = dimensions - 15mm / + 15mm

Extras

Height	Profile	Product no.	Price
1900	Extension profile, 15mm	178002	32,-
2000	Extension profile, 15mm		

Colours - Panel options

Profile colours	Colour code	Extra charges	Panel options		without Anti-Plaque		with Anti-Plaque	
			Glass code	Extra charges	Glass code	Extra charges		
White	055	0,-	Clear	321	0,-	322	209,-	
Silver high-gloss	069		Privatima	373	186,-	375	395,-	
Matt silver	087							

HÜPPE Classics 2 Rectangular

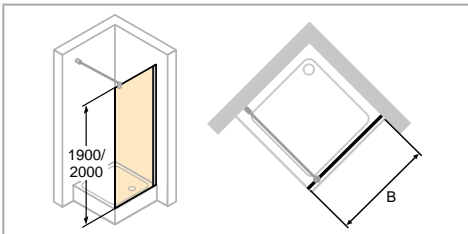

- Cannot be ordered as a free-standing side panel.
- Towel rail height can be selected individually and must be specified with the order. If nothing is specified, the towel rail is always delivered middle of glass (height and width).

Dimensions

WL: 25
R: 15
Mx: M+15
MG: 30

WEM = Tray installation dim. (000)
M = installation dimension Centre glass (001)
Please always specify when ordering.

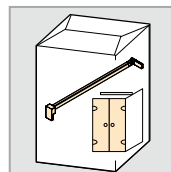
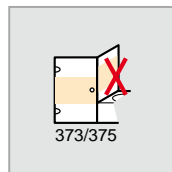
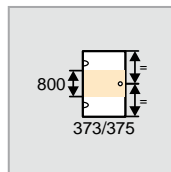
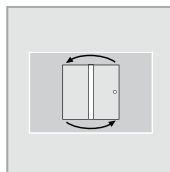
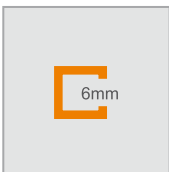

Side panel for two-way door

Height	Model	WEM B	M (middle of glass) B	Product no.	Base price
1900	SW 700	685-700	655-670	C23901	442,-
	SW 750	735-750	705-720	C23902	
	SW 800	785-800	755-770	C23903	
	SW 900	885-900	855-870	C23904	454,-
	SW 1000	985-1000	955-970	C23905	
2000	SW 700	685-700	655-670	C23906	486,-
	SW 750	735-750	705-720	C23907	
	SW 800	785-800	755-770	C23908	
	SW 900	885-900	855-870	C23909	501,-
	SW 1000	985-1000	955-970	C23910	

Made-to-measure

Height	Model	Width B	Product no.	Base price
500-2000	Standard made-to-measure	200-1200	C23980	574,-
	On bathtub (only with door in recess)	200-1200	C23981	

Adjustment range = dimensions - 8mm / + 7mm

Slopes and cut-outs

Slopes and cut-outs	Extra charges
 Supplement per slope/cut-out for made-to-measure	170,-

Special options

Optional variants		Extra charges
Towel rail (silver high-gloss)	T99	210,-

Colours - Panel options

Profile colours	Colour code	Extra charges	Panel options		without Anti-Plaque		with Anti-Plaque	
			Glass code	Extra charges	Glass code	Extra charges		
White	055	0,-	Clear	321	0,-	322	209,-	
Silver high-gloss	069		Privatima	373	186,-	375	395,-	
Matt silver	087							

HÜPPE Classics 2 Rectangular

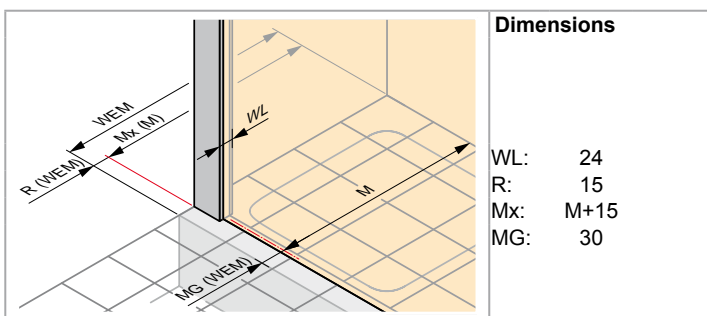
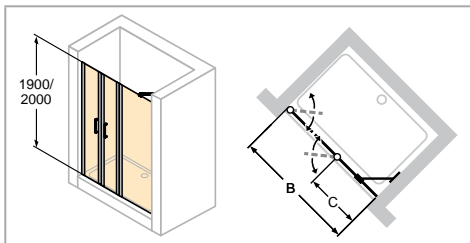

WEM = Tray installation dim. (000)
 M = installation dimension Centre glass (001)
 Please always specify when ordering.

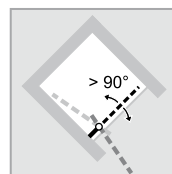
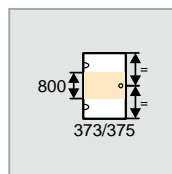
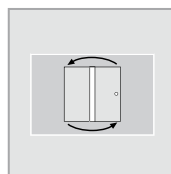
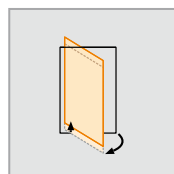
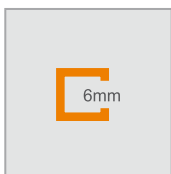

Two-way with additional section in recess

Height	Model	WEM B	M (middle of glass) B	Width C	Entry width	Product no.	Base price
1900	1200	1180-1205	1180-1205	392-407	750	C24601	1.059,-
	1400	1380-1405	1380-1405	392-407	950	C24602	1.091,-
	1600	1580-1605	1580-1605	592-607	950	C24603	
	1800	1780-1805	1780-1805	792-807	950	C24604	1.309,-
2000	1200	1180-1205	1180-1205	392-407	750	C24605	1.162,-
	1400	1380-1405	1380-1405	392-407	950	C24606	1.198,-
	1600	1580-1605	1580-1605	592-607	950	C24607	
	1800	1780-1805	1780-1805	792-807	950	C24608	1.438,-

Made-to-measure

Height	Width B	Product no.	Base price
1400-2000	1000-1600	C24680	1.309,-
	1601-2000	C24681	1.570,-

Adjustment range = dimensions - 13mm / + 12mm

Min. width of additional section: 230mm.

The width of the additional section must be stated.

Slopes and cut-outs

Slopes and cut-outs	Extra charges
	Supplement per slope/cut-out for made-to-measure 170,-

Extras

Height	Profile	Product no.	Price
1900		178002	32,-
2000		178006	

Colours - Panel options

Profile colours	Colour code	Extra charges	Panel options		without Anti-Plaque		with Anti-Plaque	
			Glass code	Extra charges	Glass code	Extra charges		
White	055	0,-	Clear	321	0,-	322	209,-	
Silver high-gloss	069		Privatima	373	186,-	375	395,-	
Matt silver	087							

HÜPPE Classics 2 Quadrant

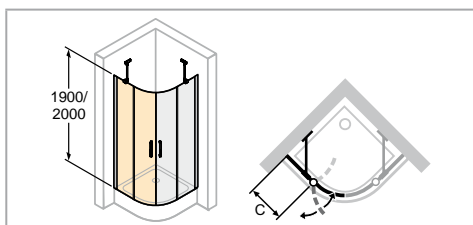

Dimensions	
WL:	25
R:	15
Mx:	M+15
MG:	30

WEM = Tray installation dim. (000)
M = installation dimension Centre glass (001)
Please always specify when ordering.

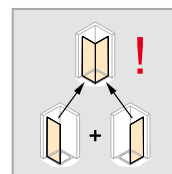
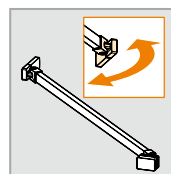
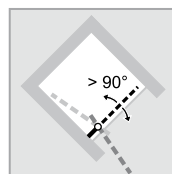
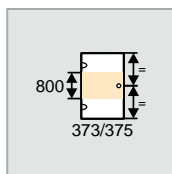
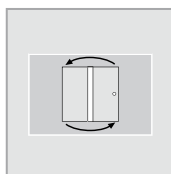
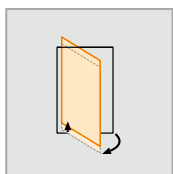
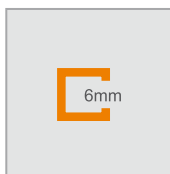

Swing door with fixed segments, 2-panel (1/2)

Height	Model	WEM	M (middle of glass)	Entry width	Width C	Radius	Product no.	Base price	
1900	800	785-800	755-770	630	280-295	500	C24001	651,-	
	900	885-900	855-870	630	380-395	500	C24002		
	1000	985-1000	955-970	630	480-495	500	C24003		
	2000	800	785-800	755-770	685	235-250	550	C24007	651,-
		900	885-900	855-870	685	335-350	550	C24008	
		1000	985-1000	955-970	685	435-450	550	C24009	
2000		800	785-800	755-770	630	280-295	500	C24004	715,-
		900	885-900	855-870	630	380-395	500	C24005	
		1000	985-1000	955-970	630	480-495	500	C24006	
	2000	800	785-800	755-770	685	235-250	550	C24010	715,-
		900	885-900	855-870	685	335-350	550	C24011	
		1000	985-1000	955-970	685	435-450	550	C24012	

NOTE: Price, item no. per panel. Complete unit consists of two item nos.

Asymmetric combinations with HÜPPE Purano (radius 500) and third-party trays possible.

Made-to-measure

Height	Width	Width C	Radius	Product no.	Base price
1900/2000	735-1135	200-600	500	C24080	847,-
	735-1135	200-600	550	C24081	

Made-to-measure available for width only

Adjustment range = dimensions - 8mm / + 7mm

Slopes and cut-outs

Slopes and cut-outs	Extra charges
	Supplement per slope/cut-out for made-to-measure 170,-

Extras

Height	Profile	Product no.	Price
1900	Extension profile, 15mm	178003	32,-
2000	Extension profile, 15mm	178007	

Colours - Panel options

Profile colours	Colour code	Extra charges	Panel options		without Anti-Plaque		with Anti-Plaque	
			Glass code	Extra charges	Glass code	Extra charges		
White	055	0,-	Clear	321	0,-	322	209,-	
Silver high-gloss	069		Privatima	373	186,-	375	395,-	
Matt silver	087							

HÜPPE Classics 2 Rectangular

Swing door, rectangular U-shaped enclosure

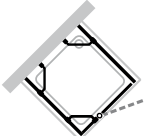
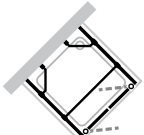
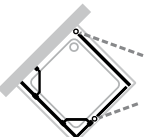
Height	Width	Consisting of:	For ...	Product no.	Price
1400-2000 1400-2000	700-1200 200-1200	1 swing door with fixed segment 2 side panels 1 extension kit for U-shaped enclosure		C24180	1.880,-
1400-2000 1400-2000	600-1100 200-1200	1 two-way door 2 side panels 1 extension kit for U-shaped enclosure		C24480	1.956,-
1400-2000 1400-2000 1400-2000	700-1200 500-1100 200-1200	1 swing door with fixed segment 1 swing door 1 side panel 1 extension kit for U-shaped enclosure		C24280	2.115,-

It must be stated whether the specified dimensions refer to the tray installation dimensions or the middle glass installation dimensions (e.g. floor-flush).
 The following therefore needs to be specified in the order with respect to dimensions:
 Refers to the tray installation dimensions: 000
 Refers to the middle glass installation dimensions: 001

Colours - Panel options

Profile colours	Colour code	Extra charges
White	055	0,-
Silver high-gloss	069	
Matt silver	087	

Panel options	without Anti-Plaque		with Anti-Plaque	
	Glass code	Extra charges	Glass code	Extra charges
Clear	321	0,-	322	418,-

HÜPPE Aura elegance model overview - Base price

Rectangular

Sliding door, 2-section corner entry

Sliding door, 1-panel with fixed segment

Side panel for sliding door 1-panel with fixed segment

Sliding door with fixed segment and additional section

Sliding door, 2-panel with fixed segments

Side panel for sliding door 2-panel with fixed segments/Sliding door with fixed segment and additional section

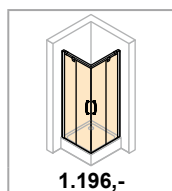

F.6-F.7

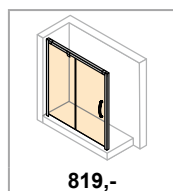

F.8-F.11

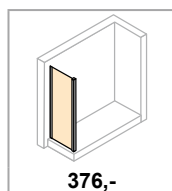

F.12-F.13

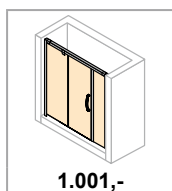

F.14-F.15

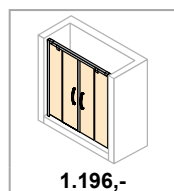

F.16-F.17

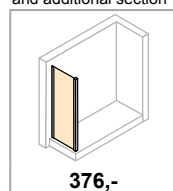

F.18-F.19

Quadrant

Sliding door

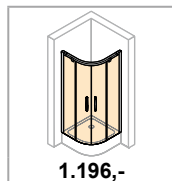

F.20-F.21

Rectangular

Swing door corner entry with fixed segments

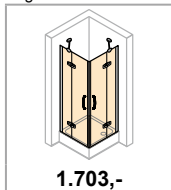

1.703,-

F.22-F.23

Swing door with fixed segment in recess

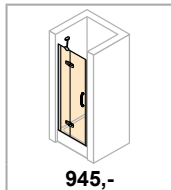

945,-

F.24-F.25

Swing door with fixed segment for side panel/corner entry

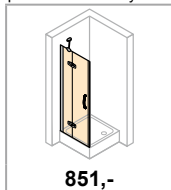

851,-

F.26-F.29

Side panel

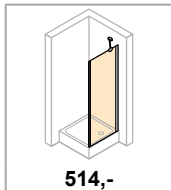

514,-

F.30-F.31

Quadrant

Swing door with fixed segments, 2-panel

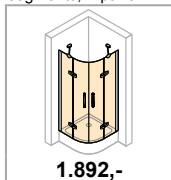

1.892,-

F.32-F.33

Pentagonal

Swing door with fixed segments, 1-panel

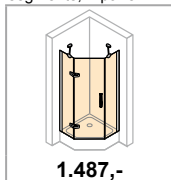

1.487,-

F.34-F.35

HÜPPE Aura elegance sliding doors



HÜPPE Aura elegance swing doors



Product details

Sliding doors



Handle



Easy release mechanism at the base of the door for easy cleaning in between the fixed panel and door panel.



The transparent sliding doors of the HÜPPE Aura elegance series close independently thanks to the optional Soft-Open/Soft-Close mechanism.



Corner connectors, holders, caps, handle and drip deflector strips are always in chrome or high-gloss silver

High-quality chrome applications provide the systems in silver matt and white with a modern bi-colour design:



Matt silver design



White design



High-gloss silver design

All sliding door models of the HÜPPE Aura elegance series can be optionally installed with a drip deflector strip for optimum tightness or as easy access units.

Product details Swing doors



Rise and fall mechanism on the hinge provides easy operation and a smooth door closure.
Stabilizer, hinges and handle always in chrome, drip deflector strip always in high-gloss silver.



Handle with pleasant feel

HÜPPE Aura elegance Rectangular

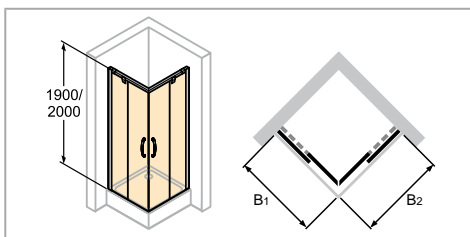

Dimensions	
WL:	23
R:	15
Mx:	M+10
MG:	25

WEM = Tray installation dim. (000)
M = installation dimension Centre glass (001)
Please always specify when ordering.

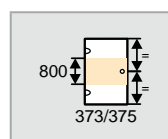
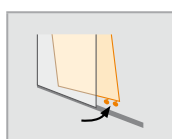
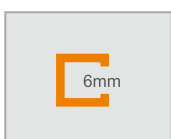

Sliding door, 2-section corner entry

Height	Model	WEM B1	WEM B2	M (middle of glass) B1	M (middle of glass) B2	Entry width	Product no.	Base price
1900	800x800	785-805	785-805	760-780	760-780	380-410	401301	1.196,-
	900x900	885-905	885-905	860-880	860-880	450-480	401302	
	1000x1000	985-1005	985-1005	960-980	960-980	520-550	401303	1.242,-
	750x900	735-755	885-905	710-730	860-880	400-430	401304	1.196,-
	800x1200	785-805	1185-1205	760-780	1160-1180	520-550	401306	1.269,-
	900x750	885-905	735-755	860-880	710-730	400-430	401305	1.196,-
	1200x800	1185-1205	785-805	1160-1180	760-780	520-550	401307	1.269,-
2000	800x800	785-805	785-805	760-780	760-780	380-410	401308	1.316,-
	900x900	885-905	885-905	860-880	860-880	450-480	401309	
	1000x1000	985-1005	985-1005	960-980	960-980	520-550	401310	1.368,-
	750x900	735-755	885-905	710-730	860-880	400-430	401311	1.316,-
	800x1200	785-805	1185-1205	760-780	1160-1180	520-550	401313	1.395,-
	900x750	885-905	735-755	860-880	710-730	400-430	401312	1.316,-
	1200x800	1185-1205	785-805	1160-1180	760-780	520-550	401314	1.395,-

Made-to-measure

Height	Width B1	Width B2	Product no.	Base price
1200-2000	700-1300	700-1300	401380	1.554,-

Adjustment range = dimensions - 10mm / + 10mm

Asymmetric solutions: Miniature dimension 655mm only if the side has a width of at least 805mm.

Dim. Range: min. - max.

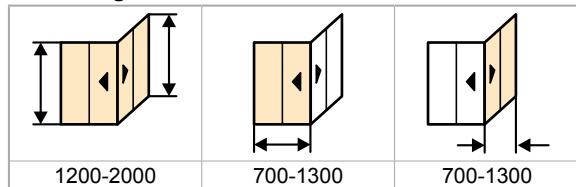

Special options

Optional variants		Extra charges
Soft-Open-/Soft-Close-function	730	138,-

Colours - Panel options

Profile colours	Colour code	Extra charges	Panel options		without Anti-Plaque		with Anti-Plaque	
			Glass code	Extra charges	Glass code	Extra charges		
White	055	0,-	Clear	321	0,-	322	418,-	
Matt silver	087		Sand Plus	315	371,-	316	789,-	
Silver high-gloss	092		Privatima	373		375		

HÜPPE Aura elegance Rectangular

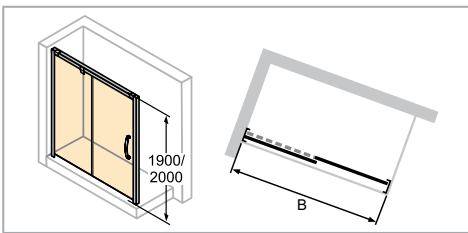

Dimensions	
WL:	23
R:	15
Mx:	M+10
MG:	25

WEM = Tray installation dim. (000)
M = installation dimension Centre glass (001)
Please always specify when ordering.

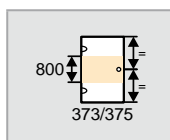
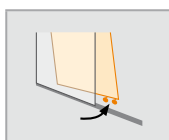
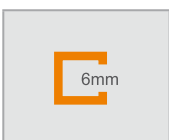

Sliding door, 1-panel with fixed segment

Left-hand fixing

Height	Model	WEM In recess	WEM Side panel	M (middle of glass) Recess	M (middle of glass) Side panel	Entry width	Product no.	Base price
1900	900	860-900	890-930	860-900	872-912	330-370	401401	819,-
	1000	960-1000	990-1030	960-1000	972-1012	380-420	401402	852,-
	1100	1060-1100	1090-1130	1060-1100	1072-1112	430-470	401403	
	1200	1160-1200	1190-1230	1160-1200	1172-1212	480-520	401404	867,-
	1300	1260-1300	1290-1330	1260-1300	1272-1312	530-570	401405	
	1400	1360-1400	1390-1430	1360-1400	1372-1412	580-620	401406	
	1500	1460-1500	1490-1530	1460-1500	1472-1512	630-670	401407	
	1600	1560-1600	1590-1630	1560-1600	1572-1612	680-720	401408	
	1700	1660-1700	1690-1730	1660-1700	1672-1712	730-770	401409	
1800	1760-1800	1790-1830	1760-1800	1772-1812	780-820	401410		
2000	900	860-900	890-930	860-900	872-912	330-370	401411	901,-
	1000	960-1000	990-1030	960-1000	972-1012	380-420	401412	937,-
	1100	1060-1100	1090-1130	1060-1100	1072-1112	430-470	401413	
	1200	1160-1200	1190-1230	1160-1200	1172-1212	480-520	401414	954,-
	1300	1260-1300	1290-1330	1260-1300	1272-1312	530-570	401415	
	1400	1360-1400	1390-1430	1360-1400	1372-1412	580-620	401416	
	1500	1460-1500	1490-1530	1460-1500	1472-1512	630-670	401417	
	1600	1560-1600	1590-1630	1560-1600	1572-1612	680-720	401418	
	1700	1660-1700	1690-1730	1660-1700	1672-1712	730-770	401419	
1800	1760-1800	1790-1830	1760-1800	1772-1812	780-820	401420		

Made-to-measure - Left-hand fixing

Height	Model	Width B	Product no.	Base price
1200-2000	In recess	900-2000	401480	1.064,-
	For side panel	900-2000	401481	

Adjustment range = dimensions - 20mm / + 20mm

Dim. Range: min. - max.

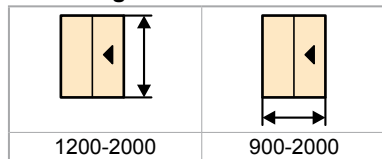

Special options

Optional variants		Extra charges
Soft-Open-/Soft-Close-function	730	69,-

Colours - Panel options

Profile colours	Colour code	Extra charges	Panel options		without Anti-Plaque		with Anti-Plaque	
			Glass code	Extra charges	Glass code	Extra charges		
White	055	0,-	Clear	321	0,-	322	209,-	
Matt silver	087		Sand Plus	315	186,-	316	395,-	
Silver high-gloss	092	156,-	Privatima	373		375		

HÜPPE Aura elegance Rectangular

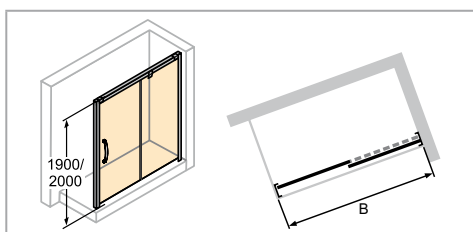

Dimensions	
WL:	23
R:	15
Mx:	M+10
MG:	25

WEM = Tray installation dim. (000)
M = installation dimension Centre glass (001)
Please always specify when ordering.

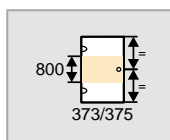
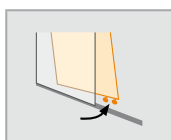
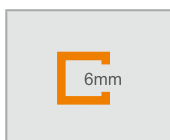

Sliding door, 1-panel with fixed segment

Right-hand fixing

Height	Model	WEM In recess	WEM Side panel	M (middle of glass) Recess	M (middle of glass) Side panel	Entry width	Product no.	Base price
1900	900	860-900	890-930	860-900	872-912	330-370	401501	819,-
	1000	960-1000	990-1030	960-1000	972-1012	380-420	401502	852,-
	1100	1060-1100	1090-1130	1060-1100	1072-1112	430-470	401503	
	1200	1160-1200	1190-1230	1160-1200	1172-1212	480-520	401504	867,-
	1300	1260-1300	1290-1330	1260-1300	1272-1312	530-570	401505	
	1400	1360-1400	1390-1430	1360-1400	1372-1412	580-620	401506	
	1500	1460-1500	1490-1530	1460-1500	1472-1512	630-670	401507	
	1600	1560-1600	1590-1630	1560-1600	1572-1612	680-720	401508	
	1700	1660-1700	1690-1730	1660-1700	1672-1712	730-770	401509	
1800	1760-1800	1790-1830	1760-1800	1772-1812	780-820	401510		
2000	900	860-900	890-930	860-900	872-912	330-370	401511	901,-
	1000	960-1000	990-1030	960-1000	972-1012	380-420	401512	937,-
	1100	1060-1100	1090-1130	1060-1100	1072-1112	430-470	401513	
	1200	1160-1200	1190-1230	1160-1200	1172-1212	480-520	401514	954,-
	1300	1260-1300	1290-1330	1260-1300	1272-1312	530-570	401515	
	1400	1360-1400	1390-1430	1360-1400	1372-1412	580-620	401516	
	1500	1460-1500	1490-1530	1460-1500	1472-1512	630-670	401517	
	1600	1560-1600	1590-1630	1560-1600	1572-1612	680-720	401518	
	1700	1660-1700	1690-1730	1660-1700	1672-1712	730-770	401519	
1800	1760-1800	1790-1830	1760-1800	1772-1812	780-820	401520		

Made-to-measure - Right-hand fixing

Height	Model	Width B	Product no.	Base price
1200-2000	In recess	900-2000	401580	1.064,-
	For side panel	900-2000	401581	

Adjustment range = dimensions - 20mm / + 20mm

Dim. Range: min. - max.

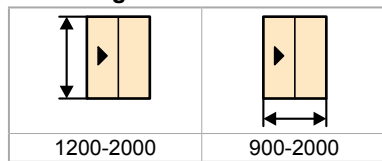

Special options

Optional variants		Extra charges
Soft-Open-/Soft-Close-function	730	69,-

Colours - Panel options

Profile colours	Colour code	Extra charges	Panel options	without Anti-Plaque		with Anti-Plaque	
				Glass code	Extra charges	Glass code	Extra charges
White	055	0,-	Clear	321	0,-	322	209,-
Matt silver	087		Sand Plus	315	186,-	316	395,-
Silver high-gloss	092		Privatima	373		375	

HÜPPE Aura elegance Rectangular

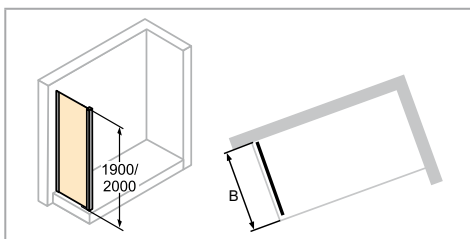

- Towel rail height can be selected individually and must be specified with the order. If nothing is specified, the towel rail is always delivered middle of glass (height and width).

Dimensions	
	<p>WL: 23</p> <p>R: 8</p> <p>Mx: M+10</p> <p>MG: 18</p>
<p>WEM = Tray installation dim. (000)</p> <p>M = installation dimension Centre glass (001)</p> <p>Please always specify when ordering.</p>	

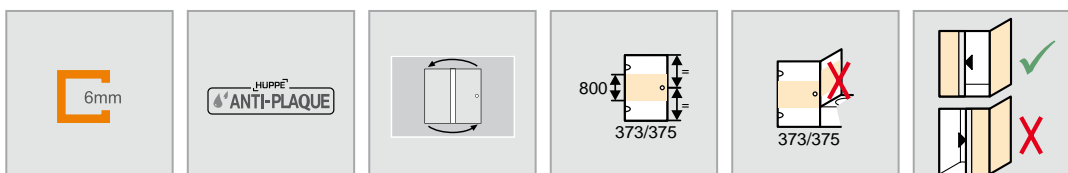

Side panel for sliding door 1-panel with fixed segment

Height	Model	WEM	M (middle of glass)	Product no.	Base price
1900	SW 750	735-755	710-730	401601	376,-
	SW 800	785-805	760-780	401602	
	SW 900	885-905	860-880	401603	
	SW 1000	985-1005	960-980	401604	392,-
2000	SW 750	735-755	710-730	401605	415,-
	SW 800	785-805	760-780	401606	
	SW 900	885-905	860-880	401607	
	SW 1000	985-1005	960-980	401608	429,-

Made-to-measure

Height	Model	Width B	Product no.	Base price
500-2000	Standard made-to-measure	200-1200	401680	489,-
	On bathtub	200-1200	401681	
	In-line configuration	200-1200	401682	

Adjustment range = dimensions - 10mm / + 10mm

Slopes and cut-outs

Slopes and cut-outs	Extra charges
 Supplement per slope/cut-out for made-to-measure	170,-

Dim. Range: min. - max.

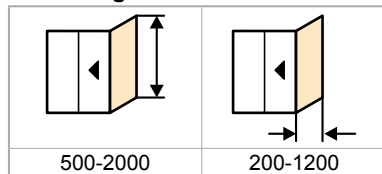

Special options

Optional variants	Product no.	Extra charges
Towel rail (silver high-gloss)	T99	210,-

Colours - Panel options

Profile colours	Colour code	Extra charges	Panel options		without Anti-Plaque		with Anti-Plaque	
			Glass code	Extra charges	Glass code	Extra charges		
White	055	0,-	Clear	321	0,-	322	209,-	
Matt silver	087	0,-	Sand Plus	315	186,-	316	395,-	
Silver high-gloss	092	114,-	Privatima	373		375		

HÜPPE Aura elegance Rectangular

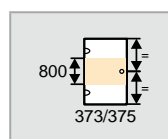
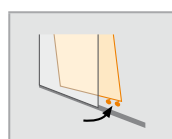
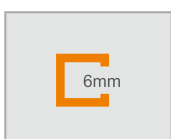
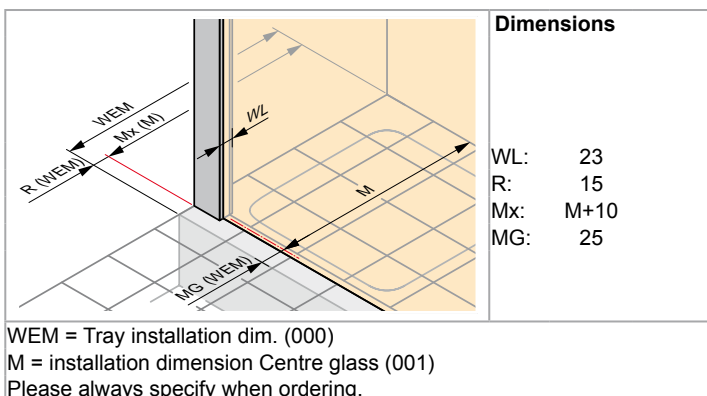
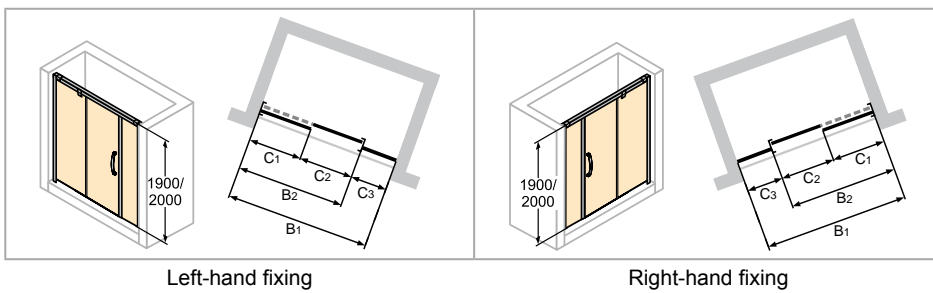

Sliding door with fixed segment and additional section

Left-hand fixing

Height	Model	WEM In recess/SWK	WEM Side panel	M (middle of glass) Recess/SWK	M (middle of glass) Side panel	Width C1	Width C2	Width C3	Product no.	Base price
1900	1600	1560-1600	1590-1630	1560-1600	1572-1612	670-685	575-615	211-226	401801	1.001,-
	1700	1660-1700	1690-1730	1660-1700	1672-1712	720-735	625-665	211-226	401802	
	1800	1760-1800	1790-1830	1760-1800	1772-1812	770-785	675-715	211-226	401803	
2000	1600	1560-1600	1590-1630	1560-1600	1572-1612	670-685	575-615	211-226	401804	1.100,-
	1700	1660-1700	1690-1730	1660-1700	1672-1712	720-735	625-665	211-226	401805	
	1800	1760-1800	1790-1830	1760-1800	1772-1812	770-785	675-715	211-226	401806	

Made-to-measure - Left-hand fixing

Height	Model	Width B1	Width B2	Additional section width C3	Product no.	Base price
1200-2000	In recess	1200-1800	1000-1600	200-1200	401880	1.301,-
	In recess	1801-2400	1000-2200	200-1200	40188A	1.694,-
	For side panel	1200-1800	1000-1600	200-1200	401881	1.301,-
	For side panel	1801-2400	1000-2200	200-1200	40188B	1.694,-

Adjustment range = dimensions - 20mm / + 20mm

Right-hand fixing





Height	Model	WEM In recess/SWK	WEM Side panel	M (middle of glass) Recess/SWK	M (middle of glass) Side panel	Width C1	Width C2	Width C3	Product no.	Base price
1900	1600	1560-1600	1590-1630	1560-1600	1572-1612	670-685	575-615	211-226	401901	1.001,-
	1700	1660-1700	1690-1730	1660-1700	1672-1712	720-735	625-665	211-226	401902	
	1800	1760-1800	1790-1830	1760-1800	1772-1812	770-785	675-715	211-226	401903	
2000	1600	1560-1600	1590-1630	1560-1600	1572-1612	670-685	575-615	211-226	401904	1.100,-
	1700	1660-1700	1690-1730	1660-1700	1672-1712	720-735	625-665	211-226	401905	
	1800	1760-1800	1790-1830	1760-1800	1772-1812	770-785	675-715	211-226	401906	

Made-to-measure - Right-hand fixing

Height	Model	Width B1	Width B2	Additional section width C3	Product no.	Base price
1200-2000	In recess	1200-1800	1000-1600	200-1200	401980	1.301,-
	In recess	1801-2400	1000-2200	200-1200	40198A	1.694,-
	For side panel	1200-1800	1000-1600	200-1200	401981	1.301,-
	For side panel	1801-2400	1000-2200	200-1200	40198B	1.694,-

Adjustment range = dimensions - 20mm / + 20mm

Dim. Range: min. - max.

			
1200-2000	1200-2400	1000-2200	200-1200

Special options

Optional variants		Extra charges
Soft-Open-/Soft-Close-function	730	69,-

Colours - Panel options

Profile colours	Colour code	Extra charges	Panel options	without Anti-Plaque		with Anti-Plaque	
				Glass code	Extra charges	Glass code	Extra charges
White	055	0,-	Clear	321	0,-	322	418,-
Matt silver	087		Sand Plus	315	371,-	316	789,-
Silver high-gloss	092	312,-	Privatima	373		375	

HÜPPE Aura elegance Rectangular

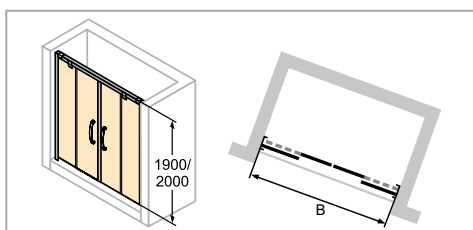

Dimensions	
WL:	23
R:	15
Mx:	M+10
MG:	25

WEM = Tray installation dim. (000)
M = installation dimension Centre glass (001)
Please always specify when ordering.

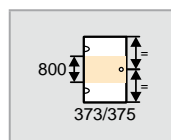
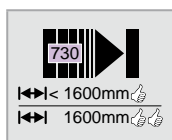
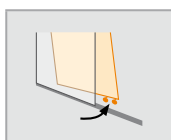
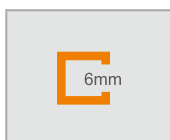

Sliding door, 2-panel with fixed segments



Height	Model	WEM In recess/SWK	WEM Side panel	M (middle of glass) Recess/SWK	M (middle of glass) Side panel	Entry width	Product no.	Base price
1900	1600	1560-1600	1590-1630	1560-1600	1572-1612	610-650	402101	1.196,-
	1700	1660-1700	1690-1730	1660-1700	1672-1712	660-700	402102	
	1800	1760-1800	1790-1830	1760-1800	1772-1812	710-750	402103	
2000	1600	1560-1600	1590-1630	1560-1600	1572-1612	610-650	402104	1.316,-
	1700	1660-1700	1690-1730	1660-1700	1672-1712	660-700	402105	
	1800	1760-1800	1790-1830	1760-1800	1772-1812	710-750	402106	

Made-to-measure

Height	Model	Width B	Product no.	Base price
1200-2000	In recess	1200-1800	402180	1.554,-
	In recess	1801-2200	40218A	1.948,-
	For side panel	1200-1800	402181	1.554,-
	For side panel	1801-2200	40218B	1.948,-

Adjustment range = dimensions - 20mm / + 20mm

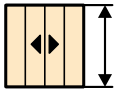
Dim. Range: min. - max.

	
1200-2000	1200-2200

Special options

Optional variants		Extra charges
Soft-Open-/Soft-Close-function	730	138,-

Colours - Panel options

Profile colours	Colour code	Extra charges	Panel options		without Anti-Plaque		with Anti-Plaque	
			Glass code	Extra charges	Glass code	Extra charges		
White	055	0,-	Clear	321	0,-	322	418,-	
Matt silver	087		Sand Plus	315	371,-	316	789,-	
Silver high-gloss	092	312,-	Privatima	373		375		

HÜPPE Aura elegance Rectangular

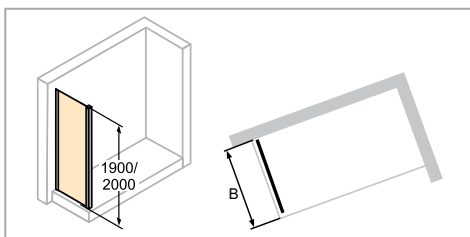

- Towel rail height can be selected individually and must be specified with the order. If nothing is specified, the towel rail is always delivered middle of glass (height and width).

Dimensions	
	<p>WL: 23 R: 8 Mx: M+10 MG: 18</p>
<p>WEM = Tray installation dim. (000) M = installation dimension Centre glass (001) Please always specify when ordering.</p>	

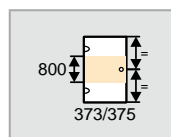
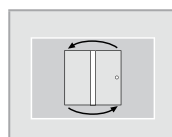
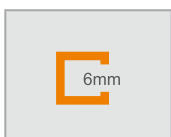

Side panel for sliding door 2-panel with fixed segments/Sliding door with fixed segment and additional section

Height	Model	WEM	M (middle of glass)	Product no.	Base price
1900	SW 750	735-755	710-730	402201	376,-
	SW 800	785-805	760-780	402202	
	SW 900	885-905	860-880	402203	
	SW 1000	985-1005	960-980	402204	392,-
2000	SW 750	735-755	710-730	402205	415,-
	SW 800	785-805	760-780	402206	
	SW 900	885-905	860-880	402207	429,-
	SW 1000	985-1005	960-980	402208	

Made-to-measure

Height	Model	Width B	Product no.	Base price
1200-2000	Standard made-to-measure	200-1200	402280	489,-
	On bathtub	200-1200	402281	
	In-line configuration	200-1200	402282	

Adjustment range = dimensions - 10mm / + 10mm

Slopes and cut-outs

Slopes and cut-outs	Extra charges
 Supplement per slope/cut-out for made-to-measure	170,-

Dim. Range: min. - max.

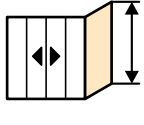
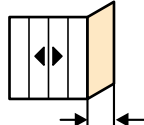
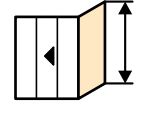
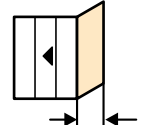
			
1200-2000	200-1200	1200-2000	200-1200

Special options

Optional variants		Extra charges
Towel rail (silver high-gloss)	T99	210,-

Colours - Panel options

Profile colours	Colour code	Extra charges	Panel options		without Anti-Plaque		with Anti-Plaque	
			Glass code	Extra charges	Glass code	Extra charges		
White	055	0,-	Clear	321	0,-	322	209,-	
Matt silver	087		Sand Plus	315	186,-	316	395,-	
Silver high-gloss	092	114,-	Privatima	373		375		

HÜPPE Aura elegance Quadrant

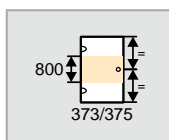
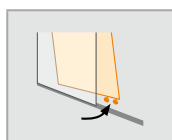
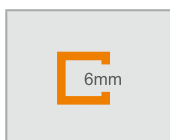
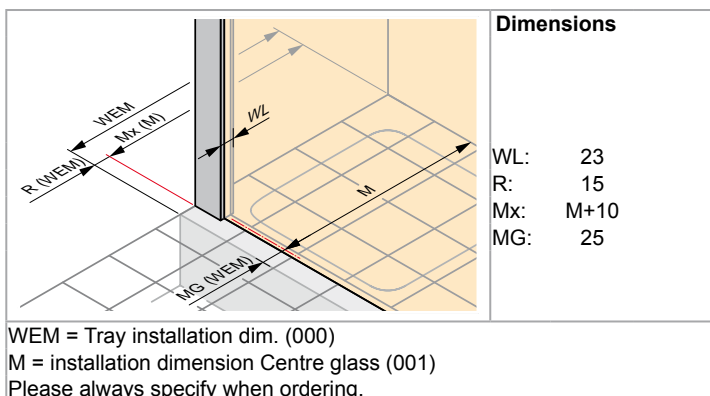
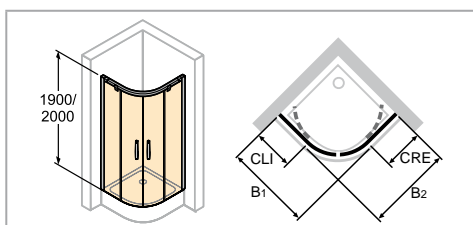

Sliding door

Height	Model B1/B2	WEM B1	WEM B2	M (middle of glass) B1	M (middle of glass) B2	CLI	CRE	Entry width	Radius	Product no.	Base price	
1900	800 x 800	785-805	785-805	760-780	760-780	300-320	300-320	465	500	402401	1.196,-	
	900 x 900	885-905	885-905	860-880	860-880	400-420	400-420	465	500	402402		
	1000 x 1000	985-1005	985-1005	960-980	960-980	500-520	500-520	465	500	402403		1.242,-
	1200 x 1200	1185-1205	1185-1205	1160-1180	1160-1180	700-720	700-720	465	500	402404		1.269,-
	750 x 900	735-755	885-905	710-730	860-880	250-270	400-420	465	500	402405		1.196,-
	900 x 750	885-905	735-755	860-880	710-730	400-420	250-270	465	500	402406		
	800 x 900	785-805	885-905	760-780	860-880	300-320	400-420	465	500	402407		
	900 x 800	885-905	785-805	860-880	760-780	400-420	300-320	465	500	402408		
	800 x 1000	785-805	985-1005	760-780	960-980	300-320	500-520	465	500	402409		1.242,-
	1000 x 800	985-1005	785-805	960-980	760-780	500-520	300-320	465	500	402410		
	800 x 1200	785-805	1185-1205	760-780	1160-1180	300-320	700-720	465	500	402413		1.269,-
	1200 x 800	1185-1205	785-805	1160-1180	760-780	700-720	300-320	465	500	402414		
	900 x 1000	885-905	985-1005	860-880	960-980	400-420	500-520	465	500	402411		1.242,-
	1000 x 900	985-1005	885-905	960-980	860-880	500-520	400-420	465	500	402412		
	900 x 1200	885-905	1185-1205	860-880	1160-1180	400-420	700-720	465	500	402415		1.269,-
	1200 x 900	1185-1205	885-905	1160-1180	860-880	700-720	400-420	465	500	402416		
	800 x 800	785-805	785-805	760-780	760-780	255-275	255-275	445	550	402417		1.196,-
	900 x 900	885-905	885-905	860-880	860-880	355-375	355-375	510	550	402418		
	1000 x 1000	985-1005	985-1005	960-980	960-980	455-475	455-475	510	550	402419		1.242,-
	1200 x 1200	1185-1205	1185-1205	1160-1180	1160-1180	655-675	655-675	510	550	402420		1.269,-
2000	800 x 800	785-805	785-805	760-780	760-780	300-320	300-320	465	500	402421	1.316,-	
	900 x 900	885-905	885-905	860-880	860-880	400-420	400-420	465	500	402422		
	1000 x 1000	985-1005	985-1005	960-980	960-980	500-520	500-520	465	500	402423		1.368,-
	1200 x 1200	1185-1205	1185-1205	1160-1180	1160-1180	700-720	700-720	465	500	402424		1.395,-
	750 x 900	735-755	885-905	710-730	860-880	250-270	400-420	465	500	402425		1.316,-
	900 x 750	885-905	735-755	860-880	710-730	400-420	250-270	465	500	402426		
	800 x 900	785-805	885-905	760-780	860-880	300-320	400-420	465	500	402427		
	900 x 800	885-905	785-805	860-880	760-780	400-420	300-320	465	500	402428		
	800 x 1000	785-805	985-1005	760-780	960-980	300-320	500-520	465	500	402429		1.368,-
	1000 x 800	985-1005	785-805	960-980	760-780	500-520	300-320	465	500	402430		
	800 x 1200	785-805	1185-1205	760-780	1160-1180	300-320	700-720	465	500	402433		1.395,-
	1200 x 800	1185-1205	785-805	1160-1180	760-780	700-720	300-320	465	500	402434		
	900 x 1000	885-905	985-1005	860-880	960-980	400-420	500-520	465	500	402431		1.368,-
	1000 x 900	985-1005	885-905	960-980	860-880	500-520	400-420	465	500	402432		
	900 x 1200	885-905	1185-1205	860-880	1160-1180	400-420	700-720	465	500	402435		1.395,-
	1200 x 900	1185-1205	885-905	1160-1180	860-880	700-720	400-420	465	500	402436		
	800 x 800	785-805	785-805	760-780	760-780	255-275	255-275	445	550	402437		1.316,-
	900 x 900	885-905	885-905	860-880	860-880	355-375	355-375	510	550	402438		
	1000 x 1000	985-1005	985-1005	960-980	960-980	455-475	455-475	510	550	402439		1.368,-
	1200 x 1200	1185-1205	1185-1205	1160-1180	1160-1180	655-675	655-675	510	550	402440		1.395,-

Made-to-measure

Height	Width B1	Width B2	CLI	CRE	Radius	Product no.	Base price
1900/2000	700-1195	700-1195	289-704	289-704	500	402480	1.554,-
	700-1195	700-1195	289-704	289-704	550	402481	

Made-to-measure available for width only

Adjustment range = dimensions - 10mm / + 10mm

Dim. Range: min. - max.

1900/2000	700-1195	700-1195	289-704	289-704

Colours - Panel options

Profile colours	Colour code	Extra charges	Panel options	without Anti-Plaque		with Anti-Plaque	
				Glass code	Extra charges	Glass code	Extra charges
White	055	0,-	Clear	321	0,-	322	418,-
Matt silver	087		Sand Plus	315	371,-	316	789,-
Silver high-gloss	092		Privatima	373		375	

HÜPPE Aura elegance Rectangular

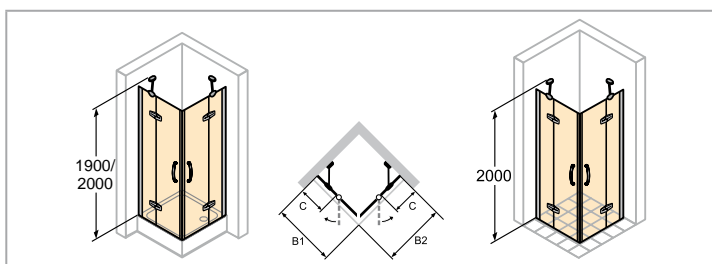

Dimensions	
WL:	25
R:	15
Mx:	M+15
MG:	30

WEM = Tray installation dim. (000)
M = installation dimension Centre glass (001)
Please always specify when ordering.

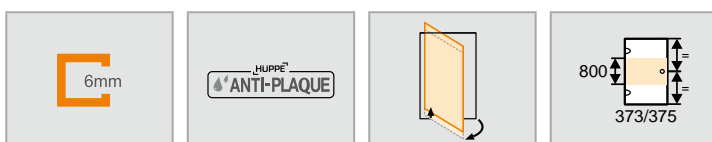

Swing door corner entry with fixed segments

Installation on shower tray recommended

Height	Model	WEM B1	WEM B2	M (middle of glass) B1	M (middle of glass) B2	Entry width	C1/C2	Product no.	Base price
1900	800x800	785-800	785-800	755-770	755-770	680	265-280	400501	1.703,-
	900x900	885-900	885-900	855-870	855-870	820	265-280	400502	
	1000x1000	985-1000	985-1000	955-970	955-970	960	265-280	400503	1.770,-
2000	800x800	785-800	785-800	755-770	755-770	680	265-280	400520	1.872,-
	900x900	885-900	885-900	855-870	855-870	820	265-280	400521	
	1000x1000	985-1000	985-1000	955-970	955-970	960	265-280	400522	1.948,-

Floor-flush installation recommended

Height	Model	M (middle of glass) B1	M (middle of glass) B2	Entry width	C1/C2	Product no.	Base price
2000	800x800	792-807	792-807	680	302-317	400512	1.872,-
	900x900	892-907	892-907	820	302-317	400513	
	1000x1000	992-1007	992-1007	960	302-317	400514	1.948,-

Made-to-measure

Height	Width B1	Width B2	Product no.	Base price
1600-2000	700-1200	700-1200	400580	2.213,-

Adjustment range = dimensions - 8mm / + 7mm

The widths of the fixed segments are defined by HÜPPE.

Dim. Range: min. - max.

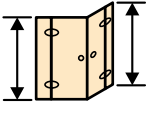
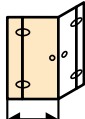
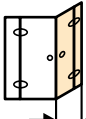
		
1600-2000	700-1200	700-1200

Extras

Height	Profile	Product no.	Price
1900	Extension profile, 15mm	178002	32,-
2000	Extension profile, 15mm	178006	

Colours - Panel options

Profile colours	Colour code	Extra charges	Panel options	without Anti-Plaque		with Anti-Plaque	
				Glass code	Extra charges	Glass code	Extra charges
White	055	0,-	Clear	321	0,-	322	418,-
Matt silver	087		Sand Plus	315	371,-	316	789,-
Silver high-gloss	092	312,-	Privatima	373		375	

HÜPPE Aura elegance Rectangular

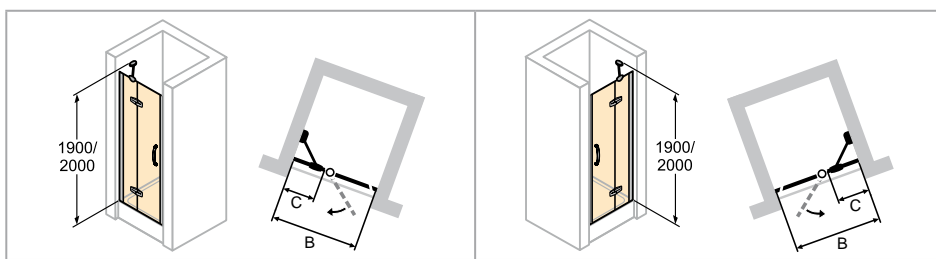

Left-hand fixing

Right-hand fixing

Dimensions	
WL:	25
R:	15
Mx:	M+15
MG:	30

WEM = Tray installation dim. (000)
M = installation dimension Centre glass (001)
Please always specify when ordering.

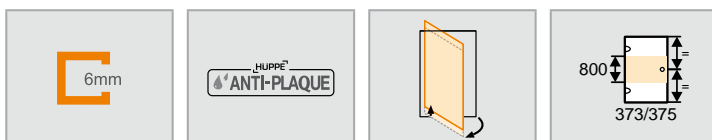

Swing door with fixed segment in recess

Left-hand fixing

Height	Model	WEM B	M (middle of glass) B	Entry width	Width of fixed segment C	Product no.	Base price
1900	800	785-805	785-805	472	265-280	400101	945,-
	900	885-905	885-905	572	265-280	400102	
	1000	985-1005	985-1005	672	265-280	400103	983,-
	1200	1185-1205	1185-1205	672	465-480	400107	1.003,-
2000	800	785-805	785-805	472	265-280	400104	1.041,-
	900	885-905	885-905	572	265-280	400105	
	1000	985-1005	985-1005	672	265-280	400106	1.081,-
	1200	1185-1205	1185-1205	672	465-480	400108	1.102,-

Made-to-measure - Left-hand fixing

Height	Width B	Product no.	Base price
1600-2000	700-1200	400180	1.231,-

Adjustment range = dimensions - 10mm / + 10mm

The widths of the fixed segments are defined by HÜPPE.

Right-hand fixing

Height	Model	WEM B	M (middle of glass) B	Entry width	Width of fixed segment C	Product no.	Base price
1900	800	785-805	785-805	472	265-280	400201	945,-
	900	885-905	885-905	572	265-280	400202	
	1000	985-1005	985-1005	672	265-280	400203	983,-
	1200	1185-1205	1185-1205	672	465-480	400207	1.003,-
2000	800	785-805	785-805	472	265-280	400204	1.041,-
	900	885-905	885-905	572	265-280	400205	
	1000	985-1005	985-1005	672	265-280	400206	1.081,-
	1200	1185-1205	1185-1205	672	465-480	400208	1.102,-

Made-to-measure - Right-hand fixing

Height	Width B	Product no.	Base price
1600-2000	700-1200	400280	1.231,-

Adjustment range = dimensions - 10mm / + 10mm

The widths of the fixed segments are defined by HÜPPE.

Dim. Range: min. - max.

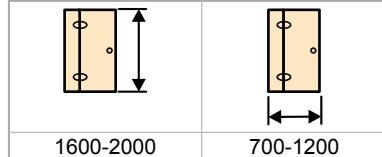

Extras

Height	Profile	Product no.	Price
1900	Extension profile, 15mm	178002	32,-
2000	Extension profile, 15mm		

Colours - Panel options

Profile colours	Colour code	Extra charges	Panel options	without Anti-Plaque		with Anti-Plaque	
				Glass code	Extra charges	Glass code	Extra charges
White	055	0,-	Clear	321	0,-	322	209,-
Matt silver	087		Sand Plus	315	186,-	316	395,-
Silver high-gloss	092		Privatima	373		375	

HÜPPE Aura elegance Rectangular

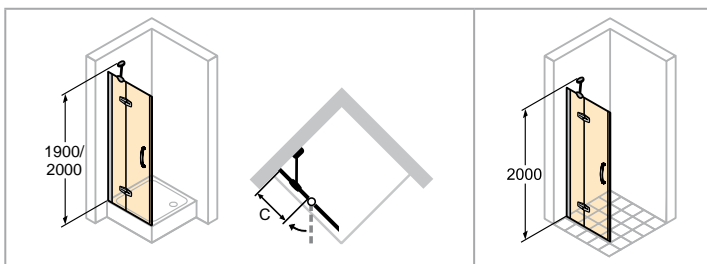

Left-hand fixing

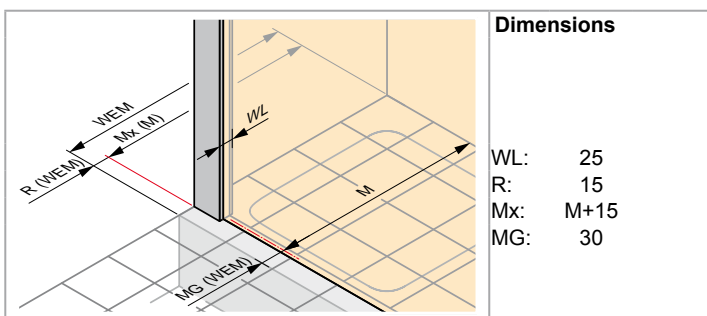

Dimensions

- WL: 25
- R: 15
- Mx: M+15
- MG: 30

WEM = Tray installation dim. (000)
 M = installation dimension Centre glass (001)
 Please always specify when ordering.

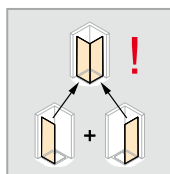
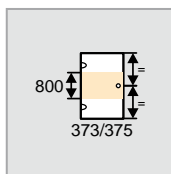
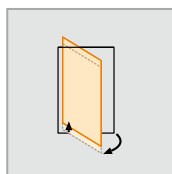
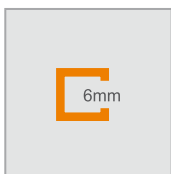

Swing door with fixed segment for side panel/corner entry

Left-hand fixing

Installation on shower tray recommended

Height	Model	WEM	M (middle of glass)	Entry width STS	Entry width STE	Width of fixed segment C	Product no.	Base price
1900	750	735-750	705-720	372	540	315-330	400304	851,-
	800	785-800	755-770	472	680	265-280	400301	
	900	885-900	855-870	572	820	265-280	400302	
	1000	985-1000	955-970	672	960	265-280	400303	887,-
	1200	1185-1200	1155-1170	672	965	465-480	400305	902,-
2000	750	735-750	705-720	372	540	315-330	400311	937,-
	800	785-800	755-770	472	680	265-280	400312	
	900	885-900	855-870	572	820	265-280	400313	
	1000	985-1000	955-970	672	960	265-280	400314	975,-
	1200	1185-1200	1155-1170	672	965	465-480	400315	992,-

NOTE: Complete corner entry consisting of two item no. Right door see next page.

Left-hand fixing

Floor-flush installation recommended

Height	Model	M (middle of glass)	Entry width STS	Entry width STE	Width of fixed segment C	Product no.	Base price
2000	750	742-757	380	540	352-367	400306	937,-
	800	792-807	480	680	302-317	400307	
	900	892-907	580	820	302-317	400308	
	1000	992-1007	680	960	302-317	400309	975,-
	1200	1192-1207	680	965	502-517	400310	992,-

NOTE: Complete corner entry consisting of two item no. Right door see next page.



Made-to-measure - Left-hand fixing

Height	Width	Product no.	Base price
1600-2000	700-1200	400380	1.106,-

Adjustment range = dimensions - 8mm / + 7mm

The widths of the fixed segments are defined by HÜPPE.

Dim. Range: min. - max.

	
1600-2000	700-1200

Extras

Height	Profile	Product no.	Price
1900	Extension profile, 15mm	178002	32,-
2000	Extension profile, 15mm	178006	

Colours - Panel options

Profile colours	Colour code	Extra charges	Panel options	without Anti-Plaque		with Anti-Plaque	
				Glass code	Extra charges	Glass code	Extra charges
White	055	0,-	Clear	321	0,-	322	209,-
Matt silver	087		Sand Plus	315	186,-	316	395,-
Silver high-gloss	092	156,-	Privatima	373		375	

HÜPPE Aura elegance Rectangular

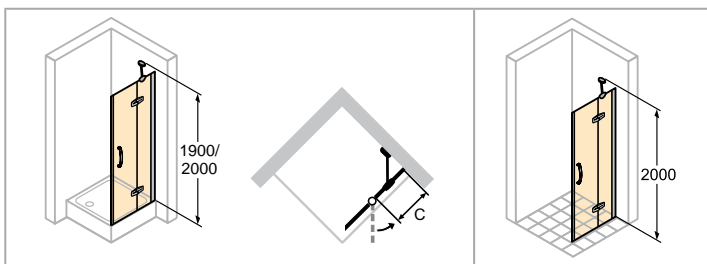

Right-hand fixing

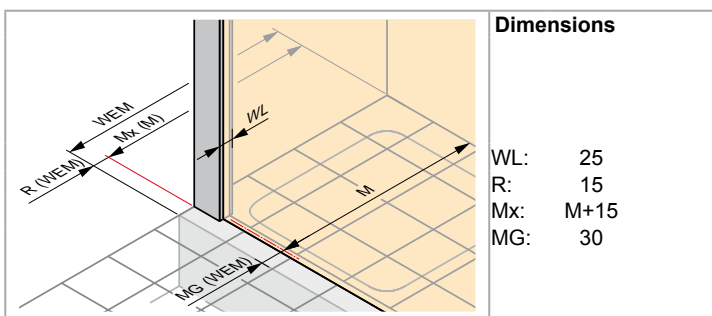

Dimensions

- WL: 25
- R: 15
- Mx: M+15
- MG: 30

WEM = Tray installation dim. (000)
 M = installation dimension Centre glass (001)
 Please always specify when ordering.

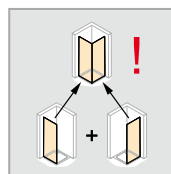
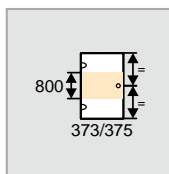
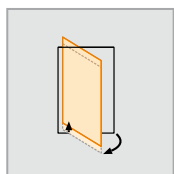
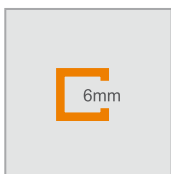

Swing door with fixed segment for side panel/corner entry

Right-hand fixing

Installation on shower tray recommended

Height	Model	WEM	M (middle of glass)	Entry width STS	Entry width STE	Width of fixed segment C	Product no.	Base price
1900	750	735-750	705-720	372	540	315-330	400404	851,-
	800	785-800	755-770	472	680	265-280	400401	
	900	885-900	855-870	572	820	265-280	400402	
	1000	985-1000	955-970	672	960	265-280	400403	887,-
	1200	1185-1200	1155-1170	672	965	465-480	400405	902,-
2000	750	735-750	705-720	372	540	315-330	400411	937,-
	800	785-800	755-770	472	680	265-280	400412	
	900	885-900	855-870	572	820	265-280	400413	
	1000	985-1000	955-970	672	960	265-280	400414	975,-
	1200	1185-1200	1155-1170	672	965	465-480	400415	992,-

NOTE: Complete corner entry consisting of two item no. Left door see previous page.

Right-hand fixing

Floor-flush installation recommended

Height	Model	M (middle of glass)	Entry width STS	Entry width STE	Width of fixed segment C	Product no.	Base price
2000	750	742-757	380	540	352-367	400406	937,-
	800	792-807	480	680	302-317	400407	
	900	892-907	580	820	302-317	400408	
	1000	992-1007	680	960	302-317	400409	975,-
	1200	1192-1207	680	965	502-517	400410	992,-

NOTE: Complete corner entry consisting of two item no. Left door see previous page.



Made-to-measure - Right-hand fixing

Height	Width	Product no.	Base price
1600-2000	700-1200	400480	1.106,-

Adjustment range = dimensions - 8mm / + 7mm

The widths of the fixed segments are defined by HÜPPE.

Dim. Range: min. - max.

	
1600-2000	700-1200

Extras

Height	Profile	Product no.	Price
1900	Extension profile, 15mm	178002	32,-
2000	Extension profile, 15mm	178006	

Colours - Panel options

Profile colours	Colour code	Extra charges	Panel options	without Anti-Plaque		with Anti-Plaque	
				Glass code	Extra charges	Glass code	Extra charges
White	055	0,-	Clear	321	0,-	322	209,-
Matt silver	087		Sand Plus	315	186,-	316	395,-
Silver high-gloss	092	156,-	Privatima	373		375	

HÜPPE Aura elegance Rectangular

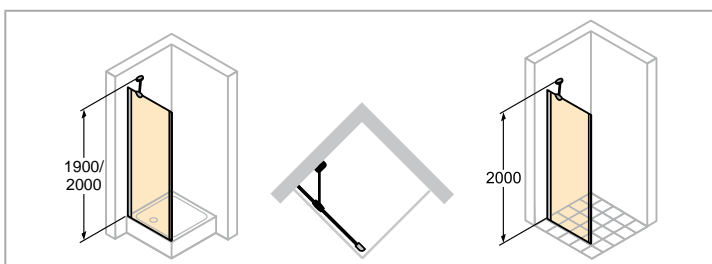

- Towel rail height can be selected individually and must be specified with the order. If nothing is specified, the towel rail is always delivered middle of glass (height and width).

Dimensions	
WL:	25
R:	15
Mx:	M+15
MG:	30

WEM = Tray installation dim. (000)
M = installation dimension Centre glass (001)
Please always specify when ordering.

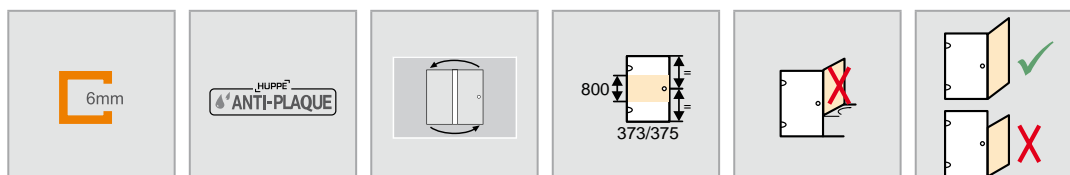

Side panel

Installation on shower tray recommended

Height	Model	WEM	M (middle of glass)	Product no.	Base price
1900	SW 700	685-700	655-670	400601	514,-
	SW 750	735-750	705-720	400602	
	SW 800	785-800	755-770	400603	
	SW 900	885-900	855-870	400604	
	SW 1000	985-1000	955-970	400605	535,-
2000	SW 700	685-700	655-670	400620	565,-
	SW 750	735-750	705-720	400621	
	SW 800	785-800	755-770	400622	
	SW 900	885-900	855-870	400623	
	SW 1000	985-1000	955-970	400624	587,-

Floor-flush installation recommended

Height	Model	M (middle of glass)	Product no.	Base price
2000	SW 700	692-707	400606	565,-
	SW 750	742-757	400607	
	SW 800	792-807	400608	
	SW 900	892-907	400609	
	SW 1000	992-1007	400610	587,-
	SW 1200	1192-1207	400611	598,-

Made-to-measure



Height	Width	Product no.	Base price
1600-2000	200-1200	400680	667,-

Adjustment range = dimensions - 8mm / + 7mm

Slopes and cut-outs

Slopes and cut-outs	Extra charges
 Supplement per slope/cut-out for made-to-measure	170,-

Dim. Range: min. - max.

	
1600-2000	200-1200

Special options

Special options	Product no.	Extra charges
Towel rail (silver high-gloss)	T99	210,-

Colours - Panel options

Profile colours	Colour code	Extra charges	Panel options		without Anti-Plaque		with Anti-Plaque	
			Glass code	Extra charges	Glass code	Extra charges		
White	055	0,-	Clear	321	0,-	322	209,-	
Matt silver	087	0,-	Sand Plus	315	186,-	316	395,-	
Silver high-gloss	092	114,-	Privatima	373		375		

HÜPPE Aura elegance Quadrant

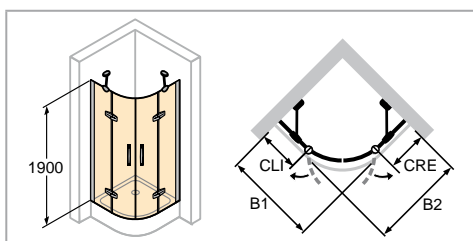

Dimensions	
WL:	25
R:	15
Mx:	M+15
MG:	30

WEM = Tray installation dim. (000)
M = installation dimension Centre glass (001)
Please always specify when ordering.

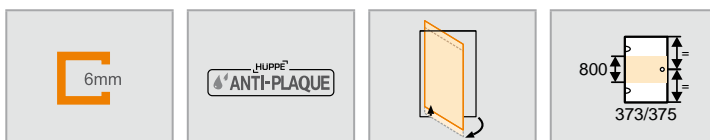

Swing door with fixed segments, 2-panel

Height	Model B1/B2	WEM B1/B2	M (middle of glass) B1/B2	CLI	CRE	Entry width	Radius	Product no.	Base price
1900	900 x 900	885-900	855-870	365	365	675	500	400801	1.892,-
	1000 x 1000	985-1000	955-970	465	465	675	500	400802	1.968,-
	900 x 900	885-900	855-870	330	330	725	550	400803	1.892,-
	1000 x 1000	985-1000	955-970	430	430	725	550	400804	1.968,-

Made-to-measure

Height	Width B1	Width B2	CLI	CRE	Radius	Product no.	Base price
1900	745-1135	745-1135	210-600	210-600	500	400880	2.462,-
	780-1170	780-1170	210-600	210-600	550	400881	

Adjustment range = dimensions - 8mm / + 7mm

Dim. Range: min. - max.

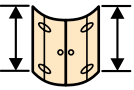
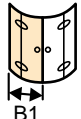
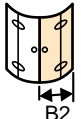
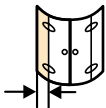
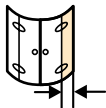
				
1900	745-1170	745-1170	210-600	210-600

Extras

Height	Profile	Product no.	Price
1900	Extension profile, 15mm 	178002	32,-

Colours - Panel options

Profile colours	Colour code	Extra charges	Panel options	without Anti-Plaque		with Anti-Plaque	
				Glass code	Extra charges	Glass code	Extra charges
White	055	0,-	Clear	321	0,-	322	418,-
Matt silver	087	0,-	Sand Plus	315	371,-	316	789,-
Silver high-gloss	092	312,-	Privatima	373		375	

HÜPPE Aura elegance Pentagonal

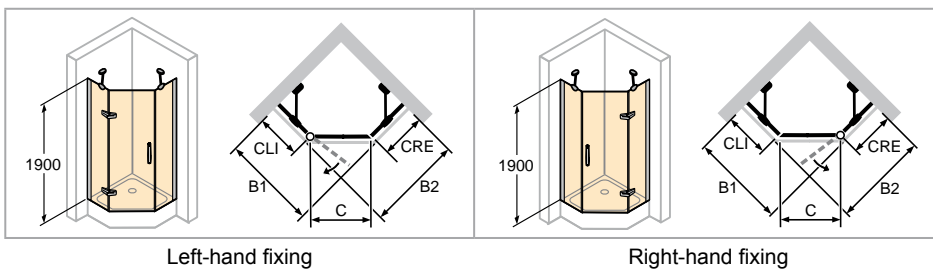

- Only compatible with the Purano pentagonal tray or trays with identical dimensions.

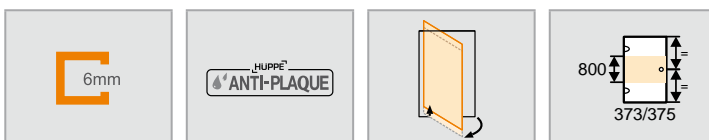
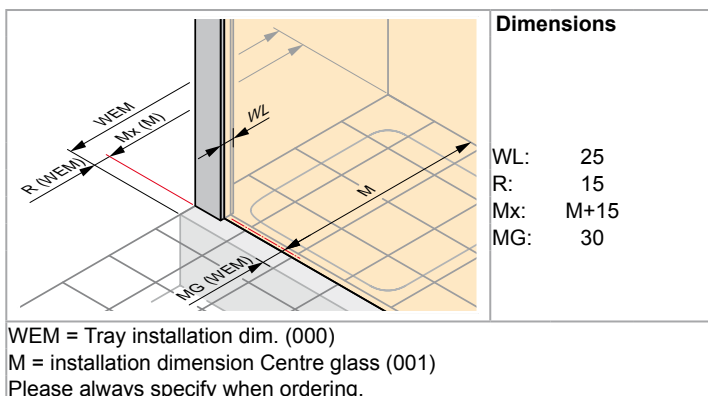

Swing door with fixed segments, 1-panel

Left-hand fixing

Height	Model B1/B2	WEM B1/B2	M (middle of glass) B1/B2	CLI/CRE	Entry width	C	Product no.	Base price
1900	900 x 900	885-900	855-870	420-435	585	636	400901	1.487,-
	1000 x 1000	985-1000	955-970	470-485	655	707	400902	1.547,-

Made-to-measure - Left-hand fixing

Height	Model B1/B2	CLI/CRE	C	Product no.	Base price
1600-2000	900 x 900	210-600	636	400980	1.932,-
	1000 x 1000	210-600	707	400981	

Adjustment range = dimensions - 8mm / + 7mm

Right-hand fixing

Height	Model B1/B2	WEM B1/B2	M (middle of glass) B1/B2	CLI/CRE	Entry width	C	Product no.	Base price
1900	900 x 900	885-900	855-870	420-435	585	636	401101	1.487,-
	1000 x 1000	985-1000	955-970	470-485	655	707	401102	1.547,-

Made-to-measure - Right-hand fixing

Height	Model B1/B2	CLI/CRE	C	Product no.	Base price
1600-2000	900 x 900	210-600	636	401180	1.932,-
	1000 x 1000	210-600	707	401181	

Adjustment range = dimensions - 8mm / + 7mm

Dim. Range: min. - max.

1600-2000	900/1000	900/1000	210-600	210-600

Extras

Height	Profile	Product no.	Price
1900	Extension profile, 15mm	178002	32,-
2000	Extension profile, 15mm	178006	

Colours - Panel options

Profile colours	Colour code	Extra charges	Panel options	without Anti-Plaqué		with Anti-Plaqué	
				Glass code	Extra charges	Glass code	Extra charges
White	055	0,-	Clear	321	0,-	322	418,-
Matt silver	087		Sand Plus	315	371,-	316	789,-
Silver high-gloss	092	312,-	Privatima	373		375	

HÜPPE Design elegance model overview - Base price

HÜPPE Design pure model overview - Base price

Rectangular

Sliding door, 2-section corner entry

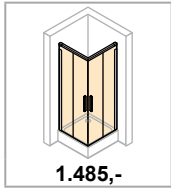

G.6-G.7

Sliding door, 1-panel with fixed segment

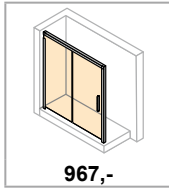

G.8-G.11

Side panel for sliding door 1-panel with fixed segment

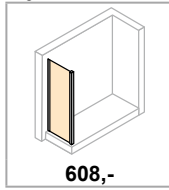

G.12-G.13

Sliding door with fixed segment and additional section

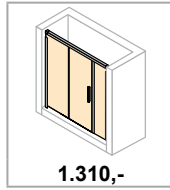

G.14-G.15

Sliding door, 2-panel with fixed segments

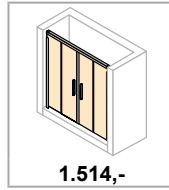

G.16-G.17

Side panel for sliding door 2-panel with fixed segments/Sliding door with fixed segment and additional section

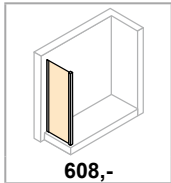

G.18-G.19

Quadrant

Sliding door

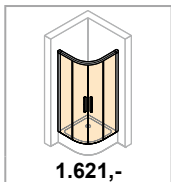

G.20-G.21

U-shaped enclosure

U-shaped enclosure

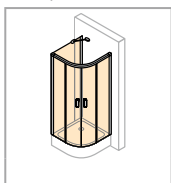

HÜPPE Design elegance model overview - Base price

HÜPPE Design pure model overview - Base price

Rectangular

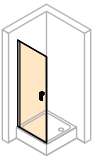
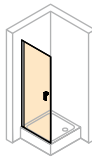
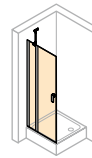
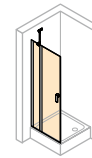
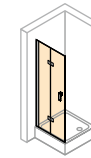
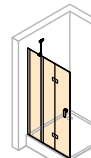
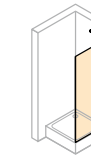
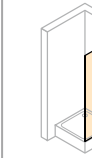
Swing door	Swing door opening inwards/outwards for combination with side panel	Swing door with fixed panel	Swing door with fixed segments opening inwards/outwards for combination with side panel	Folding swing door	Folding swing door with fixed segment	Side panel for swing door	Movable side panel swing door
							
G.28-G.29	G.30-G.31	G.32-G.35	G.36-G.37	G.42-G.45	G.46-G.49	G.50-G.51	G.52-G.53
		737,-		848,-	1.371,-	517,-	595,-

HÜPPE Design pure

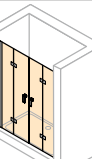
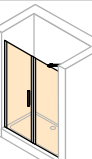
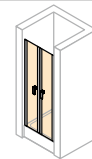
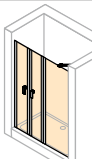
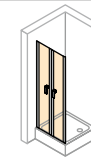
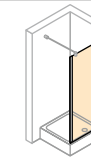
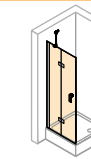
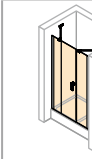
Two folding swing doors in recess	Swing door with additional section in recess	Two-way door in recess	Two-way door with fixed segment in recess	Two-way door for side panel	Side panel for two-way door	Swing door with fixed segment and fitting	Swing door with fixed segment and additional section in recess
							
G.54-G.55	G.56-G.57	G.60-G.61	G.62-G.63	G.64-G.65	G.66-G.67	G.38-G.41	G.58-G.59
1.485,-	1.056,-	848,-	1.188,-	848,-	517,-	791,-	1.318,-

Quadrant

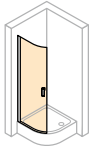
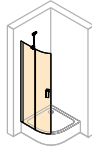
Swing door 2-panel (1/2)	Swing door with fixed segments, 2-panel (1/2)
	
G.68-G.69	G.70-G.71
	760,-

HÜPPE Design elegance Pentagonal

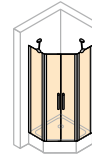
Swing door with fixed segments, 2-panel (1/2)

G.72-G.73
1.520,-

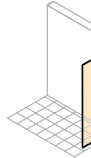
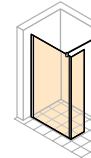
Walk-In

Free standing side panel	Walk-In side panel with movable segment
	
S.2-S.3	S.4-S.5
519,-	977,-

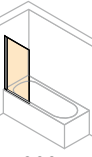
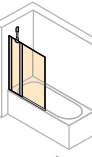
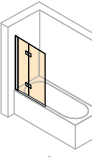
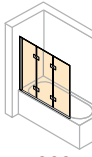
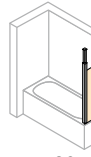
Bath-top shower screen

1-panel	1-panel with fixed segment	Folding swing door	3-panel	Side panel
				
T.4-T.5	T.6-T.7	T.8-T.9	T.10-T.11	T.12-T.13
366,-	541,-	737,-	822,-	423,-

U-shaped enclosure

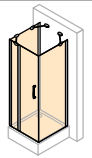
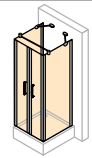
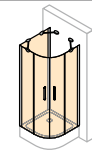
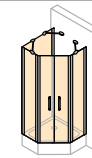
Swing door, rectangular U-shaped enclosure	Two-way door, rectangular U-shaped enclosure	Swing door, quadrant U-shaped enclosure	Swing door, pentagonal U-shaped enclosure
			
G.75-G.77	G.78	G.79-G.80	G.81
2.412,-	2.555,-	2.637,-	2.757,-

NEW

Swing door with fixed segment and fitting

All prices in EURO exclusive of VAT. All dimensions in mm

H.1

HÜPPE Design elegance sliding doors

HÜPPE Design pure sliding doors

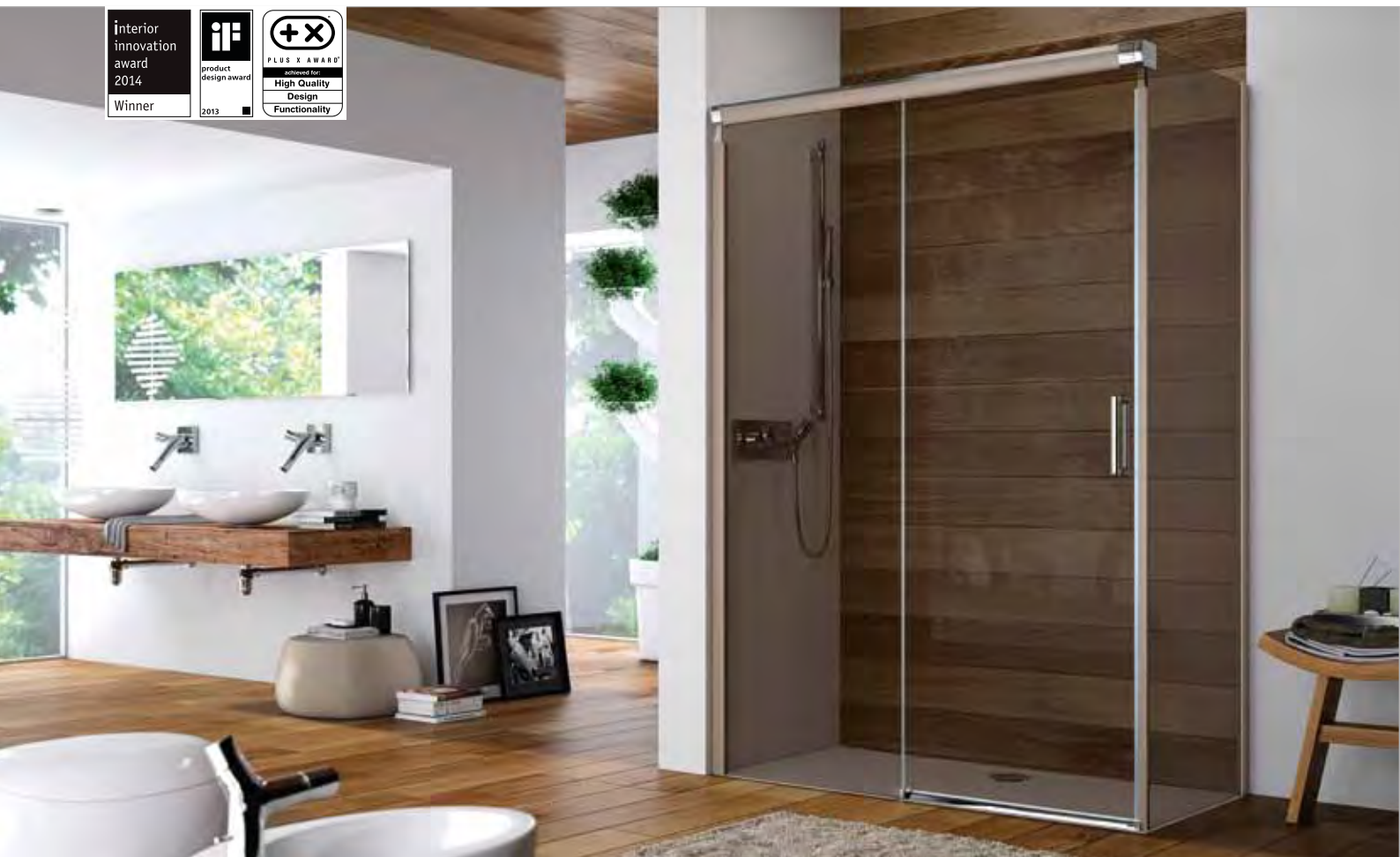

HÜPPE Design elegance swing doors

HÜPPE Design pure swing doors

Interior
innovation
award
2014
Winner



if
DESIGN
AWARD
2015



Product details

Sliding doors



Handle HÜPPE Design elegance



Handle HÜPPE Design pure



The transparent sliding doors of the HÜPPE Design series close independently thanks to the optional Soft-Open/Soft-Close mechanism



Concealed roller mechanism offers refined design and easy cleaning Roller system not visible



For particularly easy cleaning, the door segments can be engaged and disengaged without effort.



Towel rail in high-gloss silver for all side panels. If you order the towel rail as a special option, it is screw-fitted to the side panel. For a subsequent installation the towel rail can be ordered as an accessory (bonded installation).



Bicolour design high-gloss silver / white



Bicolour design high-gloss silver / matt silver



Bicolour design high-gloss silver / black



Bicolour design high-gloss silver/grey-brown

All models of the HÜPPE Design series can be optionally installed with a drip deflector strip for optimum tightness or as easy access units

Cover caps, handle and drip deflector strip always in high-gloss silver

Product details

Swing doors



Handle HÜPPE Design elegance



Handle HÜPPE Design pure

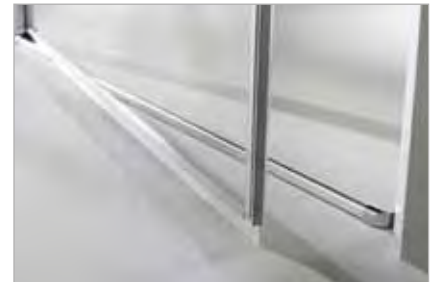

All models of the HÜPPE Design range can be installed with drip deflector strip for optimal water tightness or without deflector strip for easy entry



High-quality chrome applications:
Handle, stabilizer, cross-bracing, cover cap, the folding swinging door hinge and the drip deflector strip are always in chrome or high-gloss silver



Rise and fall mechanism on the hinge lifts the door by 5mm providing added water tightness, easy operation and longevity for the wear and tear parts

The door panel can be fixed in different positions using the raise/lower mechanism.



Towel rail in high-gloss silver for all side panels. If you order the towel rail as a special option, it is screw-fitted to the side panel. For a subsequent installation the towel rail can be ordered as an accessory (bonded installation).



Stabilizer Design elegance and HUEPPE Design pure

HÜPPE Design elegance Rectangular

HÜPPE Design pure Rectangular

elegance



pure

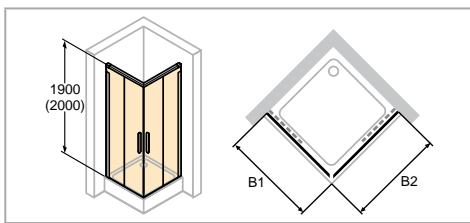

- Mirror glass (380/381): Please state in your order which segment should be produced with mirror glass. If this is not stated, the entire unit will be produced with mirror glass.
- For technical information, see Profile Colours and Panel Options section.

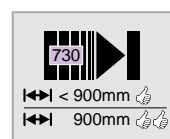
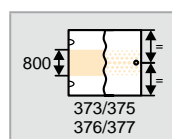
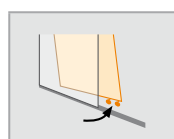
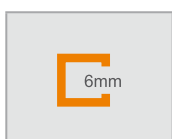
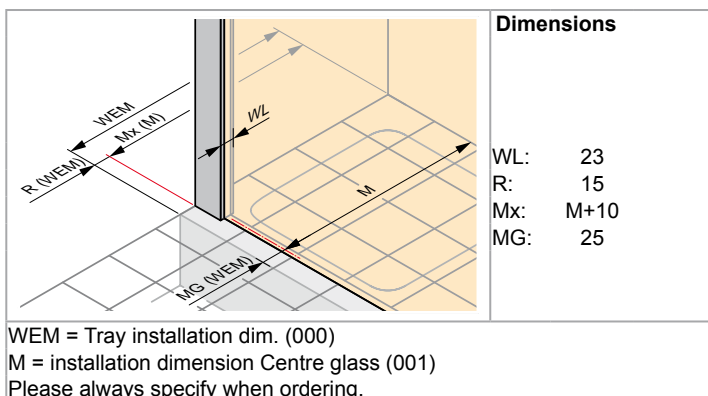

Sliding door, 2-section corner entry

Height	Model	WEM B1	WEM B2	M (middle of glass) B1	M (middle of glass) B2	Entry width	elegance	pure	Base price
1900	800x800	785-805	785-805	760-780	760-780	380-410	8E2901	8P2901	1.485,-
	900x900	885-905	885-905	860-880	880-860	450-480	8E2902	8P2902	
	1000x1000	985-1005	985-1005	960-980	960-980	520-550	8E2903	8P2903	1.545,-
	750x900	735-755	885-905	710-730	860-880	400-430	8E2904	8P2904	1.485,-
	900x750	885-905	735-755	860-880	710-730	400-430	8E2905	8P2905	
	800x1200	785-805	1185-1205	760-780	1160-1180	520-550	8E2906	8P2906	1.574,-
1200x800	1185-1205	785-805	1160-1180	760-780	520-550	8E2907	8P2907		
2000	800x800	785-805	785-805	760-780	760-780	380-410	8E2908	8P2908	1.633,-
	900x900	885-905	885-905	860-880	860-880	450-480	8E2909	8P2909	
	1000x1000	985-1005	985-1005	960-980	960-980	520-550	8E2910	8P2910	1.699,-
	750x900	735-755	885-905	710-730	860-880	400-430	8E2911	8P2911	1.633,-
	900x750	885-905	735-755	860-880	710-730	400-430	8E2912	8P2912	
	800x1200	785-805	1185-1205	760-780	1160-1180	520-550	8E2913	8P2913	1.733,-
1200x800	1185-1205	785-805	1160-1180	760-780	520-550	8E2914	8P2914		

Made-to-measure

Height	Width B1	Width B2	elegance	pure	Base price
1200-2000	700-1270	700-1270	8E2980	8P2980	1.931,-

Adjustment range = dimensions - 10mm / + 10mm

Dim. Range: min. - max.

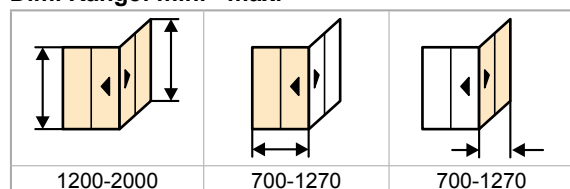

Special options

Optional variants		Extra charges
Soft-Open-/Soft-Close-function	730	138,-

Colours - Panel options

Profile colours	Colour code	Extra charges
White	055	0,-
Matt silver	087	
Black	023	312,-
Grey/brown	061	
Silver high-gloss	092	
High-gloss silver/matt silver	H87	
High-gloss silver/black	H23	
High-gloss silver/white	H55	
High-gloss silver/grey-brown	H61	

Panel options	without Anti-Plaque		with Anti-Plaque	
	Glass code	Extra charges	Glass code	Extra charges
Clear	321	0,-	322	418,-
Grey	301	371,-	368	789,-
Bronze	341		378	
Sand Plus	315		316	
Privatima	373	439,-	375	857,-
Bubbles	376		377	
Mirror glass	380		381	

HÜPPE Design elegance Rectangular

HÜPPE Design pure Rectangular

elegance



pure

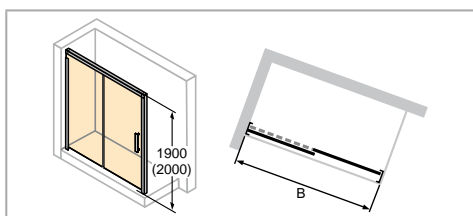

- Mirror glass (380/381): Please state in your order which segment should be produced with mirror glass. If this is not stated, the entire unit will be produced with mirror glass.
- For technical information, see Profile Colours and Panel Options section.

Dimensions	
WL:	23
R:	15
Mx:	M+10
MG:	25

WEM = Tray installation dim. (000)
M = installation dimension Centre glass (001)
Please always specify when ordering.

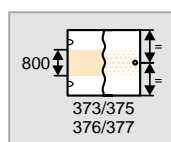
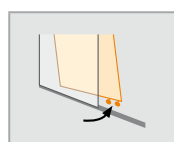
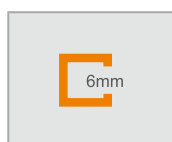

Sliding door, 1-panel with fixed segment

Left-hand fixing



Height	Model	WEM In recess	WEM Side panel	M (middle of glass) Recess	M (middle of glass) Side panel	Entry width	elegance	pure	Base price
1900	900	860-900	890-930	860-900	872-912	330-370	8E0101	8P0101	967,-
	1000	960-1000	990-1030	960-1000	972-1012	380-420	8E0102	8P0102	1.006,-
	1100	1060-1100	1090-1130	1060-1100	1072-1112	430-470	8E0103	8P0103	
	1200	1160-1200	1190-1230	1160-1200	1172-1212	480-520	8E0104	8P0104	1.023,-
	1300	1260-1300	1290-1330	1260-1300	1272-1312	530-570	8E0105	8P0105	
	1400	1360-1400	1390-1430	1360-1400	1372-1412	580-620	8E0106	8P0106	
	1500	1460-1500	1490-1530	1460-1500	1472-1512	630-670	8E0107	8P0107	
	1600	1560-1600	1590-1630	1560-1600	1572-1612	680-720	8E0108	8P0108	
	1700	1660-1700	1690-1730	1660-1700	1672-1712	730-770	8E0109	8P0109	
1800	1760-1800	1790-1830	1760-1800	1772-1812	780-820	8E0110	8P0110		
2000	900	860-900	890-930	860-900	872-912	330-370	8E0111	8P0111	1.062,-
	1000	960-1000	990-1030	960-1000	972-1012	380-420	8E0112	8P0112	1.104,-
	1100	1060-1100	1090-1130	1060-1100	1072-1112	430-470	8E0113	8P0113	
	1200	1160-1200	1190-1230	1160-1200	1172-1212	480-520	8E0114	8P0114	1.125,-
	1300	1260-1300	1290-1330	1260-1300	1272-1312	530-570	8E0115	8P0115	
	1400	1360-1400	1390-1430	1360-1400	1372-1412	580-620	8E0116	8P0116	
	1500	1460-1500	1490-1530	1460-1500	1472-1512	630-670	8E0117	8P0117	
	1600	1560-1600	1590-1630	1560-1600	1572-1612	680-720	8E0118	8P0118	
	1700	1660-1700	1690-1730	1660-1700	1672-1712	730-770	8E0119	8P0119	
1800	1760-1800	1790-1830	1760-1800	1772-1812	780-820	8E0120	8P0120		

Made-to-measure - Left-hand fixing

Height	Model	Width B	elegance	pure	Base price
1200-2000	In recess	900-2000	8E0180	8P0180	1.256,-
	For side panel	900-2000	8E0181	8P0181	
	For U-shaped enclosure	900-2000	8E0182	8P0182	

Adjustment range = dimensions - 20mm / + 20mm

Dim. Range: min. - max.

	
1200-2000	900-2000

Special options

Optional variants		Extra charges
Soft-Open-/Soft-Close-function	730	69,-

Colours - Panel options

Profile colours	Colour code	Extra charges	Panel options		without Anti-Plaque		with Anti-Plaque	
			Glass code	Extra charges	Glass code	Extra charges		
White	055	0,-	Clear	321	0,-	322	209,-	
Matt silver	087		Grey	301		368		
Black	023		Bronze	341		378		
Grey/brown	061		Sand Plus	315	186,-	316	395,-	
Silver high-gloss	092		Privatima	373		375		
High-gloss silver/matt silver	H87		Bubbles	376		377		
High-gloss silver/black	H23		Mirror glass	380	439,-	381	648,-	
High-gloss silver/white	H55							
High-gloss silver/grey-brown	H61							

HÜPPE Design elegance Rectangular

HÜPPE Design pure Rectangular

elegance



pure

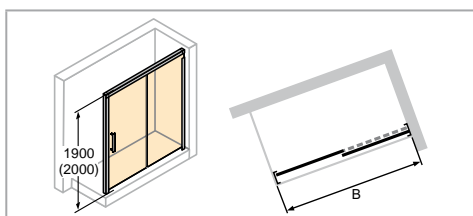

- Mirror glass (380/381): Please state in your order which segment should be produced with mirror glass. If this is not stated, the entire unit will be produced with mirror glass.
- For technical information, see Profile Colours and Panel Options section.

Dimensions	
	<p>WL: 23</p> <p>R: 15</p> <p>Mx: M+10</p> <p>MG: 25</p>
<p>WEM = Tray installation dim. (000)</p> <p>M = installation dimension Centre glass (001)</p> <p>Please always specify when ordering.</p>	

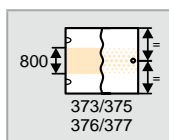
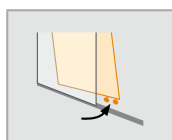
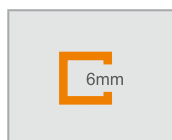

Sliding door, 1-panel with fixed segment

Right-hand fixing



Height	Model	WEM In recess	WEM Side panel	M (middle of glass) Recess	M (middle of glass) Side panel	Entry width	elegance	pure	Base price
1900	900	860-900	890-930	860-900	872-912	330-370	8E0201	8P0201	967,-
	1000	960-1000	990-1030	960-1000	972-1012	380-420	8E0202	8P0202	1.006,-
	1100	1060-1100	1090-1130	1060-1100	1072-1112	430-470	8E0203	8P0203	
	1200	1160-1200	1190-1230	1160-1200	1172-1212	480-520	8E0204	8P0204	1.023,-
	1300	1260-1300	1290-1330	1260-1300	1272-1312	530-570	8E0205	8P0205	
	1400	1360-1400	1390-1430	1360-1400	1372-1412	580-620	8E0206	8P0206	
	1500	1460-1500	1490-1530	1460-1500	1472-1512	630-670	8E0207	8P0207	
	1600	1560-1600	1590-1630	1560-1600	1572-1612	680-720	8E0208	8P0208	
1700	1660-1700	1690-1730	1660-1700	1672-1712	730-770	8E0209	8P0209		
1800	1760-1800	1790-1830	1760-1800	1772-1812	780-820	8E0210	8P0210		
2000	900	860-900	890-930	860-900	872-912	330-370	8E0211	8P0211	1.062,-
	1000	960-1000	990-1030	960-1000	972-1012	380-420	8E0212	8P0212	1.104,-
	1100	1060-1100	1090-1130	1060-1100	1072-1112	430-470	8E0213	8P0213	1.125,-
	1200	1160-1200	1190-1230	1160-1200	1172-1212	480-520	8E0214	8P0214	
	1300	1260-1300	1290-1330	1260-1300	1272-1312	530-570	8E0215	8P0215	
	1400	1360-1400	1390-1430	1360-1400	1372-1412	580-620	8E0216	8P0216	
	1500	1460-1500	1490-1530	1460-1500	1472-1512	630-670	8E0217	8P0217	
	1600	1560-1600	1590-1630	1560-1600	1572-1612	680-720	8E0218	8P0218	
1700	1660-1700	1690-1730	1660-1700	1672-1712	730-770	8E0219	8P0219		
1800	1760-1800	1790-1830	1760-1800	1772-1812	780-820	8E0220	8P0220		

Made-to-measure - Right-hand fixing

Height	Model	Width B	elegance	pure	Base price
1200-2000	In recess	900-2000	8E0280	8P0280	1.256,-
	For side panel	900-2000	8E0281	8P0281	
	For U-shaped enclosure	900-2000	8E0282	8P0282	

Adjustment range = dimensions - 20mm / + 20mm

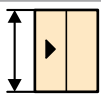
Dim. Range: min. - max.

	
1200-2000	900-2000

Special options

Optional variants		Extra charges
Soft-Open-/Soft-Close-function	730	69,-

Colours - Panel options

Profile colours	Colour code	Extra charges	Panel options		without Anti-Plaque		with Anti-Plaque	
			Glass code	Extra charges	Glass code	Extra charges		
White	055	0,- 156,-	Clear	321	0,-	322	209,-	
Matt silver	087		Grey	301		368		
Black	023		Bronze	341	186,-	378	395,-	
Grey/brown	061		Sand Plus	315		316		
Silver high-gloss	092		Privatima	373	375			
High-gloss silver/matt silver	H87		Bubbles	376	377			
High-gloss silver/black	H23		Mirror glass	380	439,-	381	648,-	
High-gloss silver/white	H55							
High-gloss silver/grey-brown	H61							

HÜPPE Design elegance Rectangular

HÜPPE Design pure Rectangular

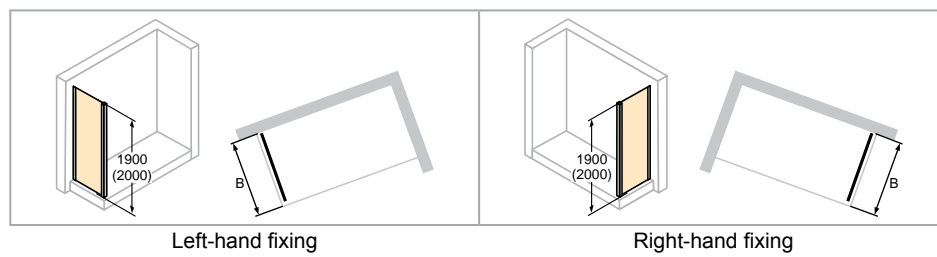
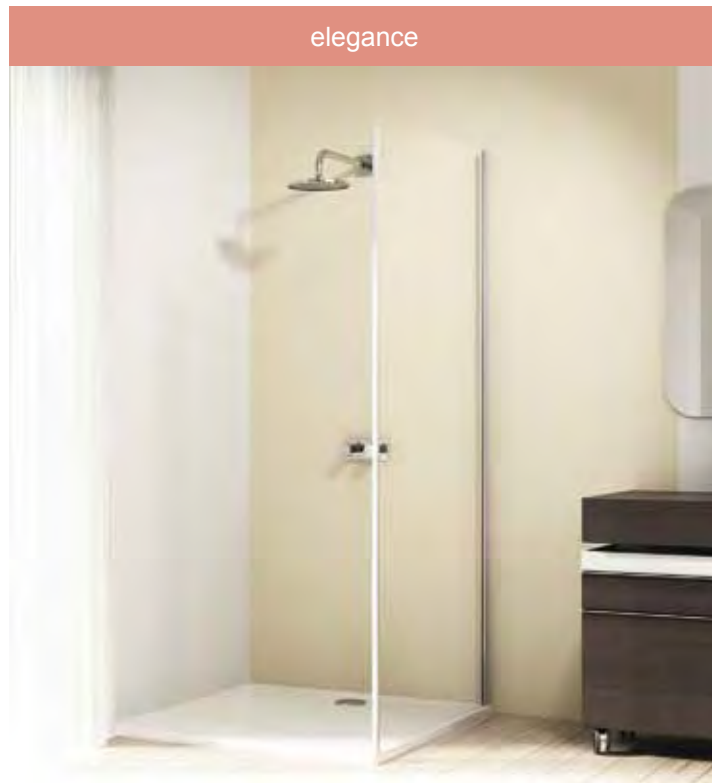

- Towel rail height can be selected individually and must be specified with the order. If nothing is specified, the towel rail is always delivered middle of glass (height and width).

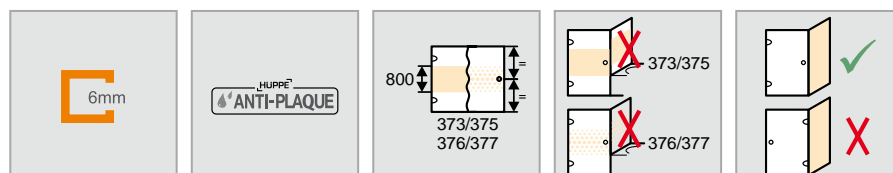
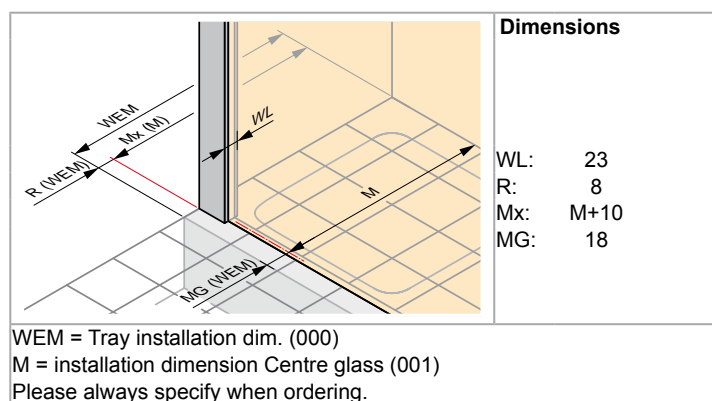

Side panel for sliding door 1-panel with fixed segment

Left-hand fixing

Height	Model	WEM B	M (middle of glass) B	elegance	pure	Base price
1900	SW 750	735-755	710-730	8E2701	8P2701	608,-
	SW 800	785-805	760-780	8E2702	8P2702	
	SW 900	885-905	860-880	8E2703	8P2703	
	SW 1000	985-1005	960-980	8E2704	8P2704	630,-
2000	SW 750	735-755	710-730	8E2705	8P2705	667,-
	SW 800	785-805	760-780	8E2706	8P2706	
	SW 900	885-905	860-880	8E2707	8P2707	
	SW 1000	985-1005	960-980	8E2708	8P2708	694,-

Made-to-measure - Left-hand fixing

Height	Model	Width B	elegance	pure	Base price
500-2000	Standard made-to-measure	200-1200	8E2780	8P2780	788,-
	On bathtub	200-1200	8E2782	8P2782	
	In-line configuration	200-1200	8E2781	8P2781	

Adjustment range = dimensions - 10mm / + 10mm

Right-hand fixing

Height	Model	WEM B	M (middle of glass) B	elegance	pure	Base price
1900	SW 750	735-755	710-730	8E2801	8P2801	608,-
	SW 800	785-805	760-780	8E2802	8P2802	
	SW 900	885-905	860-880	8E2803	8P2803	
	SW 1000	985-1005	960-980	8E2804	8P2804	630,-
2000	SW 750	735-755	710-730	8E2805	8P2805	667,-
	SW 800	785-805	760-780	8E2806	8P2806	
	SW 900	885-905	860-880	8E2807	8P2807	
	SW 1000	985-1005	960-980	8E2808	8P2808	694,-

Made-to-measure - Right-hand fixing

Height	Model	Width B	elegance	pure	Base price
500-2000	Standard made-to-measure	200-1200	8E2880	8P2880	788,-
	On bathtub	200-1200	8E2882	8P2882	
	In-line configuration	200-1200	8E2881	8P2881	

Adjustment range = dimensions - 10mm / + 10mm

Slopes and cut-outs

Slopes and cut-outs	Extra charges
 Supplement per slope/cut-out for made-to-measure	170,-

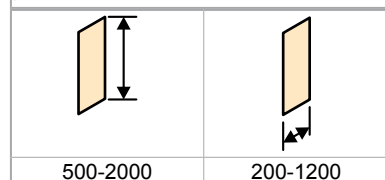

Special options

Optional variants	Extra charges
Towel rail (silver high-gloss)	T99 210,-

Colours - Panel options

Profile colours	Colour code	Extra charges	Panel options	without Anti-Plaque		with Anti-Plaque	
				Glass code	Extra charges	Glass code	Extra charges
White	055	0,-	Clear	321	0,-	322	209,-
Matt silver	087		Grey	301		368	
Silver high-gloss	092	114,-	Bronze	341		378	
Black	023	156,-	Sand Plus	315	186,-	316	395,-
Grey/brown	061		Privatima	373		375	
			Bubbles	376		377	
			Mirror glass	380	439,-	381	648,-

HÜPPE Design elegance Rectangular

HÜPPE Design pure Rectangular

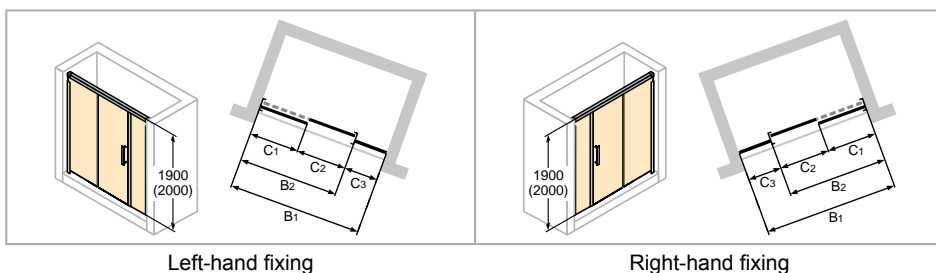
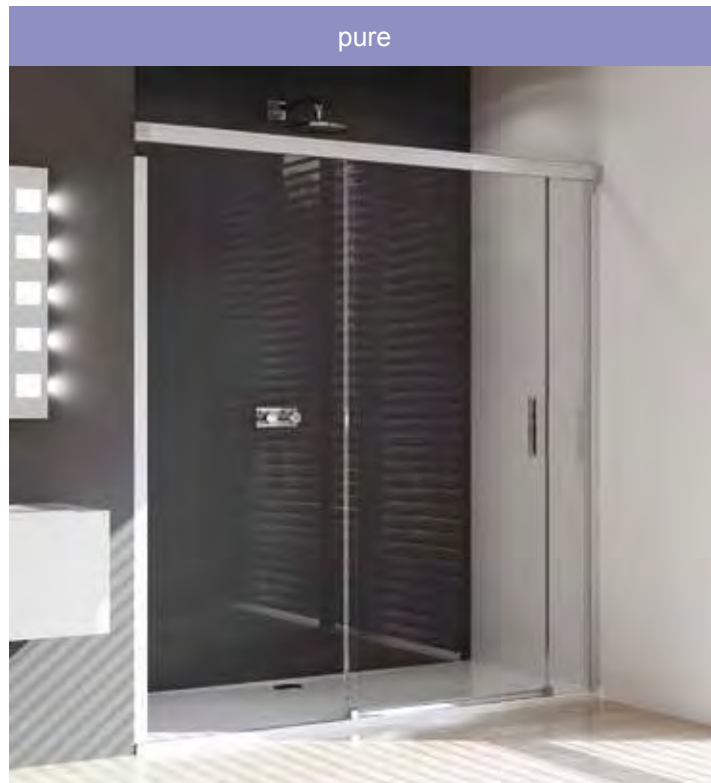

- Mirror glass (380/381): Please state in your order which segment should be produced with mirror glass. If this is not stated, the entire unit will be produced with mirror glass.
- For technical information, see Profile Colours and Panel Options section.

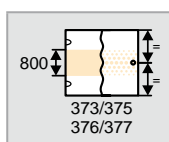
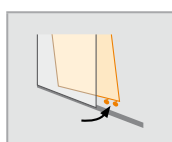
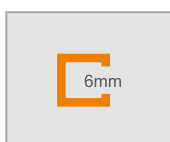
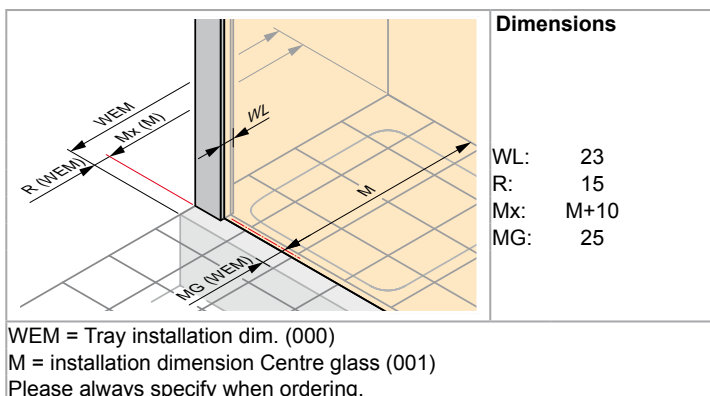

Sliding door with fixed segment and additional section

Left-hand fixing

Height	Model	WEM In recess	WEM Side panel	M (middle of glass) Recess	M (middle of glass) Side panel	Width C1	Width C2	Width C3	elegance	pure	Base price
1900	1600	1560-1600	1590-1630	1560-1600	1572-1612	670-685	575-615	211-226	8E0301	8P0301	1.310,-
	1700	1660-1700	1690-1730	1660-1700	1672-1712	720-735	625-665	211-226	8E0302	8P0302	
	1800	1760-1800	1790-1830	1760-1800	1772-1812	770-785	675-715	211-226	8E0303	8P0303	
2000	1600	1560-1600	1590-1630	1560-1600	1572-1612	670-685	575-615	211-226	8E0304	8P0304	1.440,-
	1700	1660-1700	1690-1730	1660-1700	1672-1712	720-735	625-665	211-226	8E0305	8P0305	
	1800	1760-1800	1790-1830	1760-1800	1772-1812	770-785	675-715	211-226	8E0306	8P0306	

Made-to-measure - Left-hand fixing

Height	Model	Width B1	Width B2	Additional section width	elegance	pure	Base price
1200-2000	In recess	1200-1800	1000-2200	200-1200	8E0380	8P0380	1.703,-
	In recess	1801-2400	1000-2200	200-1200	8E0387	8P0387	2.096,-
	For side panel	1200-1800	1000-2200	200-1200	8E0381	8P0381	1.703,-
	For side panel	1801-2400	1000-2200	200-1200	8E0388	8P0388	2.096,-
	For U-shaped enclosure	1200-1800	1000-2200	200-1200	8E0382	8P0382	1.703,-
	For U-shaped enclosure	1801-2400	1000-2200	200-1200	8E0389	8P0389	2.096,-

Adjustment range = dimensions - 20mm / + 20mm

Right-hand fixing

Height	Model	WEM In recess	WEM Side panel	M (middle of glass) Recess	M (middle of glass) Side panel	Width C1	Width C2	Width C3	elegance	pure	Base price
1900	1600	1560-1600	1590-1630	1560-1600	1572-1612	670-685	575-615	211-226	8E0401	8P0401	1.310,-
	1700	1660-1700	1690-1730	1660-1700	1672-1712	720-735	625-665	211-226	8E0402	8P0402	
	1800	1760-1800	1790-1830	1760-1800	1772-1812	770-785	675-715	211-226	8E0403	8P0403	
2000	1600	1560-1600	1590-1630	1560-1600	1572-1612	670-685	575-615	211-226	8E0404	8P0404	1.440,-
	1700	1660-1700	1690-1730	1660-1700	1672-1712	720-735	625-665	211-226	8E0405	8P0405	
	1800	1760-1800	1790-1830	1760-1800	1772-1812	770-785	675-715	211-226	8E0406	8P0406	

Made-to-measure - Right-hand fixing

Height	Model	Width B1	Width B2	Additional section width	elegance	pure	Base price
1200-2000	In recess	1200-1800	1000-2200	200-1200	8E0480	8P0480	1.703,-
	In recess	1801-2400	1000-2200	200-1200	8E0487	8P0487	2.096,-
	For side panel	1200-1800	1000-2200	200-1200	8E0481	8P0481	1.703,-
	For side panel	1801-2400	1000-2200	200-1200	8E0488	8P0488	2.096,-
	For U-shaped enclosure	1200-1800	1000-2200	200-1200	8E0482	8P0482	1.703,-
	For U-shaped enclosure	1801-2400	1000-2200	200-1200	8E0489	8P0489	2.096,-

Adjustment range = dimensions - 20mm / + 20mm

Dim. Range: min. - max.

1200-2000	1200-2400	1000-2200	200-1200

Special options

Optional variants	Extra charges
Soft-Open-/Soft-Close-function	730 69,-

Colours - Panel options

Profile colours	Colour code	Extra charges	Panel options				
			without Anti-Plaque Glass code	with Anti-Plaque Glass code			
White	055	0,- 312,-	Clear	321	0,-	322	418,-
Matt silver	087		Grey	301		368	
Black	023		Bronze	341		378	
Grey/brown	061		Sand Plus	315	371,-	316	789,-
Silver high-gloss	092		Privatima	373		375	
High-gloss silver/matt silver	H87		Bubbles	376		377	
High-gloss silver/black	H23		Mirror glass	380	439,-	381	857,-
High-gloss silver/white	H55						
High-gloss silver/grey-brown	H61						

HÜPPE Design elegance Rectangular

HÜPPE Design pure Rectangular

elegance



pure

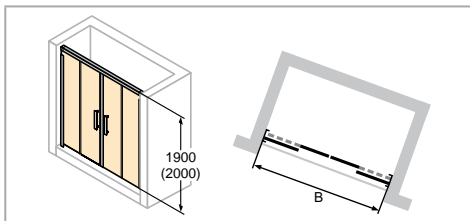

- Mirror glass (380/381): Please state in your order which segment should be produced with mirror glass. If this is not stated, the entire unit will be produced with mirror glass.
- For technical information, see Profile Colours and Panel Options section.

Dimensions

WL: 23
R: 15
Mx: M+10
MG: 25

WEM = Tray installation dim. (000)
M = installation dimension Centre glass (001)
Please always specify when ordering.

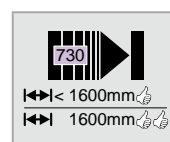
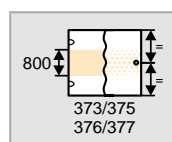
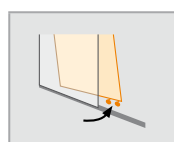
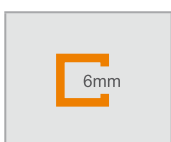

Sliding door, 2-panel with fixed segments



Height	Model	WEM In recess	WEM Side panel	M (middle of glass) Recess	M (middle of glass) Side panel	Entry width	elegance	pure	Base price
1900	1600	1560-1600	1590-1630	1560-1600	1572-1612	610-650	8E0501	8P0501	1.514,-
	1700	1660-1700	1690-1730	1660-1700	1672-1712	660-700	8E0502	8P0502	
	1800	1760-1800	1790-1830	1760-1800	1772-1812	710-750	8E0503	8P0503	
2000	1600	1560-1600	1590-1630	1560-1600	1572-1612	610-650	8E0504	8P0504	1.665,-
	1700	1660-1700	1690-1730	1660-1700	1672-1712	660-700	8E0505	8P0505	
	1800	1760-1800	1790-1830	1760-1800	1772-1812	710-750	8E0506	8P0506	

Made-to-measure

Height	Model	Width B	elegance	pure	Base price
1200-2000	In recess	1200-1800	8E0580	8P0580	1.968,-
	In recess	1801-2200	8E0587	8P0587	2.362,-
	For side panel	1200-1800	8E0581	8P0581	1.968,-
	For side panel	1801-2200	8E0588	8P0588	2.362,-
	For U-shaped enclosure	1200-1800	8E0582	8P0582	1.968,-
	For U-shaped enclosure	1801-2200	8E0589	8P0589	2.362,-

Adjustment range = dimensions - 20mm / + 20mm

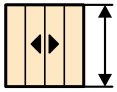
Dim. Range: min. - max.

	
1200-2000	1200-2200

Special options

Optional variants		Extra charges
Soft-Open-/Soft-Close-function	730	138,-

Colours - Panel options

Profile colours	Colour code	Extra charges	Panel options		without Anti-Plaque		with Anti-Plaque	
			Glass code	Extra charges	Glass code	Extra charges		
White	055	0,-	Clear	321	0,-	322	418,-	
Matt silver	087		Grey	301		368		
Black	023		Bronze	341		378		
Grey/brown	061		Sand Plus	315	371,-	316	789,-	
Silver high-gloss	092		Privatima	373		375		
High-gloss silver/matt silver	H87		Bubbles	376		377		
High-gloss silver/black	H23		Mirror glass	380	439,-	381	857,-	
High-gloss silver/white	H55							
High-gloss silver/grey-brown	H61							

HÜPPE Design elegance Rectangular

HÜPPE Design pure Rectangular

elegance



pure

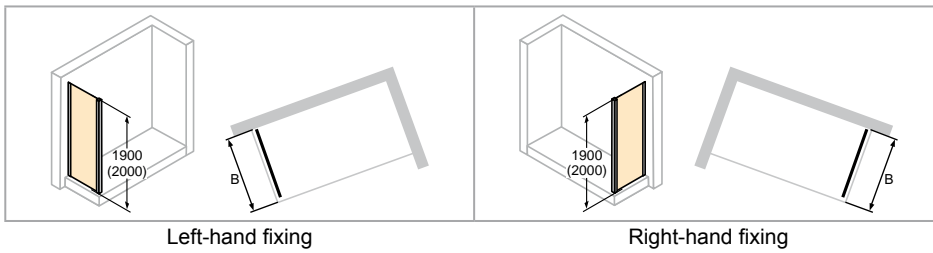

Left-hand fixing

Right-hand fixing

- Towel rail height can be selected individually and must be specified with the order. If nothing is specified, the towel rail is always delivered middle of glass (height and width).

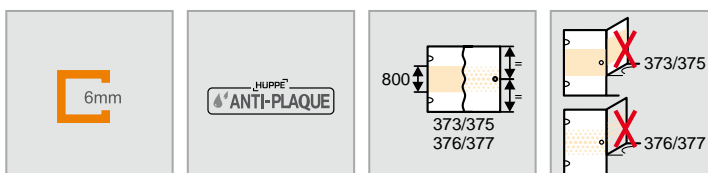
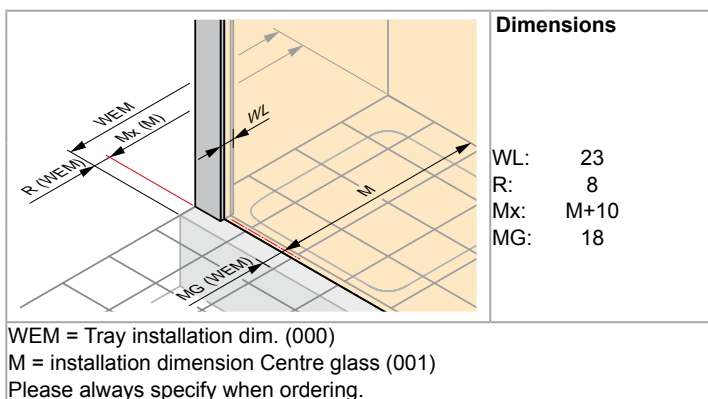

Side panel for sliding door 2-panel with fixed segments/Sliding door with fixed segment and additional section

Left-hand fixing

Height	Model	WEM B	M (middle of glass) B	elegance	pure	Base price
1900	750	735-755	710-730	8E5001	8P5001	608,-
	800	785-805	760-780	8E5002	8P5002	
	900	885-905	860-880	8E5003	8P5003	
	1000	985-1005	960-980	8E5004	8P5004	630,-
2000	750	735-755	710-730	8E5005	8P5005	667,-
	800	785-805	760-780	8E5006	8P5006	
	900	885-905	860-880	8E5007	8P5007	
	1000	985-1005	960-980	8E5008	8P5008	694,-

Made-to-measure - Left-hand fixing

Height	Model	Width B	elegance	pure	Base price
500-2000	Standard made-to-measure	200-1200	8E5080	8P5080	788,-
	On bathtub	200-1200	8E5082	8P5082	
	In-line configuration	200-1200	8E5081	8P5081	

Adjustment range = dimensions - 10mm / + 10mm

Right-hand fixing

Height	Model	WEM B	M (middle of glass) B	elegance	pure	Base price
1900	750	735-755	710-730	8E5101	8P5101	608,-
	800	785-805	760-780	8E5102	8P5102	
	900	885-905	860-880	8E5103	8P5103	
	1000	985-1005	960-980	8E5104	8P5104	630,-
2000	750	735-755	710-730	8E5105	8P5105	667,-
	800	785-805	760-780	8E5106	8P5106	
	900	885-905	860-880	8E5107	8P5107	
	1000	985-1005	960-980	8E5108	8P5108	694,-

Made-to-measure - Right-hand fixing



Height	Model	Width B	elegance	pure	Base price
500-2000	Standard made-to-measure	200-1200	8E5180	8P5180	788,-
	On bathtub	200-1200	8E5182	8P5182	
	In-line configuration	200-1200	8E5181	8P5181	

Adjustment range = dimensions - 10mm / + 10mm

Slopes and cut-outs

Slopes and cut-outs	Extra charges
 Supplement per slope/cut-out for made-to-measure	170,-

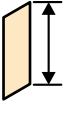
Dim. Range: min. - max.

	
500-2000	200-1200

Special options

Optional variants	Extra charges
Towel rail (silver high-gloss)	T99 210,-

Colours - Panel options

Profile colours	Colour code	Extra charges	Panel options	without Anti-Plaque		with Anti-Plaque	
				Glass code	Extra charges	Glass code	Extra charges
White	055	0,-	Clear	321	0,-	322	209,-
Matt silver	087		Grey	301		368	
Silver high-gloss	092	114,-	Bronze	341		378	
Black	023		Sand Plus	315	186,-	316	395,-
Grey/brown	061	156,-	Privatima	373		375	
			Bubbles	376		377	
			Mirror glass	380	439,-	381	648,-

HÜPPE Design elegance Quadrant

HÜPPE Design pure Quadrant

elegance



pure

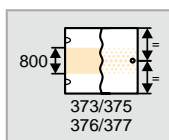
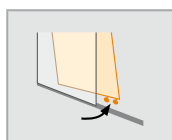
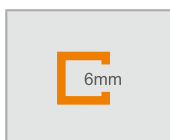
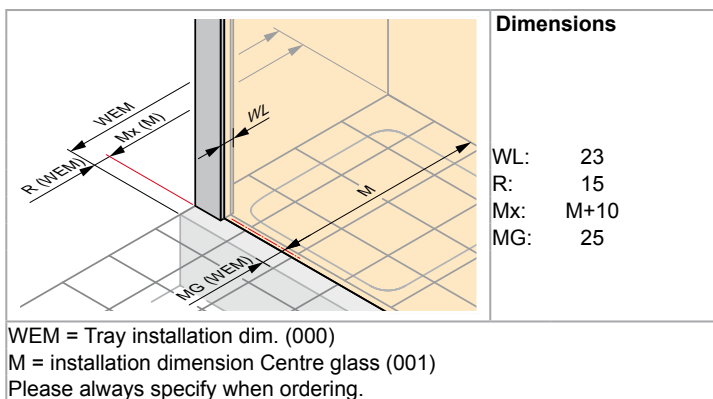
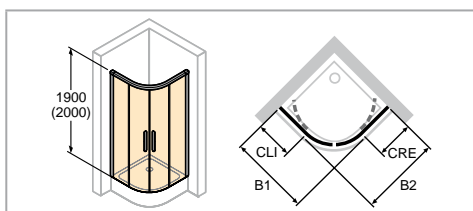

Sliding door

Height	Model B1/B2	WEM B1	WEM B2	M (middle of glass) B1/B2	CLI	CRE	Entry width	Radius	elegance	pure	Base price	
1900	800 x 800	785-805	785-805	760-780/760-780	300-320	300-320	465	500	8E3001	8P3001	1.621,-	
	900 x 900	885-905	885-905	860-880/860-880	400-420	400-420	465	500	8E3002	8P3002		
	1000 x 1000	985-1005	985-1005	960-980/960-980	500-520	500-520	465	500	8E3003	8P3003		1.683,-
	1200 x 1200	1185-1205	1185-1205	1160-1180/1160-1180	700-720	700-720	465	500	8E3004	8P3004		1.716,-
	750 x 900	735-755	885-905	710-730/860-880	250-270	400-420	465	500	8E3005	8P3005	1.621,-	
	900 x 750	885-905	735-755	860-880/710-730	400-420	250-270	465	500	8E3006	8P3006		
	800 x 900	785-805	885-905	760-780/860-880	300-320	400-420	465	500	8E3007	8P3007		
	900 x 800	885-905	785-805	860-880/760-780	400-420	300-320	465	500	8E3008	8P3008		
	800 x 1000	785-805	985-1005	760-780/960-980	300-320	500-520	465	500	8E3009	8P3009	1.683,-	
	1000 x 800	985-1005	785-805	960-980/760-780	500-520	300-320	465	500	8E3010	8P3010		
	800 x 1200	785-805	1185-1205	760-780/1160-1180	300-320	700-720	465	500	8E3013	8P3013	1.716,-	
	1200 x 800	1185-1205	785-805	1160-1180/760-780	700-720	300-320	465	500	8E3014	8P3014	1.683,-	
	900 x 1000	885-905	985-1005	860-880/960-980	400-420	500-520	465	500	8E3011	8P3011		
	1000 x 900	985-1005	885-905	960-980/860-880	500-520	400-420	465	500	8E3012	8P3012	1.716,-	
	900 x 1200	885-905	1185-1205	860-880/1160-1180	400-420	700-720	465	500	8E3015	8P3015		
	1200 x 900	1185-1205	885-905	1160-1180/860-880	700-720	400-420	465	500	8E3016	8P3016	1.621,-	
	800 x 800	785-805	785-805	760-780/760-780	255-275	255-275	445	550	8E3033	8P3033		
	900 x 900	885-905	885-905	860-880/860-880	355-375	355-375	510	550	8E3034	8P3034	1.683,-	
	1000 x 1000	985-1005	985-1005	960-980/960-980	455-475	455-475	510	550	8E3035	8P3035		
	1200 x 1200	1185-1205	1185-1205	1160-1180/1160-1180	655-675	655-675	510	550	8E3036	8P3036	1.716,-	
2000	800 x 800	785-805	785-805	760-780/760-780	300-320	300-320	465	500	8E3017	8P3017	1.781,-	
	900 x 900	885-905	885-905	860-880/860-880	400-420	400-420	465	500	8E3018	8P3018		
	1000 x 1000	985-1005	985-1005	960-980/960-980	500-520	500-520	465	500	8E3019	8P3019	1.852,-	
	1200 x 1200	1185-1205	1185-1205	1160-1180/1160-1180	700-720	700-720	465	500	8E3020	8P3020	1.888,-	
	750 x 900	735-755	885-905	710-730/860-880	250-270	400-420	465	500	8E3021	8P3021	1.781,-	
	900 x 750	885-905	735-755	860-880/710-730	400-420	250-270	465	500	8E3022	8P3022		
	800 x 900	785-805	885-905	760-780/860-880	300-320	400-420	465	500	8E3023	8P3023		
	900 x 800	885-905	785-805	860-880/760-780	400-420	300-320	465	500	8E3024	8P3024		
	800 x 1000	785-805	985-1005	760-780/960-980	300-320	500-520	465	500	8E3025	8P3025	1.852,-	
	1000 x 800	985-1005	785-805	960-980/760-780	500-520	300-320	465	500	8E3026	8P3026		
	800 x 1200	785-805	1185-1205	760-780/1160-1180	300-320	700-720	465	500	8E3029	8P3029	1.888,-	
	1200 x 800	1185-1205	785-805	1160-1180/760-780	700-720	300-320	465	500	8E3030	8P3030		
	900 x 1000	885-905	985-1005	860-880/960-980	400-420	500-520	465	500	8E3027	8P3027	1.852,-	
	1000 x 900	985-1005	885-905	960-980/860-880	500-520	400-420	465	500	8E3028	8P3028		
	900 x 1200	885-905	1185-1205	860-880/1160-1180	400-420	700-720	465	500	8E3031	8P3031	1.888,-	
	1200 x 900	1185-1205	885-905	1160-1180/860-880	700-720	400-420	465	500	8E3032	8P3032		
	800 x 800	785-805	785-805	760-780/760-780	255-275	255-275	445	550	8E3037	8P3037	1.781,-	
	900 x 900	885-905	885-905	860-880/860-880	355-375	355-375	510	550	8E3038	8P3038		
	1000 x 1000	985-1005	985-1005	960-980/960-980	455-475	455-475	510	550	8E3039	8P3039	1.852,-	
	1200 x 1200	1185-1205	1185-1205	1160-1180/1160-1180	655-675	655-675	510	550	8E3040	8P3040	1.888,-	

Made-to-measure

Height	Width B1	Width B2	CLI	CRE	Radius	elegance	pure	Base price
1900/2000	700-1195	700-1195	289-704	289-704	500	8E3080	8P3080	2.105,-
	700-1195	700-1195	289-704	289-704	550	8E3081	8P3081	

Adjustment range = dimensions - 10mm / + 10mm

Dim. Range: min. - max.

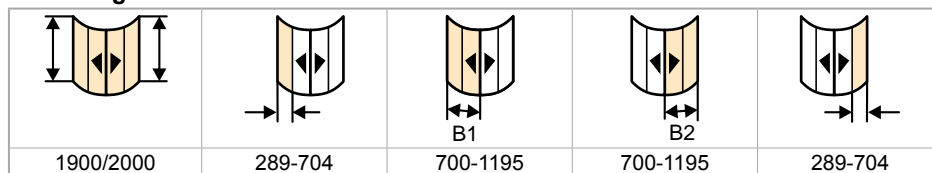

Colours - Panel options

Profile colours	Colour code	Extra charges
White	055	0,-
Matt silver	087	
Black	023	
Grey/brown	061	
Silver high-gloss	092	
High-gloss silver/matt silver	H87	
High-gloss silver/black	H23	
High-gloss silver/white	H55	312,-
High-gloss silver/grey-brown	H61	

Panel options	without Anti-Plaque		with Anti-Plaque	
	Glass code	Extra charges	Glass code	Extra charges
Clear	321	0,-	322	418,-
Sand Plus	315	371,-	316	789,-
Privatima	373		375	
Bubbles	376		377	

HÜPPE Design elegance U-shaped enclosure
HÜPPE Design pure U-shaped enclosure

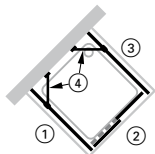
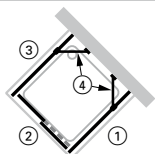
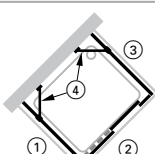
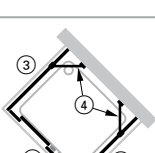
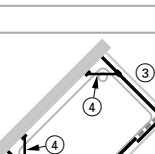
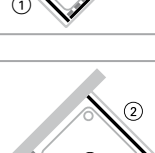
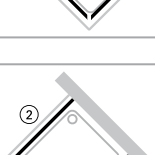
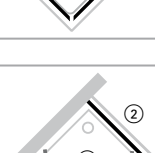
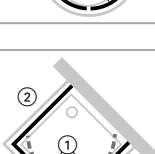

U-shaped enclosure

For ...		Item no.	
	Consisting of:	1	Side panel for sliding door 2-panel with fixed segments/Sliding door with fixed segment and additional section - Left-hand fixing
		2	Sliding door, 1-panel with fixed segment - Left-hand fixing 8E0182 (elegance) / 8P0182 (pure)
		3	Side panel for sliding door 1-panel with fixed segment - Right-hand fixing
		4	Stabilizer set for U-shaped enclosures 8P5201. See accessory side panel.
	Consisting of:	1	Side panel for sliding door 2-panel with fixed segments/Sliding door with fixed segment and additional section - Right-hand fixing
		2	Sliding door, 1-panel with fixed segment - Right-hand fixing 8E0282 (elegance) / 8P0282 (pure)
		3	Side panel for sliding door 1-panel with fixed segment - Left-hand fixing
		4	Stabilizer set for U-shaped enclosures 8P5201. See accessory side panel.
	Consisting of:	1	Side panel for sliding door 2-panel with fixed segments/Sliding door with fixed segment and additional section - Left-hand fixing
		2	Sliding door with fixed segment and additional section - Left-hand fixing 8E0382 (elegance) / 8P0382 (pure)
		3	Side panel for sliding door 2-panel with fixed segments/Sliding door with fixed segment and additional section - Right-hand fixing
		4	Stabilizer set for U-shaped enclosures 8P5201. See accessory side panel.
	Consisting of:	1	Side panel for sliding door 2-panel with fixed segments/Sliding door with fixed segment and additional section - Right-hand fixing
		2	Sliding door with fixed segment and additional section - Right-hand fixing 8E0482 (elegance) / 8P0482 (pure)
		3	Side panel for sliding door 2-panel with fixed segments/Sliding door with fixed segment and additional section - Left-hand fixing
		4	Stabilizer set for U-shaped enclosures 8P5201. See accessory side panel.
	Consisting of:	1	Side panel for sliding door 2-panel with fixed segments/Sliding door with fixed segment and additional section - Left-hand fixing
		2	Sliding door, 2-panel with fixed segments 8E0582 (elegance) / 8P0582 (pure)
		3	Side panel for sliding door 2-panel with fixed segments/Sliding door with fixed segment and additional section - Right-hand fixing
		4	Stabilizer set for U-shaped enclosures 8P5201. See accessory side panel.
	Consisting of:	1	Sliding door, 2-section corner entry left elegance/pure
		2	Side panel for sliding door 2-panel with fixed segments/Sliding door with fixed segment and additional section, right-hand fixing elegance pure
	Consisting of:	1	Sliding door, 2-section corner entry right elegance/pure
		2	Side panel for sliding door 2-panel with fixed segments/sliding door with fixed segment and additional section, left-hand fixing elegance pure
	Consisting of:	1	Quadrant sliding door, elegance/pure
		2	Side panel for sliding door 2-panel with fixed segments/Sliding door with fixed segment and additional section, right-hand fixing elegance pure
	Consisting of:	1	Quadrant sliding door, elegance/pure
		2	Side panel for sliding door 2-panel with fixed segments/sliding door with fixed segment and additional section, left-hand fixing elegance pure



It must be stated whether the specified dimensions refer to the tray installation dimensions or the middle glass installation dimensions (e.g. floor-flush).

The following therefore needs to be specified in the order with respect to dimensions:



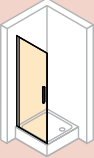
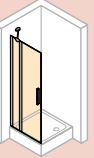
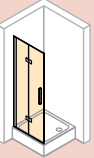
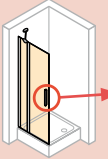
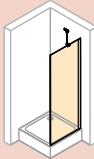
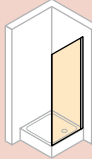
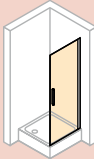
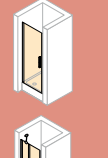
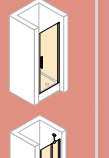
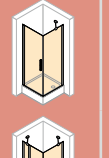
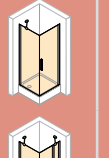
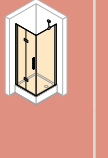
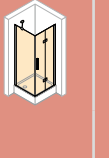
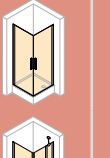
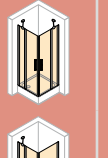
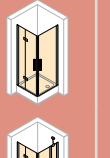

Refers to the tray installation dimensions: 000

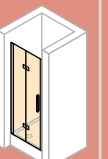
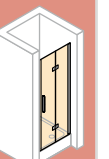
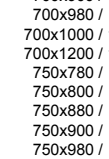
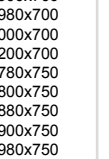
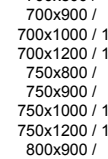
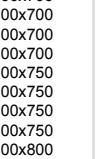
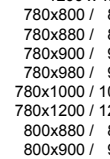
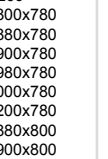
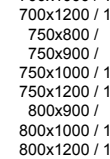
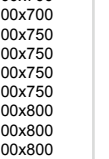
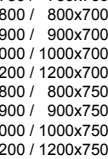
Refers to the middle glass installation dimensions: 001

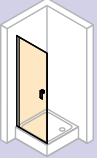
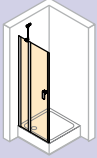
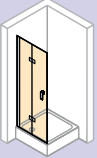
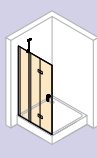

HÜPPE Design elegance combination options

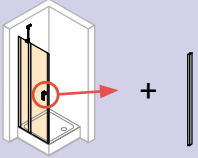
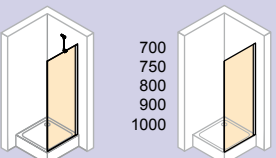
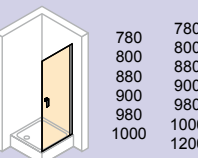
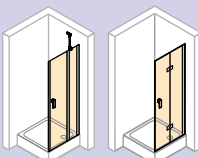
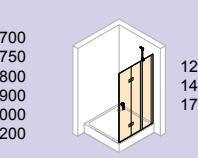
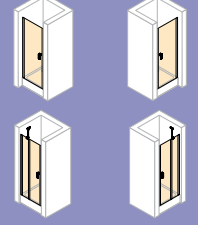
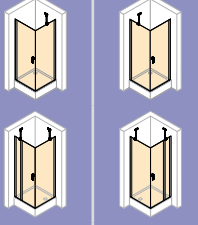
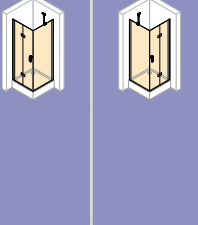
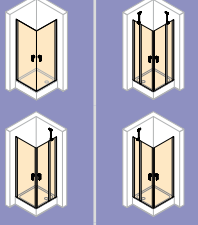
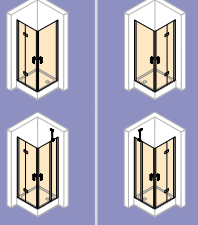
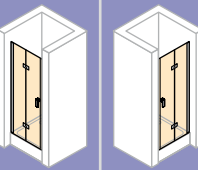
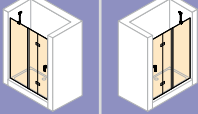
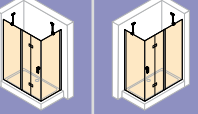
780 800 880 900 980 1000		780 800 880 900 980 1000 1200			700 750 800 900 1000 1200
+	+	+			
		700 750 800 900 1000			780 800 880 900 980 1000 1200
=	=	=			
 	 	 	 	 	
780 800 880 900 980 1000	800 x 800 900 x 900 1000 x 1000 700x780 / 780x700 700x800 / 800x700 700x880 / 880x700 700x900 / 900x700 700x980 / 980x700 700x1000 / 1000x700 700x1200 / 1200x700 750x780 / 780x750 750x800 / 800x750 750x880 / 880x750 750x900 / 900x750 750x980 / 980x750 750x1000 / 1000x750 800x900 / 900x800 800x1000 / 1000x800 800x1200 / 1200x800 900x900 / 900x800 900x1000 / 1000x800 900x1200 / 1200x800 1000x1000 / 1000x750 1000x1200 / 1200x750 800x880 / 880x800 800x980 / 980x800 800x1000 / 1000x800 800x1200 / 1200x800 900x880 / 880x900 900x980 / 980x900 900x1000 / 1000x900 900x1200 / 1200x900 1000x980 / 980x900 1000x1000 / 1000x900 1000x1200 / 1200x900	700 x 700 750 x 750 800 x 800 900 x 900 1000 x 1000 700x750 / 750x700 700x800 / 800x700 700x900 / 900x700 700x1000 / 1000x700 700x1200 / 1200x700 750x800 / 800x750 750x900 / 900x750 750x1000 / 1000x750 750x1200 / 1200x750 800x900 / 900x800 800x1000 / 1000x800 800x1200 / 1200x800 900x1000 / 900x800 900x1200 / 1200x900 1000x1200 / 1200x1000	780 x 780 800 x 800 880 x 880 900 x 900 980 x 980 1000 x 1000 1200 x 1200 780x800 / 800x780 780x880 / 880x780 780x900 / 900x780 780x980 / 980x780 780x1000 / 1000x780 780x1200 / 1200x780 800x880 / 880x800 800x900 / 900x800 800x980 / 980x800 800x1000 / 1000x800 800x1200 / 1200x800 880x900 / 900x880 880x980 / 980x880 880x1000 / 1000x880 880x1200 / 1200x880 900x980 / 980x900 900x1000 / 1000x900 900x1200 / 1200x900 980x1000 / 1000x980 980x1200 / 1200x980 1000x1200 / 1200x1000	800 x 800 900 x 900 1000 x 1000 700x750 / 750x700 700x800 / 800x700 700x900 / 900x700 700x1000 / 1000x700 700x1200 / 1200x700 750x800 / 800x750 750x900 / 900x750 750x1000 / 1000x750 750x1200 / 1200x750 800x900 / 900x800 800x1000 / 1000x800 800x1200 / 1200x800 900x1200 / 1200x900 1000x1200 / 1200x1000	700 x 700 750 x 750 800 x 800 900 x 900 1000 x 1000 1200 x 1200 700x750 / 750x700 700x800 / 800x700 700x900 / 900x700 700x1000 / 1000x700 700x1200 / 1200x700 750x800 / 800x750 750x900 / 900x750 750x1000 / 1000x750 750x1200 / 1200x750 800x900 / 900x800 800x1000 / 1000x800 800x1200 / 1200x800 900x1000 / 1000x900 900x1200 / 1200x900 1000x1200 / 1200x1000
 	 	 	 	 	
700 750 800 900 1000 1200	700x1200 / 1200x700 700x1400 / 1400x700 700x1700 / 1700x700 750x1200 / 1200x750 750x1400 / 1400x750 750x1700 / 1700x750 800x1200 / 1200x800 800x1400 / 1400x800 800x1700 / 1700x800 900x1200 / 1200x900 900x1400 / 1400x900 900x1700 / 1700x900 1000x1200 / 1200x1000 1000x1400 / 1400x1000 1000x1700 / 1700x1000		800x1200 / 1200x800 800x1400 / 1400x800 800x1700 / 1700x800 900x1200 / 1200x900 900x1400 / 1400x900 900x1700 / 1700x900 1000x1200 / 1200x1000 1000x1400 / 1400x1000 1000x1700 / 1700x1000	1200x1200 700x1200 / 1200x700 700x1400 / 1400x700 700x1700 / 1700x700 750x1200 / 1200x750 750x1400 / 1400x750 750x1700 / 1700x750 800x1200 / 1200x800 800x1400 / 1400x800 800x1700 / 1700x800 900x1200 / 1200x900 900x1400 / 1400x900 900x1700 / 1700x900 1000x1200 / 1200x1000 1000x1400 / 1400x1000 1000x1700 / 1700x1000 1200x1400 / 1400x1200 1200x1700 / 1700x1200 1400x1700 / 1700x1400	1200x1200 1400x1400 1700x1700 1200x1400 / 1400x1200 1200x1700 / 1700x1200 1400x1700 / 1700x1400

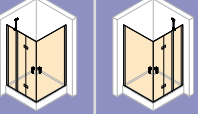
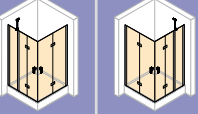
HÜPPE Design pure combination options

<p>780 800 880 900 980 1000</p> 	<p>780 800 880 900 980 1000 1200</p> 	<p>700 750 800 880 900 980 1000 1200</p> 	<p>700 750 800 880 900 980 1000 1200</p> 	<p>1200 1400 1700</p> 	
<p>+</p> 	<p>+</p> 	<p>+</p> 	<p>+</p> 	<p>+</p> 	
<p>=</p> 	<p>=</p> 	<p>=</p> 	<p>=</p> 	<p>=</p> 	
<p>780 800 880 900 980 1000</p> 	<p>800 x 800 900 x 900 1000 x 1000 700x780 / 780x700 700x800 / 800x700 700x880 / 880x700 700x900 / 900x700 700x980 / 980x700 700x1000 / 1000x700 700x1200 / 1200x700 750x780 / 780x750 750x800 / 800x750 750x880 / 880x750 750x900 / 900x750 750x980 / 980x750 750x1000 / 1000x750 750x1200 / 1200x750 800x800 / 800x800 800x900 / 900x800 800x1000 / 1000x800 750x1200 / 1200x750 800x780 / 780x800 800x880 / 880x800 800x980 / 980x800 800x1000 / 1000x800 800x1200 / 1200x800 900x780 / 780x900 900x880 / 880x900 900x980 / 980x900 900x1000 / 1000x900 900x1200 / 1200x900 1000x780 / 780x1000 1000x880 / 880x1000 1000x980 / 980x1000 1000x1000 / 1000x1000</p>	<p>700 x 700 750 x 750 800 x 800 900 x 900 1000 x 1000 700x750 / 750x700 700x800 / 800x700 700x900 / 900x700 700x1000 / 1000x700 700x1200 / 1200x700 750x800 / 800x750 750x900 / 900x750 750x1000 / 1000x750 750x1200 / 1200x750 800x900 / 900x800 800x1000 / 1000x800 800x1200 / 1200x800 900x1000 / 900x800 900x1200 / 1200x900 1000x1200 / 1200x1000</p>	<p>780 x 780 800 x 800 880 x 880 900 x 900 980 x 980 1000 x 1000 1200 x 1200 780x800 / 800x780 780x880 / 880x780 780x900 / 900x780 780x980 / 980x780 780x1000 / 1000x780 780x1200 / 1200x780 800x880 / 880x800 800x900 / 900x800 800x980 / 980x800 800x1000 / 1000x800 800x1200 / 1200x800 880x900 / 900x880 880x980 / 980x880 880x1000 / 1000x880 880x1200 / 1200x880 900x980 / 980x900 900x1000 / 1000x900 900x1200 / 1200x900 980x1000 / 1000x980 980x1200 / 1200x980 1000x1200 / 1200x1000</p>	<p>800 x 800 900 x 900 1000 x 1000 700x750 / 750x700 700x800 / 800x700 700x900 / 900x700 700x1000 / 1000x700 700x1200 / 1200x700 750x800 / 800x750 750x900 / 900x750 750x1000 / 1000x750 750x1200 / 1200x750 800x900 / 900x800 800x1000 / 1000x800 800x1200 / 1200x800 900x1000 / 1000x900 900x1200 / 1200x900 1000x1200 / 1200x1000</p>	<p>700 x 700 750 x 750 800 x 800 900 x 900 1000 x 1000 1200 x 1200 700x750 / 750x700 700x800 / 800x700 700x900 / 900x700 700x1000 / 1000x700 700x1200 / 1200x700 750x800 / 800x750 750x900 / 900x750 750x1000 / 1000x750 750x1200 / 1200x750 800x900 / 900x800 800x1000 / 1000x800 800x1200 / 1200x800 900x1000 / 1000x900 900x1200 / 1200x900 1000x1200 / 1200x1000</p>
					
<p>1200 1400 1700</p>	<p>700x1200 / 1200x700 700x1400 / 1400x700 700x1700 / 1700x700 750x1200 / 1200x750 750x1400 / 1400x750 750x1700 / 1700x750 800x1200 / 1200x800 800x1400 / 1400x800 800x1700 / 1700x800 900x1200 / 1200x900 900x1400 / 1400x900 900x1700 / 1700x900 1000x1200 / 1200x1000 1000x1400 / 1400x1000 1000x1700 / 1700x1000</p>	<p>800x1200 / 1200x800 800x1400 / 1400x800 800x1700 / 1700x800 900x1200 / 1200x900 900x1400 / 1400x900 900x1700 / 1700x900 1000x1200 / 1200x1000 1000x1400 / 1400x1000 1000x1700 / 1700x1000</p>	<p>1200x1200 700x1200 / 1200x700 700x1400 / 1400x700 700x1700 / 1700x700 750x1200 / 1200x750 750x1400 / 1400x750 750x1700 / 1700x750 800x1200 / 1200x800 800x1400 / 1400x800 800x1700 / 1700x800 900x1200 / 1200x900 900x1400 / 1400x900 900x1700 / 1700x900 1000x1200 / 1200x1000 1000x1400 / 1400x1000 1000x1700 / 1700x1000 1200x1400 / 1400x1200 1200x1700 / 1700x1200</p>	<p>1200x1200 1400x1400 1700x1700 1200x1400 / 1400x1200 1200x1700 / 1700x1200 1400x1700 / 1700x1400</p>	<p>1200x1200 1400x1400 1700x1700 1200x1400 / 1400x1200 1200x1700 / 1700x1200 1400x1700 / 1700x1400</p>

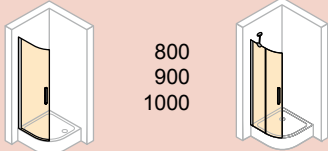
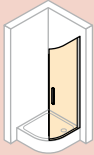
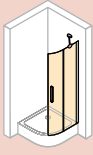
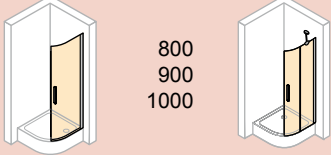
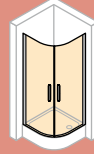
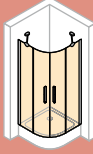
HÜPPE Design elegance combination options

		
+	+	+
 800 900 1000	 800 900 1000	 800 900 1000
=	=	=
		
800 x 800 900 x 900 1000 x 1000 800 x 900 / 900 x 800 800 x 1000 / 1000 x 800 900 x 1000 / 1000 x 900	800 x 800 900 x 900 1000 x 1000 800 x 900 / 900 x 800 800 x 1000 / 1000 x 800 900 x 1000 / 1000 x 900	800 x 800 900 x 900 1000 x 1000 800 x 900 / 900 x 800 800 x 1000 / 1000 x 800 900 x 1000 / 1000 x 900

HÜPPE Design pure combination options

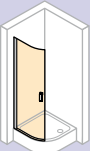
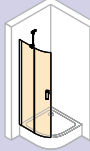
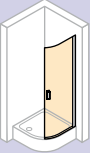
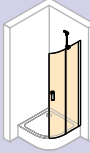
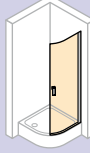
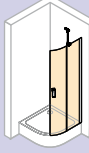
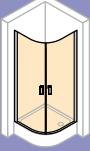
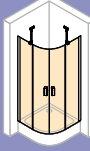
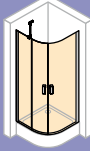
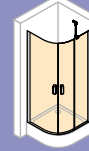
 <p>800 900 1000</p> 		
+	+	+
 <p>800 900 1000</p>	 <p>800 900 1000</p>	 <p>800 900 1000</p> 
=	=	=
		 
<p>800 x 800 900 x 900 1000 x 1000 800 x 900 / 900 x 800 800 x 1000 / 1000 x 800 900 x 1000 / 1000 x 900</p>	<p>800 x 800 900 x 900 1000 x 1000 800 x 900 / 900 x 800 800 x 1000 / 1000 x 800 900 x 1000 / 1000 x 900</p>	<p>800 x 800 900 x 900 1000 x 1000 800 x 900 / 900 x 800 800 x 1000 / 1000 x 800 900 x 1000 / 1000 x 900</p>

HÜPPE Design elegance Rectangular

HÜPPE Design pure Rectangular

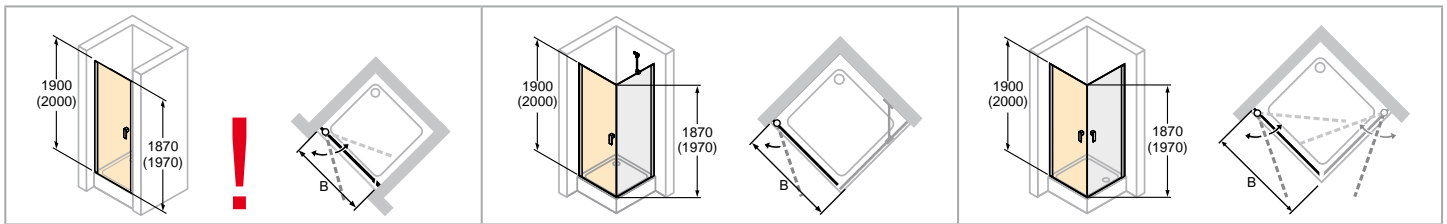

STN =
ST + profile for recess installation

STS = ST + SW

STE = 2 x ST

! Recess profile is required for swing doors in recess or door combined with shortened side panel.

- STS: Only outwards opening. Inwards opening also possible with inwards/outwards opening supplement set.
- Sloping sections possible. For recess solutions always with straight cut profile on closing side.
- Mirror glass (380/381): Please state in your order which segment should be produced with mirror glass. If this is not stated, the entire unit will be produced with mirror glass.
- For technical information, see Profile Colours and Panel Options section.

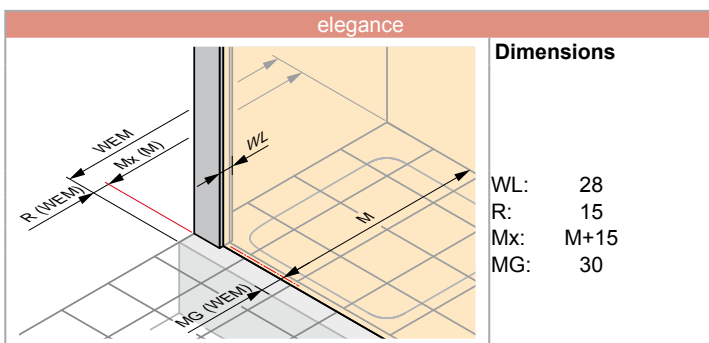

Dimensions

- WL: 28
- R: 15
- Mx: M+15
- MG: 30

WEM = Tray installation dim. (000)
M = installation dimension Centre glass (001)
Please always specify when ordering.

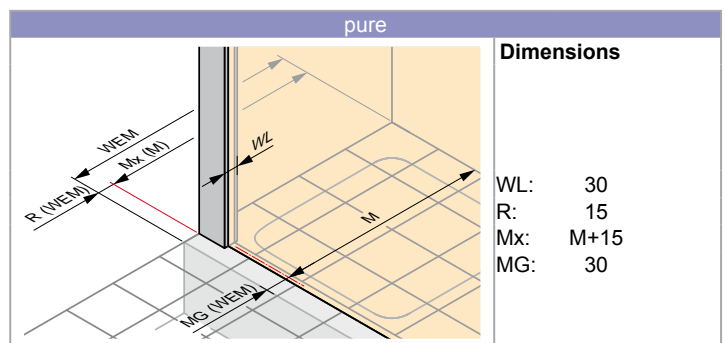

Dimensions

- WL: 30
- R: 15
- Mx: M+15
- MG: 30

WEM = Tray installation dim. (000)
M = installation dimension Centre glass (001)
Please always specify when ordering.

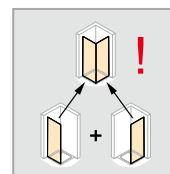
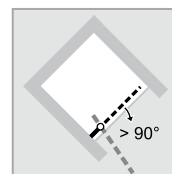
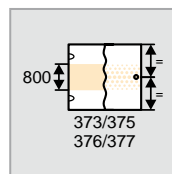
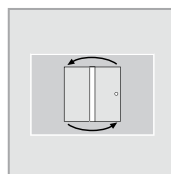
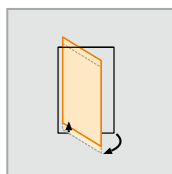
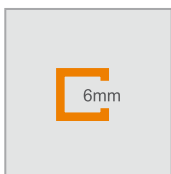

Swing door

Installation on shower tray recommended

Height	Model	WEM STN	WEM STS/STE	M (middle of glass) STN	M (middle of glass) STS/STE	Entry width STN/STS	Entry width STE	elegance	pure	Base price
1900	780	765-795	765-780	765-795	735-750	665	932	8E0610	8P0610	737,-
	800	785-815	785-800	785-815	755-770	685	960	8E0601	8P0601	
	880	865-895	865-880	865-895	835-850	765	1072	8E0611	8P0611	
	900	885-915	885-900	885-915	855-870	785	1100	8E0602	8P0602	
	980	965-995	965-980	965-995	935-950	865	1214	8E0612	8P0612	766,-
1000	985-1015	985-1000	985-1015	955-970	885	1242	8E0603	8P0603		
2000	780	765-795	765-780	765-795	735-750	665	932	8E0613	8P0613	811,-
	800	785-815	785-800	785-815	755-770	685	960	8E0604	8P0604	
	880	865-895	865-880	865-895	835-850	765	1072	8E0614	8P0614	
	900	885-915	885-900	885-915	855-870	785	1100	8E0605	8P0605	
	980	965-995	965-980	965-995	935-950	865	1214	8E0615	8P0615	844,-
1000	985-1015	985-1000	985-1015	955-970	885	1242	8E0606	8P0606		

NOTE: The complete corner entry consists of two item nos.

Floor-flush installation recommended

Height	Model	M (middle of glass) STS/STE (not possible for STN)	elegance	pure	Base price
2000	800	792-807	8E0607	8P0607	811,-
	900	892-907	8E0608	8P0608	
	1000	992-1007	8E0609	8P0609	844,-

Made-to-measure

Height	Width B	elegance	pure	Base price
1400-2000	500-1100	8E0680	8P0680	957,-



Adjustment range STN = dimensions - 8mm / + 22mm

Adjustment range STS/STE = dimensions - 8mm / + 7mm

Slopes and cut-outs

Slopes and cut-outs	Extra charges
	Supplement per slope/cut-out for made-to-measure 170,-

Dim. Range: min. - max.

	
1400-2000	500-1100

Extras

Height	Profile	elegance	pure	Price
1900	Extension profile, 15mm	8E2501	8P2501	32,-
	Extension profile, 15mm, for recess doors (handle side)	8E4301	8P4301	
	Profile for recess installation	8E2601	8P2601	119,-
2000	Extension profile, 15mm	8E2502	8P2502	32,-
	Extension profile, 15mm, for recess doors (handle side)	8E4302	8P4302	
	Profile for recess installation	8E2602	8P2602	119,-
	Inwards/outwards opening supplement set (can be shortened on site). Only suitable for 6mm door and side panel.	ZB0001	ZB0001	
	Inwards/outwards opening supplement set (can be shortened on site). Only suitable for 6mm door and 8mm side panel.	ZB0002	ZB0002	
to 2000	Profile for recess installation, made-to-measure	8E2680	8P2680	

Colours - Panel options

Profile colours	Colour code	Extra charges	Panel options		without Anti-Plaque		with Anti-Plaque	
			Glass code	Extra charges	Glass code	Extra charges		
White	055	0,-	Clear	321	0,-	322	209,-	
Matt silver	087		Grey	301		368		
Black	023	156,-	Bronze	341		378		
Grey/brown	061		Sand Plus	315	186,-	316	395,-	
Silver high-gloss	092		Privatima	373		375		
			Bubbles	376		377		
			Mirror glass	380	439,-	381	648,-	

HÜPPE Design pure

Profile colours	Colour code	Extra charges
Black Edition	123	171,-

HÜPPE Design elegance Rectangular

HÜPPE Design pure Rectangular

elegance



pure

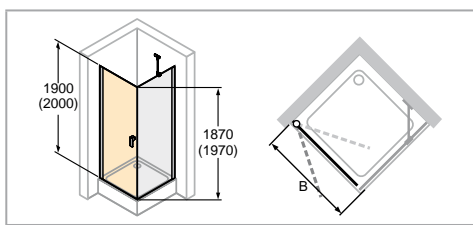

STS = ST + SW

! Recess profile is required for combining door with shortened side panel.

- Mirror glass (380/381): Please state in your order which segment should be produced with mirror glass. If this is not stated, the entire unit will be produced with mirror glass.
- For technical information, see Profile Colours and Panel Options section.

elegance

Dimensions

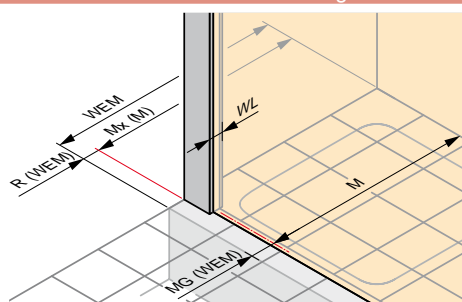

WL: 28
R: 15
Mx: M+15
MG: 30

WEM = Tray installation dim. (000)
M = installation dimension Centre glass (001)
Please always specify when ordering.

pure

Dimensions

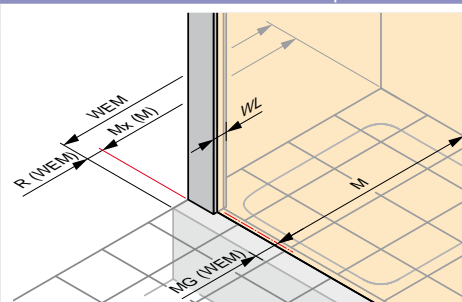

WL: 30
R: 15
Mx: M+15
MG: 30

WEM = Tray installation dim. (000)
M = installation dimension Centre glass (001)
Please always specify when ordering.

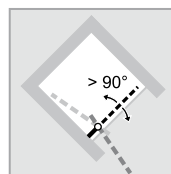
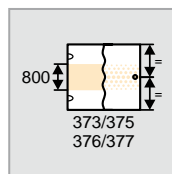
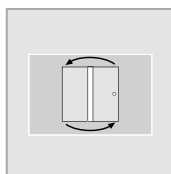
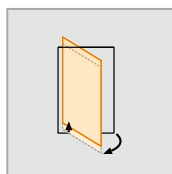
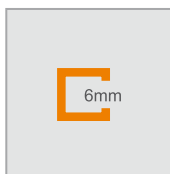

Swing door opening inwards/outwards for combination with side panel

Installation on shower tray recommended

Height	Model	WEM STS	M (middle of glass) STS	Entry width STS	elegance	pure	Base price
1900	800	785-800	755-770	685	8E0616	8P0616	737,-
	900	885-900	855-870	785	8E0617	8P0617	
	1000	985-1000	955-970	885	8E0618	8P0618	766,-
2000	800	785-800	755-770	685	8E0619	8P0619	811,-
	900	885-900	855-870	785	8E0620	8P0620	
	1000	985-1000	955-970	885	8E0621	8P0621	844,-

Floor-flush installation recommended

Height	Model	M (middle of glass)	elegance	pure	Base price
2000	800	792-807	8E0622	8P0622	811,-
	900	892-907	8E0623	8P0623	
	1000	992-1007	8E0624	8P0624	844,-

Made-to-measure

Height	Width B	elegance	pure	Base price
1400-2000	500-1100	8E0681	8P0681	957,-

Adjustment range = dimensions - 8mm / + 7mm

Slopes and cut-outs

Slopes and cut-outs	Extra charges
	Supplement per slope/cut-out for made-to-measure 170,-

Dim. Range: min. - max.

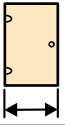
	
1400-2000	500-1100

Extras

Height	Profile	elegance	pure	Price
1900		8E2501	8P2501	32,-
2000		8E2502	8P2502	

Colours - Panel options

Profile colours	Colour code	Extra charges	Panel options	without Anti-Plaque		with Anti-Plaque	
				Glass code	Extra charges	Glass code	Extra charges
White	055	0,-	Clear	321	0,-	322	209,-
Matt silver	087		Grey	301		368	
Black	023		Bronze	341		378	
Grey/brown	061		Sand Plus	315	186,-	316	395,-
Silver high-gloss	092		Privatima	373		375	
HÜPPE Design pure			Bubbles	376		377	
Profile colours			Mirror glass	380	439,-	381	648,-
Colour code							
Extra charges							
Black Edition	123	171,-					

HÜPPE Design elegance Rectangular

HÜPPE Design pure Rectangular

elegance



pure

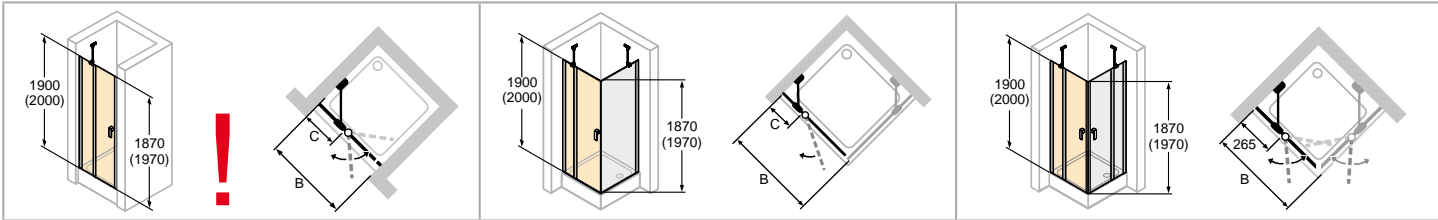

STN with fixed segment = ST with fixed segment + supplement set

STS with fixed segment = ST with fixed segment + SW

STE with fixed segment = 2 x ST with fixed segment

Standard model:

C = 261-276 / 461-476 (ST 1200)

! Recess profile is required for swing doors in recess or door combined with shortened side panel.

Glass 373/375 Privatima: Specification in the order whether left-hand or right-hand fixing.

- STS: Only outwards opening. Inwards opening also possible with inwards/outwards opening supplement set.
- Sloping sections possible. For recess solutions always with straight cut profile on closing side.
- Mirror glass (380/381): Please state in your order which segment should be produced with mirror glass. If this is not stated, the entire unit will be produced with mirror glass.
- For technical information, see Profile Colours and Panel Options section.

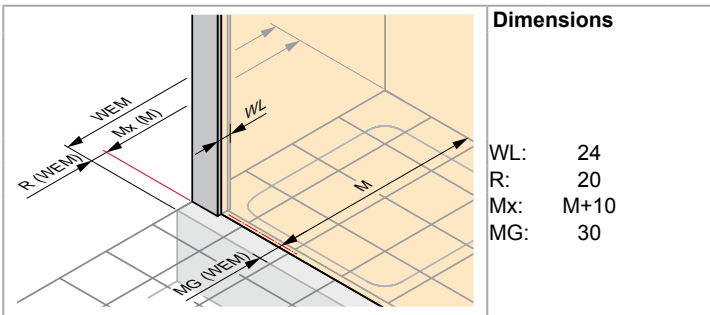

Dimensions

- WL: 24
- R: 20
- Mx: M+10
- MG: 30

WEM = Tray installation dim. (000)
 M = installation dimension Centre glass (001)
 Please always specify when ordering.

Swing door with fixed panel

Installation on shower tray recommended

Height	Model	WEM STN	WEM STS/STE	M (middle of glass) STN	M (middle of glass) STS/STE	Entry width STN/STS	Entry width STE	elegance	pure	Base price
1900	780	765-795	765-780	765-795	735-750	450	627	8E0710	8P0710	737,-
	800	785-815	785-800	785-815	755-770	470	655	8E0701	8P0701	
	880	865-895	865-880	865-895	835-850	550	771	8E0711	8P0711	
	900	885-915	885-900	885-915	855-870	570	799	8E0702	8P0702	766,-
	980	965-995	965-980	965-995	935-950	650	912	8E0712	8P0712	
	1000	985-1015	985-1000	985-1015	955-970	670	940	8E0703	8P0703	
1200	1185-1215	1185-1200	1185-1215	1155-1170	670	940	8E0725	8P0725	794,-	
2000	780	765-795	765-780	765-795	735-750	450	627	8E0713	8P0713	811,-
	800	785-815	785-800	785-815	755-770	470	655	8E0704	8P0704	
	880	865-895	865-880	865-895	835-850	550	771	8E0714	8P0714	
	900	885-915	885-900	885-915	855-870	570	799	8E0705	8P0705	844,-
	980	965-995	965-980	965-995	935-950	650	912	8E0715	8P0715	
	1000	985-1015	985-1000	985-1015	955-970	670	940	8E0706	8P0706	
1200	1185-1215	1185-1200	1185-1215	1155-1170	670	940	8E0726	8P0726	876,-	

NOTE: The complete corner entry consists of two item nos.

Made-to-measure

Height	Width B	Width C	elegance	pure	Base price
1400-2000	700-1550	230-600	8E0780	8P0780	957,-

Adjustment range STN = dimensions - 8mm / + 22mm





Adjustment range STS/STE = dimensions - 8mm / + 7mm

From widths of 1300mm with cross bar, side panel max. 1100mm.

Slopes and cut-outs

Slopes and cut-outs	Extra charges
 Supplement per slope/cut-out for made-to-measure	170,-

Dim. Range: min. - max.

			
1400-2000	700-1550	230-600	max. 900

Extras

Height	Profile	elegance	pure	Price
1900	Extension profile, 15mm	8E4201	8P4201	32,-
	Extension profile, 15mm, for recess doors (handle side)	8E4301	8P4301	
	Profile for recess installation	8E2601	8P2601	119,-
2000	Extension profile, 15mm	8E4202	8P4202	32,-
	Extension profile, 15mm, for recess doors (handle side)	8E4302	8P4302	
	Profile for recess installation	8E2602	8P2602	119,-
	Inwards/outwards opening supplement set (can be shortened on site). Only suitable for 6mm door and side panel.	ZB0001	ZB0001	
	Inwards/outwards opening supplement set (can be shortened on site). Only suitable for 6mm door and 8mm side panel.	ZB0002	ZB0002	
to 2000	Profile for recess installation, made-to-measure	8E2680	8P2680	

Colours - Panel options

Profile colours			Panel options				
	Colour code	Extra charges	without Anti-Plaque		with Anti-Plaque		
			Glass code	Extra charges	Glass code	Extra charges	
White	055	0,-	Clear	321	0,-	322	209,-
Matt silver	087		Grey	301		368	
Black	023		Bronze	341		378	
Grey/brown	061	156,-	Sand Plus	315	186,-	316	395,-
Silver high-gloss	092		Privatima	373		375	
			Bubbles	376		377	
			Mirror glass	380	439,-	381	648,-

HÜPPE Design pure

Profile colours	Colour code	Extra charges
Black Edition	123	171,-

HÜPPE Design elegance Rectangular

HÜPPE Design pure Rectangular

elegance



pure

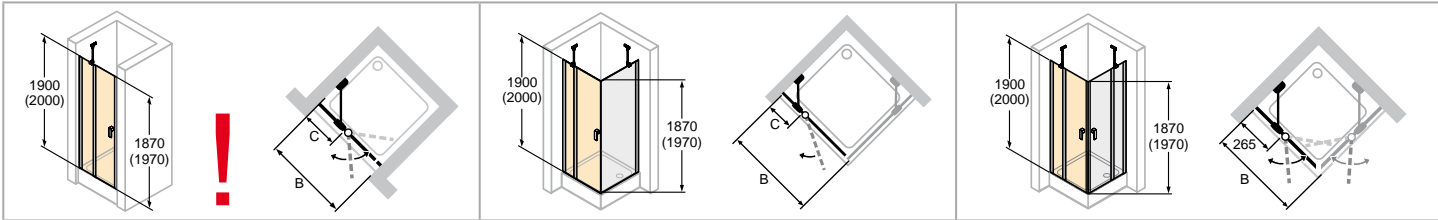

STN with fixed segment = ST with fixed segment + supplement set

STS with fixed segment = ST with fixed segment + SW

STE with fixed segment = 2 x ST with fixed segment

Standard model:

C = 261-276 / 461-476 (ST 1200)

! Recess profile is required for swing doors in recess or door combined with shortened side panel.

Glass 373/375 Privatima: Specification in the order whether left-hand or right-hand fixing.

- STS: Only outwards opening. Inwards opening also possible with inwards/outwards opening supplement set.
- Sloping sections possible. For recess solutions always with straight cut profile on closing side.
- Mirror glass (380/381): Please state in your order which segment should be produced with mirror glass. If this is not stated, the entire unit will be produced with mirror glass.
- For technical information, see Profile Colours and Panel Options section.

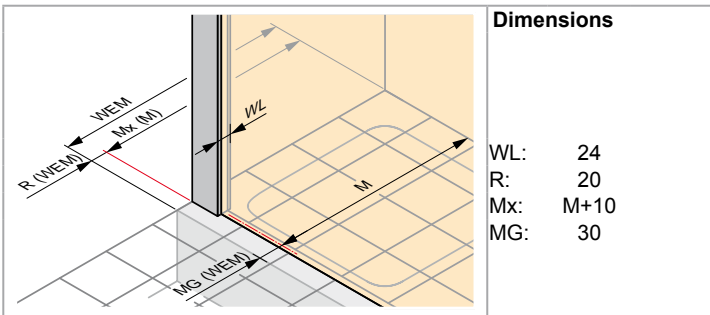

Dimensions

- WL: 24
- R: 20
- Mx: M+10
- MG: 30

WEM = Tray installation dim. (000)
M = installation dimension Centre glass (001)
Please always specify when ordering.

Swing door with fixed panel

Floor-flush installation recommended

Height	Model	M (middle of glass) STS/STE (not possible for STN)	elegance	pure	Base price
2000	800	792-807	8E0707	8P0707	811,-
	900	892-907	8E0708	8P0708	
	1000	992-1007	8E0709	8P0709	844,-
	1200	1192-1207	8E0727	8P0727	876,-

Made-to-measure

Height	Width B	Width C	elegance	pure	Base price
1400-2000	700-1550	230-600	8E0780	8P0780	957,-

Adjustment range STN = dimensions - 8mm / + 22mm

Adjustment range STS/STE = dimensions - 8mm / + 7mm

From widths of 1300mm with cross bar, side panel max. 1100mm.

Slopes and cut-outs

Slopes and cut-outs	Extra charges
 Supplement per slope/cut-out for made-to-measure	170,-

Dim. Range: min. - max.

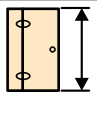
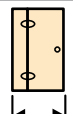
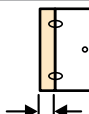
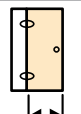
			
1400-2000	700-1550	230-600	max. 900

Extras

Height	Profile	elegance	pure	Price
1900	Extension profile, 15mm	8E4201	8P4201	32,-
	Extension profile, 15mm, for recess doors (handle side)	8E4301	8P4301	
	Profile for recess installation	8E2601	8P2601	119,-
2000	Extension profile, 15mm	8E4202	8P4202	32,-
	Extension profile, 15mm, for recess doors (handle side)	8E4302	8P4302	
	Profile for recess installation	8E2602	8P2602	119,-
	Inwards/outwards opening supplement set (can be shortened on site). Only suitable for 6mm door and side panel.	ZB0001	ZB0001	
	Inwards/outwards opening supplement set (can be shortened on site). Only suitable for 6mm door and 8mm side panel.	ZB0002	ZB0002	
to 2000	Profile for recess installation, made-to-measure	8E2680	8P2680	

Colours - Panel options

Profile colours	Colour code	Extra charges
White	055	0,-
Matt silver	087	
Black	023	156,-
Grey/brown	061	
Silver high-gloss	092	

HÜPPE Design pure

Profile colours	Colour code	Extra charges
Black Edition	123	171,-

Panel options	without Anti-Plaque		with Anti-Plaque	
	Glass code	Extra charges	Glass code	Extra charges
Clear	321	0,-	322	209,-
Grey	301	186,-	368	395,-
Bronze	341		378	
Sand Plus	315		316	
Privatima	373	439,-	375	648,-
Bubbles	376		377	
Mirror glass	380		381	

HÜPPE Design elegance Rectangular

HÜPPE Design pure Rectangular

elegance



pure

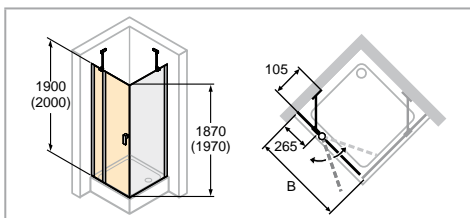

STS with fixed segment = ST with fixed segment + SW

! Recess profile is required for combining door with shortened side panel.

Glass 373/375 Privatima: Specification in the order whether left-hand or right-hand fixing.

- Mirror glass (380/381): Please state in your order which segment should be produced with mirror glass. If this is not stated, the entire unit will be produced with mirror glass.
- For technical information, see Profile Colours and Panel Options section.

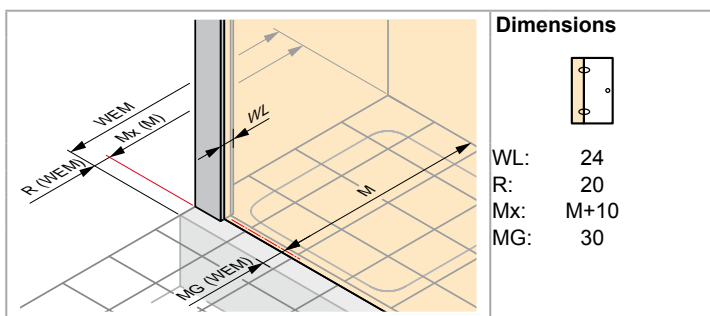

WEM = Tray installation dim. (000)

M = installation dimension Centre glass (001)

Please always specify when ordering.

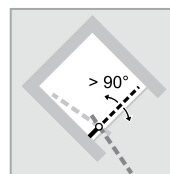
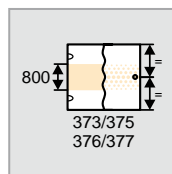
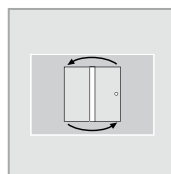
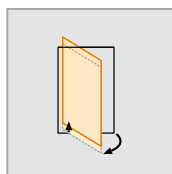
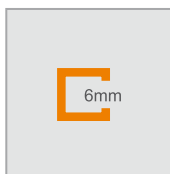

Swing door with fixed segments opening inwards/outwards for combination with side panel

Installation on shower tray recommended

Height	Model	WEM STS	M (middle of glass) STS	Entry width STS	elegance	pure	Base price
1900	800	785-800	755-770	470	8E0716	8P0716	737,-
	900	885-900	855-870	570	8E0717	8P0717	
	1000	985-1000	955-970	670	8E0718	8P0718	766,-
2000	800	785-800	755-770	470	8E0719	8P0719	811,-
	900	885-900	855-870	570	8E0720	8P0720	
	1000	985-1000	955-970	670	8E0721	8P0721	844,-

Floor-flush installation recommended

Height	Model	M (middle of glass)	elegance	pure	Base price
2000	800	792-807	8E0722	8P0722	811,-
	900	892-907	8E0723	8P0723	
	1000	992-1007	8E0724	8P0724	844,-

Made-to-measure

Height	Width B	elegance	pure	Base price
1400-2000	700-1550	8E0781	8P0781	957,-

Adjustment range = dimensions - 8mm / + 7mm





From widths of 1300mm with cross bar.

If more than 1300mm wide, side panel max. 1100mm.

Slopes and cut-outs

Slopes and cut-outs	Extra charges
 Supplement per slope/cut-out for made-to-measure	170,-

Dim. Range: min. - max.

			
1400-2000	700-1550	230-600	max. 900

Extras

Height	Profile	elegance	pure	Price
1900	Extension profile, 15mm	8E4201	8P4201	32,-
2000	Extension profile, 15mm	8E4202	8P4202	
to 2000	Profile for recess installation, made-to-measure	8E2602	8P2602	119,-
		8E2680	8P2680	

Colours - Panel options

Profile colours	Colour code	Extra charges	Panel options		without Anti-Plaque		with Anti-Plaque	
			Glass code	Extra charges	Glass code	Extra charges		
White	055	0,-	Clear	321	0,-	322	209,-	
Matt silver	087		Grey	301		368		
Black	023		Bronze	341		378		
Grey/brown	061		Sand Plus	315	186,-	316	395,-	
Silver high-gloss	092		Privatima	373		375		
HÜPPE Design pure			Bubbles	376		377		
Profile colours			Mirror glass	380	439,-	381	648,-	
Black Edition								
	123	171,-						

HÜPPE Design pure Rectangular

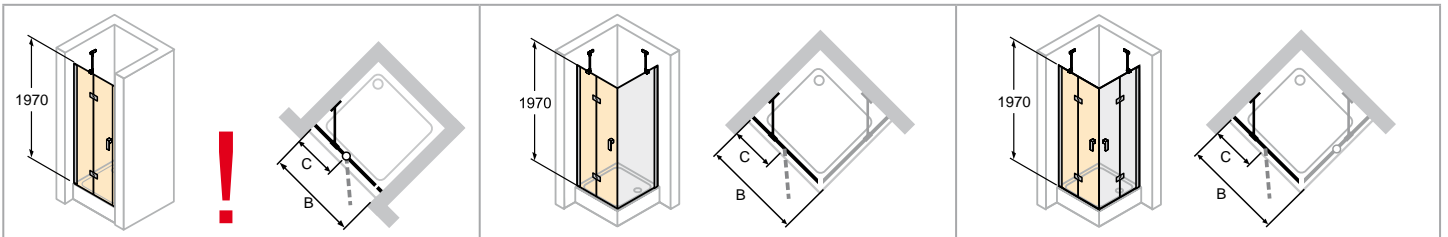

STN with fixed segment = ST with fixed segment + supplement set

STS with fixed segment = ST with fixed segment + SW

STE with fixed segment = 2 x ST with fixed segment

! Note: Recess profile is required for swing doors in recess or door combined with shortened side panel. See Extras

• Glass 373/375 Privatima: Specification in the order whether left-hand or right-hand fixing.

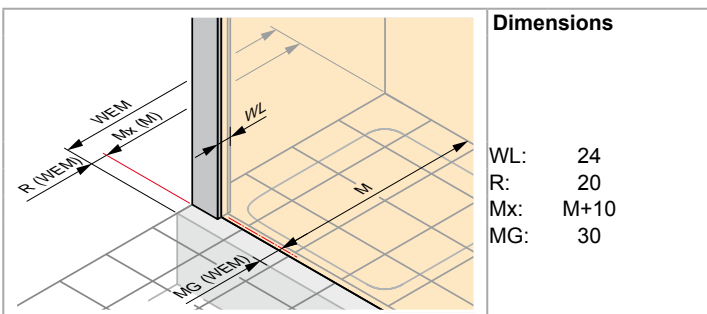

WEM = Tray installation dim. (000)
M = installation dimension Centre glass (001)
Please always specify when ordering.

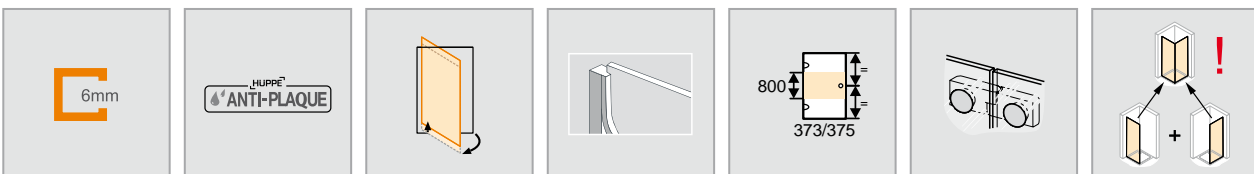

Swing door with fixed segment and fitting

Left-hand fixing

Installation on shower tray recommended

Height	Model	WEM STN	WEM STS/STE	M (middle of glass) STN	M (middle of glass) STS/STE	Entry width STN/STS	Entry width STE	Width of fixed segment C	pure	Base price
1970	750	735-760	735-750	735-760	705-720	452	644	245-260	8P9001	791,-
	800	785-810	785-800	785-810	755-770	472	673	265-280	8P9002	
	900	885-910	885-900	885-910	855-870	572	814	265-280	8P9003	
	1000	985-1010	985-1000	985-1010	955-970	672	814	365-380	8P9004	823,-
	1200	1185-1210	1185-1200	1185-1210	1155-1170	672	950	465-480	8P9005	855,-

NOTE: The complete corner entry consists of two item nos.

Left-hand fixing

Floor-flush installation recommended

Height	Model	M (middle of glass) STS/STE	Entry width STS	Entry width STE	Width of fixed segment C	pure	Base price
1970	750	742-757	452	644	275-290	8P9011	791,-
	800	792-807	472	673	295-310	8P9012	
	900	892-907	572	814	295-310	8P9013	
	1000	992-1007	672	814	395-410	8P9014	823,-
	1200	1192-1207	672	950	495-510	8P9015	855,-

NOTE: The complete corner entry consists of two item nos.

Made-to-measure - Left-hand fixing





Height	Width B	Width C	pure	Base price
1200-2000	700-1200	200-600	8P9080	934,-

Adjustment range = dimensions - 8mm / + 7mm

Slopes and cut-outs

Slopes and cut-outs	Extra charges
	Supplement per slope/cut-out for made-to-measure 170,-

Dim. Range: min. - max.

			
1200-2000	700-1200	200-600	max. 900

Extras

Height	Profile	pure	Price
1970	Extension profile, 15mm	8P9901	32,-
	Extension profile, 15mm, for recess doors (handle side)	8P9903	
	Profile for recess installation	8P9904	119,-
1500-2000	Profile for recess installation, made-to-measure	8P9980	

Colours - Panel options

Profile colours	Colour code	Extra charges	Panel options		without Anti-Plaque		with Anti-Plaque	
			Glass code	Extra charges	Glass code	Extra charges		
Matt silver	087	0,-	Clear	321	0,-	322	209,-	
Silver high-gloss	092	156,-	Privatima	373	186,-	375	395,-	
Black Edition	123	171,-						

HÜPPE Design pure Rectangular

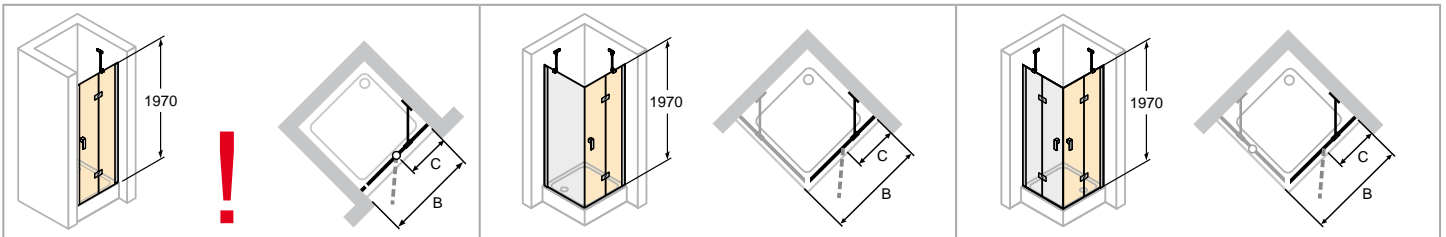

STN with fixed segment = ST with fixed segment + supplement set

STS with fixed segment = ST with fixed segment + SW

STE with fixed segment = 2 x ST with fixed segment

! Note: Recess profile is required for swing doors in recess or door combined with shortened side panel. See Extras

• Glass 373/375 Privatima: Specification in the order whether left-hand or right-hand fixing.

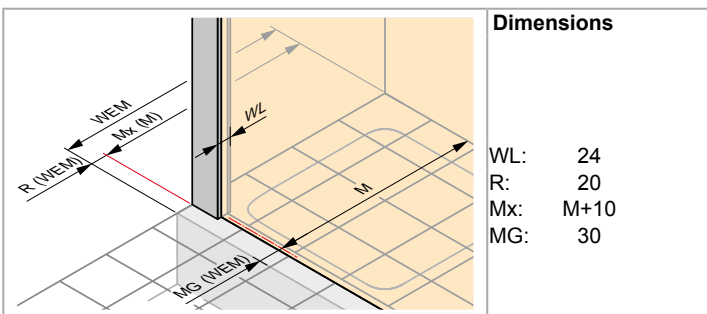

Dimensions

- WL: 24
- R: 20
- Mx: M+10
- MG: 30

WEM = Tray installation dim. (000)
 M = installation dimension Centre glass (001)
 Please always specify when ordering.

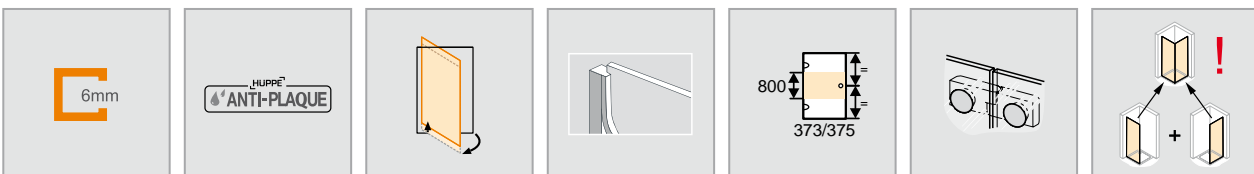

Swing door with fixed segment and fitting

Right-hand fixing

Installation on shower tray recommended

Height	Model	WEM STN	WEM STS/STE	M (middle of glass) STN	M (middle of glass) STS/STE	Entry width STN/STS	Entry width STE	Width of fixed segment C	pure	Base price
1970	750	735-760	735-750	735-760	705-720	452	644	245-260	8P9101	791,-
	800	785-810	785-800	785-810	755-770	472	673	265-280	8P9102	
	900	885-910	885-900	885-910	855-870	572	814	265-280	8P9103	
	1000	985-1010	985-1000	985-1010	955-970	672	814	365-380	8P9104	823,-
	1200	1185-1210	1185-1200	1185-1210	1155-1170	672	950	465-480	8P9105	855,-

NOTE: The complete corner entry consists of two item nos.

Right-hand fixing

Floor-flush installation recommended

Height	Model	M (middle of glass) STS/STE	Entry width STS	Entry width STE	Width of fixed segment C	pure	Base price
1970	750	742-757	452	644	275-290	8P9111	791,-
	800	792-807	472	673	295-310	8P9112	
	900	892-907	572	814	295-310	8P9113	
	1000	992-1007	672	814	395-410	8P9114	823,-
	1200	1192-1207	672	950	495-510	8P9115	855,-

NOTE: The complete corner entry consists of two item nos.

Made-to-measure - Right-hand fixing





Height	Width B	Width C	pure	Base price
1200-2000	700-1200	200-600	8P9180	934,-

Adjustment range = dimensions - 8mm / + 7mm

Slopes and cut-outs

Slopes and cut-outs	Extra charges
	Supplement per slope/cut-out for made-to-measure 170,-

Dim. Range: min. - max.

			
1200-2000	700-1200	200-600	max. 900

Extras

Height	Profile	pure	Price
1970	Extension profile, 15mm	8P9901	32,-
	Extension profile, 15mm, for recess doors (handle side)	8P9903	
	Profile for recess installation	8P9904	119,-
1500-2000	Profile for recess installation, made-to-measure	8P9980	

Colours - Panel options

Profile colours	Colour code	Extra charges	Panel options		without Anti-Plaque		with Anti-Plaque	
			Glass code	Extra charges	Glass code	Extra charges		
Matt silver	087	0,-	Clear	321	0,-	322	209,-	
Silver high-gloss	092	156,-	Privatima	373	186,-	375	395,-	
Black Edition	123	171,-						

HÜPPE Design elegance Rectangular

HÜPPE Design pure Rectangular

elegance



pure

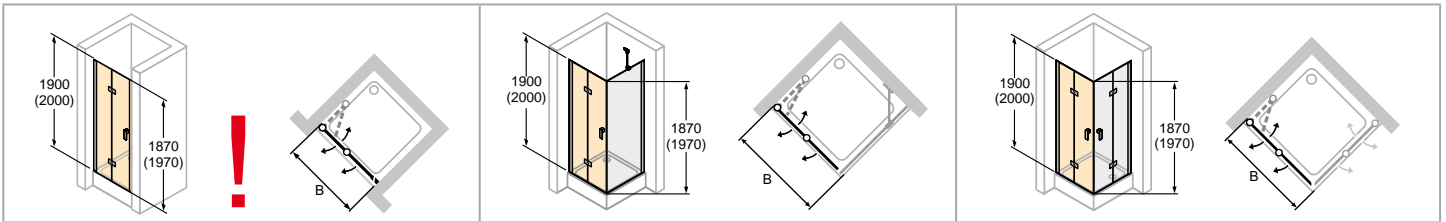

SFTN =

SFT + profile for recess installation

SFTS = SFT + SW

SFTE = 2 x SFT

! Recess profile is required for folding swing doors in recess or door combined with shortened side panel.

- Sloping sections possible. For recess solutions always with straight cut profile on closing side.
- Mirror glass (380/381): Please state in your order which segment should be produced with mirror glass. If this is not stated, the entire unit will be produced with mirror glass.
- For technical information, see Profile Colours and Panel Options section.

elegance

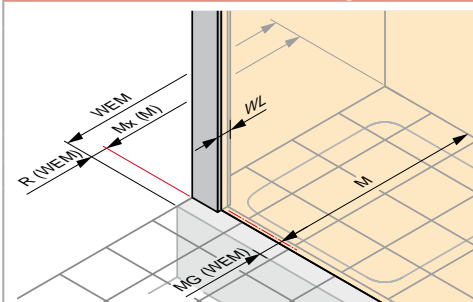

Dimensions

WL: 28
R: 15
Mx: M+15
MG: 30

WEM = Tray installation dim. (000)
M = installation dimension Centre glass (001)
Please always specify when ordering.

pure

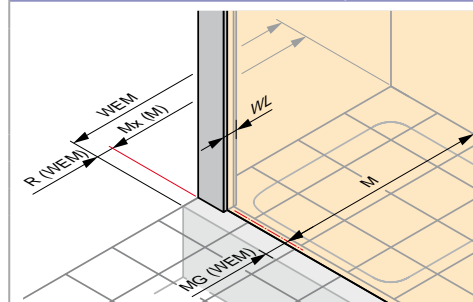

Dimensions

WL: 30
R: 15
Mx: M+15
MG: 30

WEM = Tray installation dim. (000)
M = installation dimension Centre glass (001)
Please always specify when ordering.

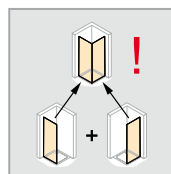
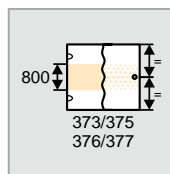
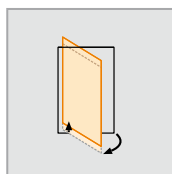
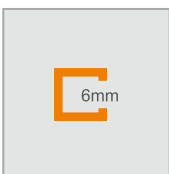

Folding swing door

Left-hand fixing

Installation on shower tray recommended

Height	Model	WEM SFTN	WEM SFTS/SFTE	M (middle of glass) SFTN	M (middle of glass) SFTS/SFTE	Entry width SFTS/SFTN	Entry width SFTE	elegance	pure	Base price
1900	700	685-715	685-700	685-715	655-670	560	800	8E0801	8P0801	848,-
	750	735-765	735-750	735-765	705-720	610	870	8E0802	8P0802	
	800	785-815	785-800	785-815	755-770	660	950	8E0803	8P0803	
	900	885-915	885-900	885-915	855-870	760	1100	8E0804	8P0804	
	1000	985-1015	985-1000	985-1015	955-970	860	1240	8E0805	8P0805	882,-
	1200	1185-1215	1185-1200	1185-1215	1155-1170	1060	1380	8E0806	8P0806	899,-
2000	700	685-715	685-700	685-715	655-670	560	800	8E0807	8P0807	933,-
	750	735-765	735-750	735-765	705-720	610	870	8E0808	8P0808	
	800	785-815	785-800	785-815	755-770	660	950	8E0809	8P0809	
	900	885-915	885-900	885-915	855-870	760	1100	8E0810	8P0810	
	1000	985-1015	985-1000	985-1015	955-970	860	1240	8E0811	8P0811	971,-
	1200	1185-1215	1185-1200	1185-1215	1155-1170	1060	1380	8E0812	8P0812	988,-

NOTE: The complete corner entry consists of two item nos.

Left-hand fixing

Floor-flush installation recommended

Height	Model	M (middle of glass) SFTS/SFTE (not possible for SFTN)	elegance	pure	Base price
2000	700	692-707	8E0813	8P0813	933,-
	750	742-757	8E0814	8P0814	
	800	792-807	8E0815	8P0815	
	900	892-907	8E0816	8P0816	
	1000	992-1007	8E0817	8P0817	971,-
	1200	1192-1207	8E0818	8P0818	988,-

Made-to-measure - Left-hand fixing

Height	Width B	elegance	pure	Base price
1400-2000	500-1250	8E0880	8P0880	1.101,-

Adjustment range SFTN = dimensions - 8mm / + 22mm



Adjustment range SFTS/SFTE = dimensions - 8mm / + 7mm

	Model	Folded width F	Profile thickness P	Model	Folded width F	Profile thickness P
	SFT 700	340	95-110	SFT 900	440	95-110
	SFT 750	365	95-110	SFT 1000	490	95-110
	SFT 800	390	95-110	SFT 1200	590	95-110

Slopes and cut-outs

Slopes and cut-outs	Extra charges
 Supplement per slope/cut-out for made-to-measure	170,-

Dim. Range: min. - max.

	
1400-2000	500-1250

Extras

Height	Profile	elegance	pure	Price
1900	Extension profile, 15mm	8E2501	8P2501	32,-
	Extension profile, 15mm, for recess doors (handle side)	8E4301	8P4301	
	Profile for recess installation	8E2601	8P2601	119,-
2000	Extension profile, 15mm	8E2502	8P2502	32,-
	Extension profile, 15mm, for recess doors (handle side)	8E4302	8P4302	
	Profile for recess installation	8E2602	8P2602	119,-
to 2000	Profile for recess installation, made-to-measure	8E2680	8P2680	

Colours - Panel options

Profile colours	Colour code	Extra charges	Panel options		without Anti-Plaque		with Anti-Plaque	
			Glass code	Extra charges	Glass code	Extra charges		
White	055	0,-	Clear	321	0,-	322	209,-	
Matt silver	087		Grey	301		368		
Black	023		Bronze	341		378		
Grey/brown	061		Sand Plus	315	186,-	316	395,-	
Silver high-gloss	092		Privatima	373		375		
HÜPPE Design pure			Bubbles	376		377		
Profile colours	Colour code	Extra charges	Mirror glass	380	439,-	381	648,-	
Black Edition	123	171,-						

HÜPPE Design elegance Rectangular

HÜPPE Design pure Rectangular

elegance



pure

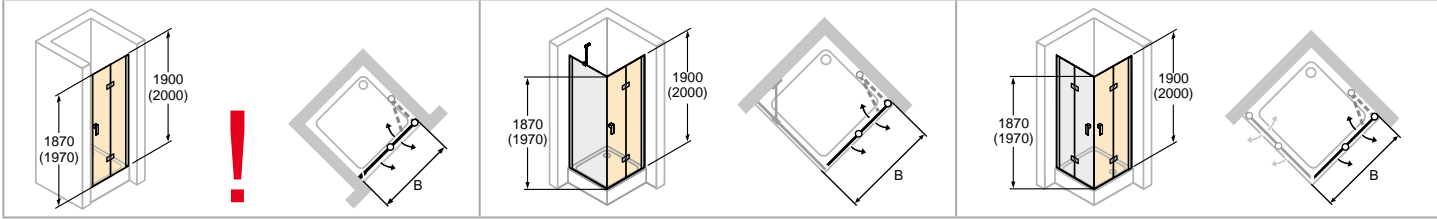

SFTN =
SFT + profile for recess installation

SFTS = SFT + SW

SFTE = 2 x SFT

! Recess profile is required for folding swing doors in recess or door combined with shortened side panel.

- Sloping sections possible. For recess solutions always with straight cut profile on closing side.
- Mirror glass (380/381): Please state in your order which segment should be produced with mirror glass. If this is not stated, the entire unit will be produced with mirror glass.
- For technical information, see Profile Colours and Panel Options section.

elegance

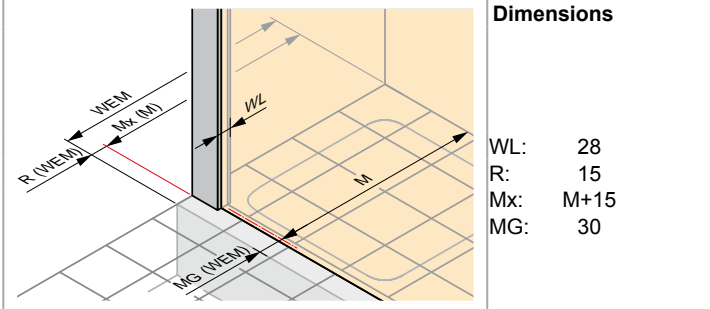

WEM = Tray installation dim. (000)
M = installation dimension Centre glass (001)
Please always specify when ordering.

pure

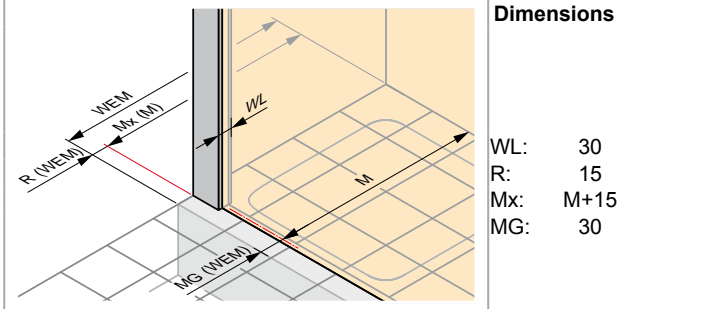

WEM = Tray installation dim. (000)
M = installation dimension Centre glass (001)
Please always specify when ordering.

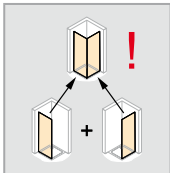
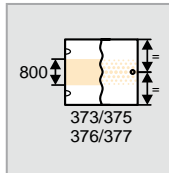
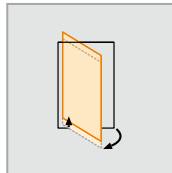
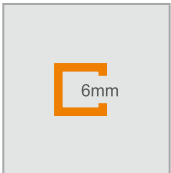

Folding swing door

Right-hand fixing

Installation on shower tray recommended

Height	Model	WEM SFTN	WEM SFTS/SFTE	M (middle of glass) SFTN	M (middle of glass) SFTS/SFTE	Entry width SFTS/SFTN	Entry width SFTE	elegance	pure	Base price
1900	700	685-715	685-700	685-715	655-670	560	800	8E0901	8P0901	848,-
	750	735-765	735-750	735-765	705-720	610	870	8E0902	8P0902	
	800	785-815	785-800	785-815	755-770	660	950	8E0903	8P0903	
	900	885-915	885-900	885-915	855-870	760	1100	8E0904	8P0904	
	1000	985-1015	985-1000	985-1015	955-970	860	1240	8E0905	8P0905	882,-
	1200	1185-1215	1185-1200	1185-1215	1155-1170	1060	1380	8E0906	8P0906	899,-
2000	700	685-715	685-700	685-715	655-670	560	800	8E0907	8P0907	933,-
	750	735-765	735-750	735-765	705-720	610	870	8E0908	8P0908	
	800	785-815	785-800	785-815	755-770	660	950	8E0909	8P0909	
	900	885-915	885-900	885-915	855-870	760	1100	8E0910	8P0910	
	1000	985-1015	985-1000	985-1015	955-970	860	1240	8E0911	8P0911	971,-
	1200	1185-1215	1185-1200	1185-1215	1155-1170	1060	1380	8E0912	8P0912	988,-

NOTE: The complete corner entry consists of two item nos.

Right-hand fixing

Floor-flush installation recommended

Height	Model	M (middle of glass) SFTS/SFTE (not possible for SFTN)	elegance	pure	Base price
2000	700	692-707	8E0913	8P0913	933,-
	750	742-757	8E0914	8P0914	
	800	792-807	8E0915	8P0915	
	900	892-907	8E0916	8P0916	
	1000	992-1007	8E0917	8P0917	971,-
	1200	1192-1207	8E0918	8P0918	988,-

Made-to-measure - Right-hand fixing

Height	Width B	elegance	pure	Base price
1400-2000	500-1250	8E0980	8P0980	1.101,-

Adjustment range SFTN = dimensions - 8mm / + 22mm



Adjustment range SFTS/SFTE = dimensions - 8mm / + 7mm

	Model	Folded width F	Profile thickness P	Model	Folded width F	Profile thickness P
	SFT 700	340	95-110	SFT 900	440	95-110
	SFT 750	365	95-110	SFT 1000	490	95-110
	SFT 800	390	95-110	SFT 1200	590	95-110

Slopes and cut-outs

Slopes and cut-outs	Extra charges
 Supplement per slope/cut-out for made-to-measure	170,-

Dim. Range: min. - max.

	
1400-2000	500-1250

Extras

Height	Profile	elegance	pure	Price
1900	Extension profile, 15mm	8E2501	8P2501	32,-
	Extension profile, 15mm, for recess doors (handle side)	8E4301	8P4301	
	Profile for recess installation	8E2601	8P2601	119,-
2000	Extension profile, 15mm	8E2502	8P2502	32,-
	Extension profile, 15mm, for recess doors (handle side)	8E4302	8P4302	
	Profile for recess installation	8E2602	8P2602	119,-
to 2000	Profile for recess installation, made-to-measure	8E2680	8P2680	119,-

Colours - Panel options

Profile colours	Colour code	Extra charges	Panel options		without Anti-Plaque		with Anti-Plaque	
			Glass code	Extra charges	Glass code	Extra charges		
White	055	0,-	Clear	321	0,-	322	209,-	
Matt silver	087		Grey	301		368		
Black	023		Bronze	341		378		
Grey/brown	061		Sand Plus	315	186,-	316	395,-	
Silver high-gloss	092		Privatima	373		375		
HÜPPE Design pure			Bubbles	376		377		
Profile colours	Colour code	Extra charges	Mirror glass	380	439,-	381	648,-	
Black Edition	123	171,-						

HÜPPE Design elegance Rectangular

HÜPPE Design pure Rectangular

pure

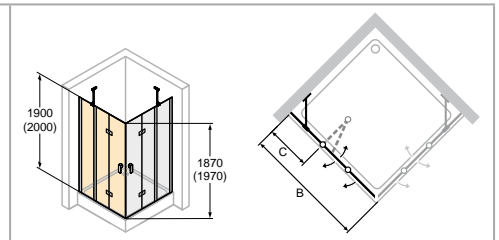
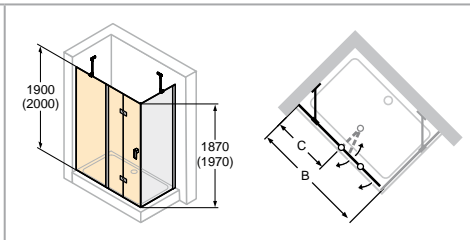
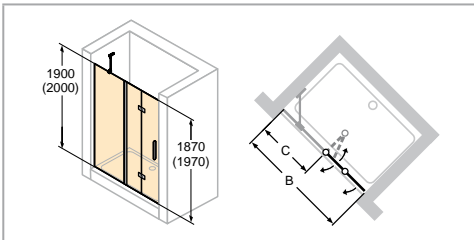

SFTN with fixed segment = SFT with fixed segment + supplement set

SFTS with fixed segment = SFT with fixed segment + SW

SFTE with fixed segment = 2 x SFT with fixed segment

! A recess profile is required for folding swing doors in recess or doors combined with shortened side panel.

- Sloping sections possible. For recess solutions always with straight cut profile on closing side.
- Mirror glass (380/381): Please state in your order which segment should be produced with mirror glass. If this is not stated, the entire unit will be produced with mirror glass.
- For technical information, see Profile Colours and Panel Options section.

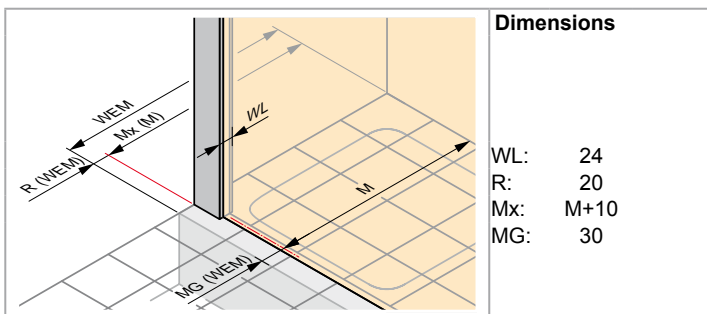

WEM = Tray installation dim. (000)
 M = installation dimension Centre glass (001)
 Please always specify when ordering.

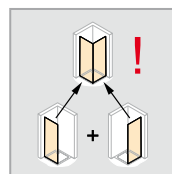
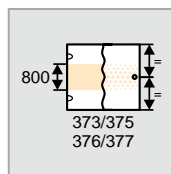
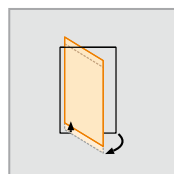
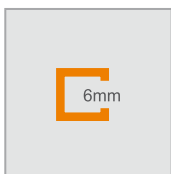

Folding swing door with fixed segment

Left-hand fixing

Height	Model	WEM SFTN mfS	WEM SFTS with fixed segments / SFTE with fixed segments	M (middle of glass) SFTN with fixed segment	M (middle of glass) SFTS with fixed segment / SFTE with fixed segment	Entry width SFTS with fixed segment/SFTN with fixed segment	Entry width SFTE with fixed segment	Width of fixed segment C	elegance	pure	Base price
1900	1200	1185-1215	1185-1200	1185-1215	1155-1170	750	1050	392-407	8E7001	8P7001	1.371,-
	1400	1385-1415	1385-1400	1385-1415	1355-1370	950	1320	392-407	8E7002	8P7002	1.397,-
	1700	1685-1715	1685-1700	1685-1715	1655-1670	1150	1600	492-507	8E7003	8P7003	1.607,-
2000	1200	1185-1215	1185-1200	1185-1215	1155-1170	750	1050	392-407	8E7004	8P7004	1.509,-
	1400	1385-1415	1385-1400	1385-1415	1355-1370	950	1320	392-407	8E7005	8P7005	1.539,-
	1700	1685-1715	1685-1700	1685-1715	1655-1670	1150	1600	492-507	8E7006	8P7006	1.769,-

NOTE: The complete corner entry consists of two item nos.

Made-to-measure - Left-hand fixing

Height	Width B	Door width	Width of fixed segment	elegance	pure	Base price
1400-2000	700-1200	max. 970	230-800	8E7080	8P7080	1.715,-
	1201-1600	max. 970	230-800	8E7081	8P7081	1.677,-
	1601-1800	max. 1150	230-800	8E7082	8P7082	1.845,-

Adjustment range SFTN with fixed segment = dimensions - 8mm / + 22mm

Adjustment range SFTS/SFTE with fixed segment = dimensions - 8mm / + 7mm

Slopes and cut-outs

Slopes and cut-outs	Extra charges
	Supplement per slope/cut-out for made-to-measure 170,-

Dim. Range: min. - max.

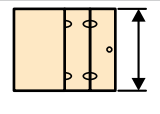
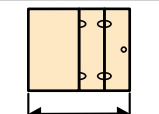
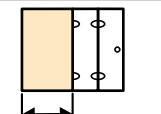
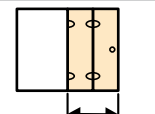
			
1400-2000	700-1800	230-800	max. 1150

Extras

Height	Profile	elegance	pure	Price
1900	Extension profile, 15mm	8E2501	8P2501	32,-
	Extension profile, 15mm, for recess doors (handle side)	8E4301	8P4301	
	Profile for recess installation	8E2601	8P2601	119,-
2000	Extension profile, 15mm	8E2502	8P2502	32,-
	Extension profile, 15mm, for recess doors (handle side)	8E4302	8P4302	
	Profile for recess installation	8E2602	8P2602	119,-
to 2000	Profile for recess installation, made-to-measure	8E2680	8P2680	

Colours - Panel options

Profile colours			Panel options			
	Colour code	Extra charges	without Anti-Plaque Glass code	Extra charges	with Anti-Plaque Glass code	Extra charges
White	055	0,-	Clear	321	322	418,-
Matt silver	087		Grey	301	368	789,-
Black	023		Bronze	341	378	
Grey/brown	061		Sand Plus	315	316	
Silver high-gloss	092		Privatima	373	375	
			Bubbles	376	377	
			Mirror glass	380	381	857,-

HÜPPE Design pure		
Profile colours	Colour code	Extra charges
Black Edition	123	342,-

HÜPPE Design elegance Rectangular

HÜPPE Design pure Rectangular

pure

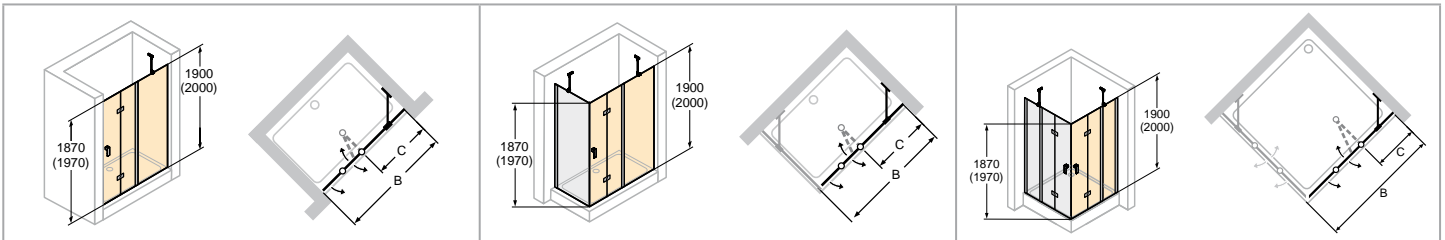

SFTN with fixed segment = SFT with fixed segment + supplement set

SFTS with fixed segment = SFT with fixed segment + SW

SFTE with fixed segment = 2 x SFT with fixed segment

! A recess profile is required for folding swing doors in recess or doors combined with shortened side panel.

- Sloping sections possible. For recess solutions always with straight cut profile on closing side.
- Mirror glass (380/381): Please state in your order which segment should be produced with mirror glass. If this is not stated, the entire unit will be produced with mirror glass.
- For technical information, see Profile Colours and Panel Options section.

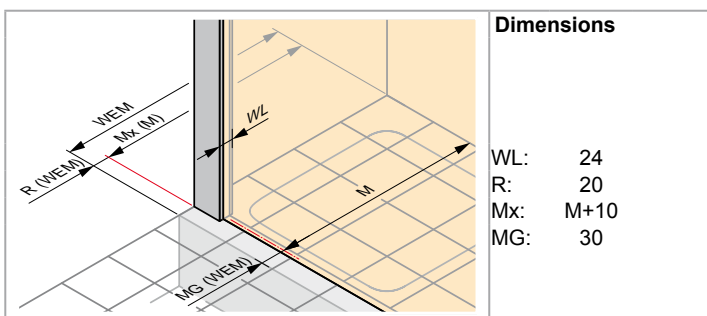

WEM = Tray installation dim. (000)
 M = installation dimension Centre glass (001)
 Please always specify when ordering.

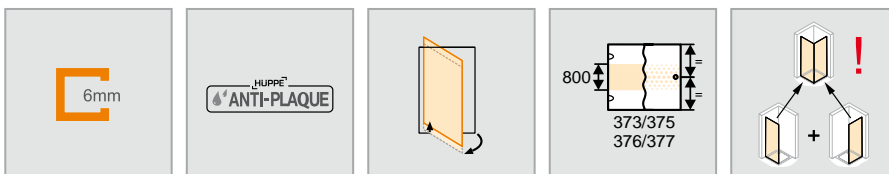

Folding swing door with fixed segment

Right-hand fixing

Height	Model	WEM SFTN mfs	WEM SFTS with fixed segments / SFTE with fixed segments	M (middle of glass) SFTN with fixed segment	M (middle of glass) SFTS with fixed segment / SFTE with fixed segment	Entry width SFTS with fixed segment/SFTN with fixed segment	Entry width SFTE with fixed segment	Width of fixed segment C	elegance	pure	Base price
1900	1200	1185-1215	1185-1200	1185-1215	1155-1170	750	1050	392-407	8E7101	8P7101	1.371,-
	1400	1385-1415	1385-1400	1385-1415	1355-1370	950	1320	392-407	8E7102	8P7102	1.397,-
	1700	1685-1715	1685-1700	1685-1715	1655-1670	1150	1600	492-507	8E7103	8P7103	1.607,-
2000	1200	1185-1215	1185-1200	1185-1215	1155-1170	750	1050	392-407	8E7104	8P7104	1.509,-
	1400	1385-1415	1385-1400	1385-1415	1355-1370	950	1320	392-407	8E7105	8P7105	1.539,-
	1700	1685-1715	1685-1700	1685-1715	1655-1670	1150	1600	492-507	8E7106	8P7106	1.769,-

NOTE: The complete corner entry consists of two item nos.

Made-to-measure - Right-hand fixing

Height	Width B	Door width	Width of fixed segment	elegance	pure	Base price
1400-2000	700-1200	max. 970	230-800	8E7180	8P7180	1.715,-
	1201-1600	max. 970	230-800	8E7181	8P7181	1.677,-
	1601-1800	max. 1150	230-800	8E7182	8P7182	1.845,-

Adjustment range SFTN with fixed segment = dimensions - 8mm / + 22mm

Adjustment range SFTS/SFTE with fixed segment = dimensions - 8mm / + 7mm

Slopes and cut-outs

Slopes and cut-outs	Extra charges
	Supplement per slope/cut-out for made-to-measure 170,-

Dim. Range: min. - max.

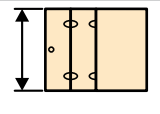
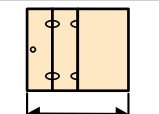
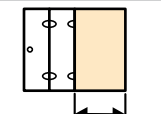
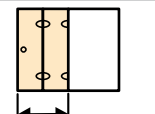
			
1400-2000	700-1800	230-800	max. 1150

Extras

Height	Profile	elegance	pure	Price
1900	Extension profile, 15mm	8E2501	8P2501	32,-
	Extension profile, 15mm, for recess doors (handle side)	8E4301	8P4301	
	Profile for recess installation	8E2601	8P2601	119,-
2000	Extension profile, 15mm	8E2502	8P2502	32,-
	Extension profile, 15mm, for recess doors (handle side)	8E4302	8P4302	
	Profile for recess installation	8E2602	8P2602	119,-
to 2000	Profile for recess installation, made-to-measure	8E2680	8P2680	

Colours - Panel options

Profile colours	Colour code	Extra charges	Panel options		without Anti-Plaque		with Anti-Plaque	
			Glass code	Extra charges	Glass code	Extra charges		
White	055	0,-	Clear	321	0,-	322	418,-	
Matt silver	087		Grey	301		368		
Black	023		Bronze	341		378		
Grey/brown	061		Sand Plus	315	371,-	316	789,-	
Silver high-gloss	092		Privatima	373		375		
HÜPPE Design pure			Bubbles	376		377		
Profile colours			Mirror glass	380	439,-	381	857,-	
Black Edition								
	123	342,-						

HÜPPE Design elegance Rectangular

HÜPPE Design pure Rectangular

elegance



pure

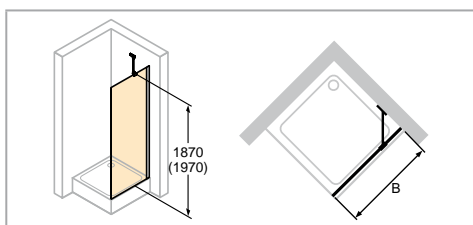

- Side panel can be combined with swing door, swing door with fixed segment, folding swing door and folding swing door with fixed segment.
- Shortened side panel can only be combined with door in recess. Niche installation kit required.
- Towel rail height can be selected individually and must be specified with the order. If nothing is specified, the towel rail is always delivered middle of glass (height and width).

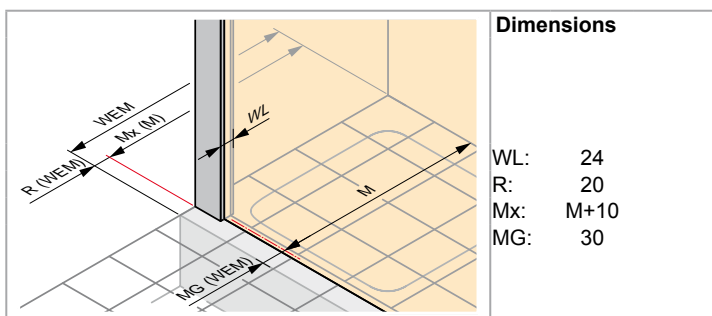

Dimensions

WL: 24
 R: 20
 Mx: M+10
 MG: 30

WEM = Tray installation dim. (000)
 M = installation dimension Centre glass (001)
 Please always specify when ordering.

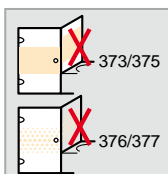
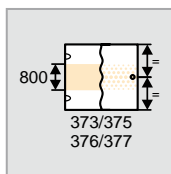
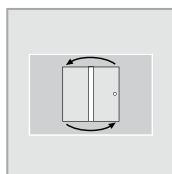
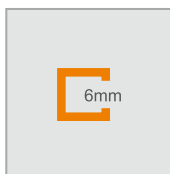

Side panel for swing door

Installation on shower tray recommended

Height	Model	WEM B	M (middle of glass) B	elegance	pure	Base price
1900	SW 700	685-700	655-670	8E1001	8P1001	517,-
	SW 750	735-750	705-720	8E1002	8P1002	
	SW 800	785-800	755-770	8E1003	8P1003	
	SW 900	885-900	855-870	8E1004	8P1004	
	SW 1000	985-1000	955-970	8E1005	8P1005	538,-
2000	SW 700	685-700	655-670	8E1010	8P1010	569,-
	SW 750	735-750	705-720	8E1011	8P1011	
	SW 800	785-800	755-770	8E1012	8P1012	
	SW 900	885-900	855-870	8E1013	8P1013	
	SW 1000	985-1000	955-970	8E1014	8P1014	591,-
1650	SWK 700	685-700	650-665	8E1006	8P1006	517,-
	SWK 750	735-750	700-715	8E1007	8P1007	
	SWK 800	785-800	750-765	8E1008	8P1008	
	SWK 900	885-900	850-865	8E1009	8P1009	
1750	SWK 700	685-700	650-665	8E1015	8P1015	517,-
	SWK 750	735-750	700-715	8E1016	8P1016	
	SWK 800	785-800	750-765	8E1017	8P1017	
	SWK 900	885-900	850-865	8E1018	8P1018	

Floor-flush installation recommended

Height	Model	M (middle of glass) B	elegance	pure	Base price
2000	SW 700	692-707	8E1019	8P1019	569,-
	SW 750	742-757	8E1020	8P1020	
	SW 800	792-807	8E1021	8P1021	
	SW 900	892-907	8E1022	8P1022	
	SW 1000	992-1007	8E1023	8P1023	591,-

Made-to-measure



Height	Model	Width B	Fixing	elegance	pure	Base price
500-2000	Standard made-to-measure	200-1200	Stabilizer	8E1080	8P1080	671,-
	In-line configuration	200-599 600-1200	Stabilizer Cross bar	8E1082	8P1082	
	On bath tub - only with door in recess	200-1200	Stabilizer	8E1081	8P1081	

Adjustment range = dimensions - 8mm / + 7mm

Slopes and cut-outs

Slopes and cut-outs	Extra charges
 Supplement per slope/cut-out for made-to-measure	170,-

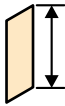
Dim. Range: min. - max.

	
500-2000	200-1200

Special options

Optional variants	Extra charges
Towel rail (high-gloss silver as standard, towel rail in black for Black Edition systems)	T99 210,-

Colours - Panel options

Profile colours	Colour code	Extra charges	Panel options	without Anti-Plaque		with Anti-Plaque	
				Glass code	Extra charges	Glass code	Extra charges
White	055	0,-	Clear	321	0,-	322	209,-
Matt silver	087		Grey	301		368	
Silver high-gloss	092	114,-	Bronze	341		378	
Black	023	156,-	Sand Plus	315	186,-	316	395,-
Grey/brown	061		Privatima	373		375	
			Bubbles	376		377	
			Mirror glass	380	439,-	381	648,-

HÜPPE Design pure		
Profile colours	Colour code	Extra charges
Black Edition	123	171,-

HÜPPE Design elegance Rectangular

HÜPPE Design pure Rectangular

elegance



pure

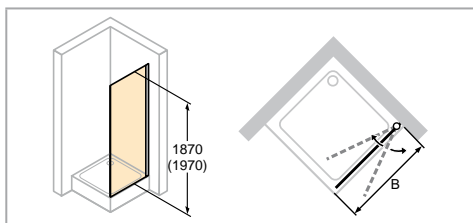

- Side panel can be combined with swing door, swing door with fixed segment and swing folding door.
- Towel rail height can be selected individually and must be specified with the order. If nothing is specified, the towel rail is always delivered middle of glass (height and width).

elegance

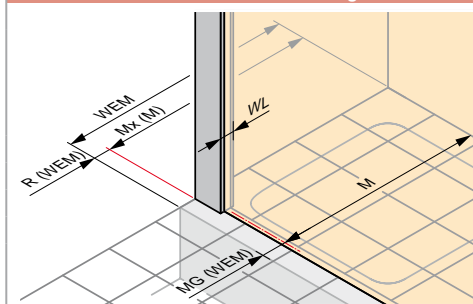

Dimensions

WL: 28
R: 15
Mx: M+15
MG: 30

WEM = Tray installation dim. (000)
M = installation dimension Centre glass (001)
Please always specify when ordering.

pure

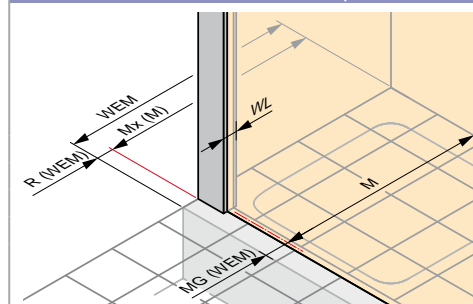

Dimensions

WL: 30
R: 15
Mx: M+15
MG: 30

WEM = Tray installation dim. (000)
M = installation dimension Centre glass (001)
Please always specify when ordering.

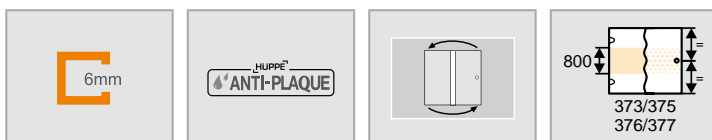

Movable side panel swing door

Height	Model	WEM B	M (middle of glass) B	elegance	pure	Base price
1900	SW 700	685-700	655-670	8E7701	8P7701	595,-
	SW 750	735-750	705-720	8E7702	8P7702	
	SW 800	785-800	755-770	8E7703	8P7703	
	SW 900	885-900	855-870	8E7704	8P7704	
	SW 1000	985-1000	955-970	8E7705	8P7705	
2000	SW 700	685-700	655-670	8E7706	8P7706	654,-
	SW 750	735-750	705-720	8E7707	8P7707	
	SW 800	785-800	755-770	8E7708	8P7708	
	SW 900	885-900	855-870	8E7709	8P7709	
	SW 1000	985-1000	955-970	8E7710	8P7710	

Made-to-measure

Height	Model	Width B	elegance	pure	Base price
to 2000	Standard made-to-measure	200-1100	8E7780	8P7780	772,-

Adjustment range = dimensions - 8mm / + 7mm

Slopes and cut-outs

Slopes and cut-outs	Extra charges
 Supplement per slope/cut-out for made-to-measure	170,-

Dim. Range: min. - max.

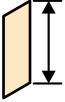
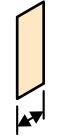
	
to 2000	200-1100

Special options

Optional variants	Extra charges
Towel rail (high-gloss silver as standard, towel rail in black for Black Edition systems)	T99 210,-

Colours - Panel options

Profile colours	Colour code	Extra charges	Panel options	without Anti-Plaque		with Anti-Plaque	
				Glass code	Extra charges	Glass code	Extra charges
White	055	0,-	Clear	321	0,-	322	209,-
Matt silver	087		Grey	301		368	
Black	023	156,-	Bronze	341		378	
Grey/brown	061		Sand Plus	315	186,-	316	395,-
Silver high-gloss	092		Privatima	373		375	
			Bubbles	376		377	
			Mirror glass	380	439,-	381	648,-

HÜPPE Design pure		
Profile colours	Colour code	Extra charges
Black Edition	123	171,-

HÜPPE Design elegance Rectangular

HÜPPE Design pure Rectangular

elegance



pure

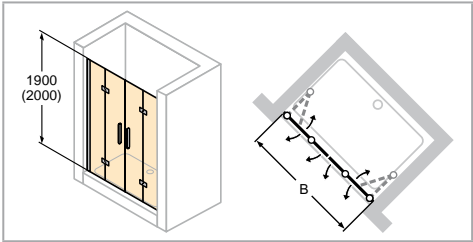

- Mirror glass (380/381): Please state in your order which segment should be produced with mirror glass. If this is not stated, the entire unit will be produced with mirror glass.
- For technical information, see Profile Colours and Panel Options section.

elegance

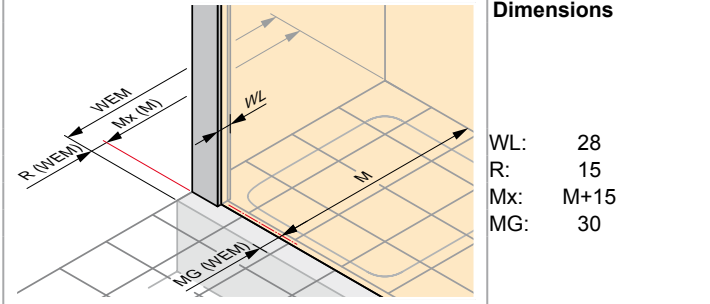

WEM = Tray installation dim. (000)
M = installation dimension Centre glass (001)
Please always specify when ordering.

pure

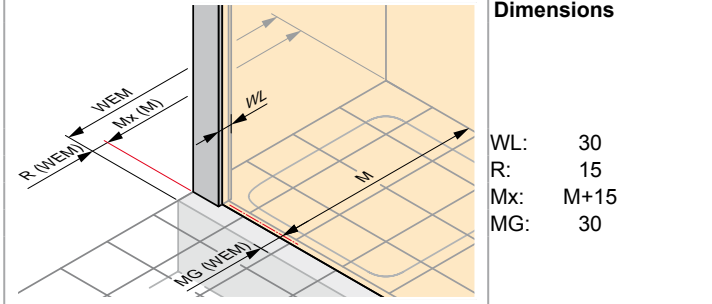

WEM = Tray installation dim. (000)
M = installation dimension Centre glass (001)
Please always specify when ordering.



6mm



HÜPPE[®]
ANTI-PLAQUE





800
373/375
376/377

Two folding swing doors in recess

Height	Model	WEM B	M (middle of glass) B	Entry width	elegance	pure	Base price
1900	1200	1180-1205	1180-1205	1040	8E7901	8P7901	1.485,-
	1400	1380-1405	1380-1405	1240	8E7902	8P7902	1.529,-
	1600	1580-1605	1580-1605	1440	8E7903	8P7903	1.606,-
	1800	1780-1805	1780-1805	1640	8E7904	8P7904	1.686,-
	2000	1980-2005	1980-2005	1740	8E7905	8P7905	1.771,-
2000	1200	1180-1205	1180-1205	1040	8E7906	8P7906	1.632,-
	1400	1380-1405	1380-1405	1240	8E7907	8P7907	1.681,-
	1600	1580-1605	1580-1605	1440	8E7908	8P7908	1.766,-
	1800	1780-1805	1780-1805	1640	8E7909	8P7909	1.854,-
	2000	1980-2005	1980-2005	1740	8E7910	8P7910	1.948,-

Made-to-measure

Height	Width B	elegance	pure	Base price
1400-2000	1000-1200	8E7981	8P7981	1.781,-
	1201-1600	8E7982	8P7982	1.928,-
	1601-2000	8E7983	8P7983	2.125,-

Adjustment range = dimensions - 13mm / + 12mm

Dim. Range: min. - max.

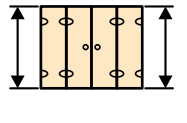
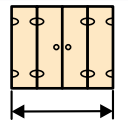
	
1400-2000	1000-2000

Extras

Height	Profile	elegance	pure	Price
1900		8E2501	8P2501	32,-
2000		8E2502	8P2502	

Colours - Panel options

Profile colours	Colour code	Extra charges	Panel options	without Anti-Plaque		with Anti-Plaque	
				Glass code	Extra charges	Glass code	Extra charges
White	055	0,-	Clear	321	0,-	322	418,-
Matt silver	087		Grey	301		368	
Black	023	312,-	Bronze	341		378	
Grey/brown	061		Sand Plus	315	371,-	316	789,-
Silver high-gloss	092		Privatima	373		375	
			Bubbles	376		377	
			Mirror glass	380	439,-	381	857,-

HÜPPE Design pure		
Profile colours	Colour code	Extra charges
Black Edition	123	342,-

HÜPPE Design elegance Rectangular

HÜPPE Design pure Rectangular

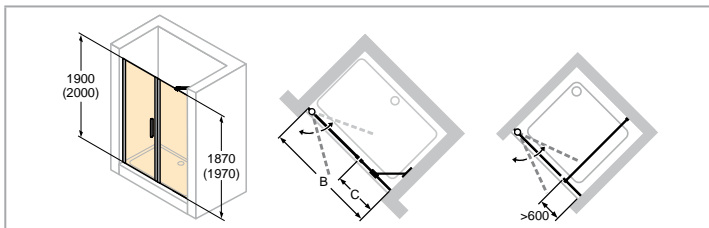
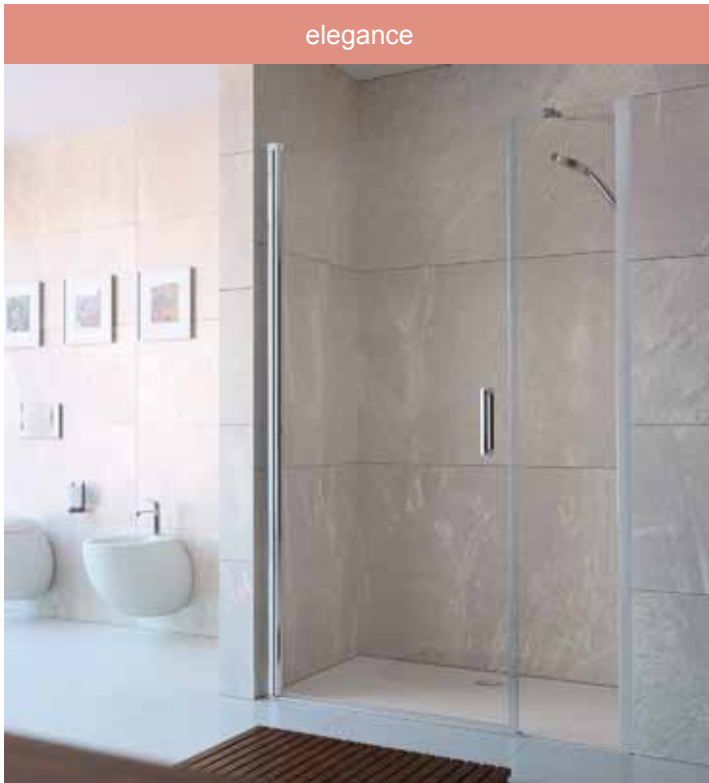

- Mirror glass (380/381): Please state in your order which segment should be produced with mirror glass. If this is not stated, the entire unit will be produced with mirror glass.
- For technical information, see Profile Colours and Panel Options section.

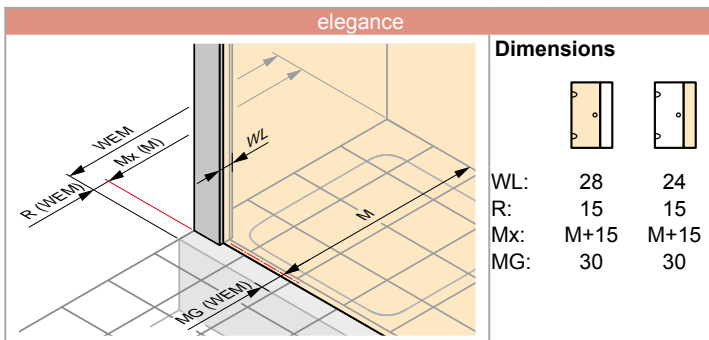

WEM = Tray installation dim. (000)
M = installation dimension Centre glass (001)
Please always specify when ordering.

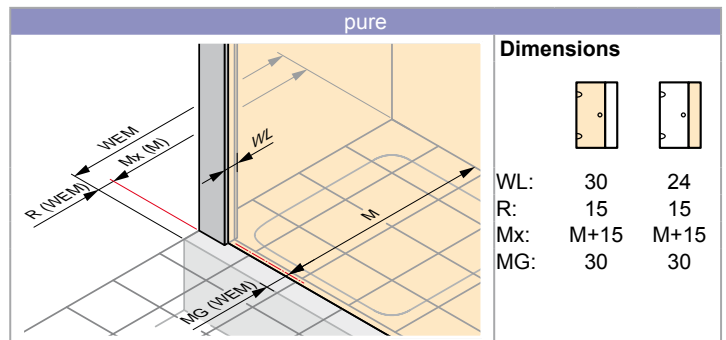

WEM = Tray installation dim. (000)
M = installation dimension Centre glass (001)
Please always specify when ordering.

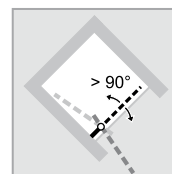
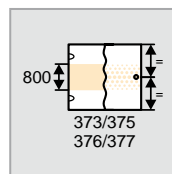
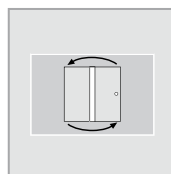
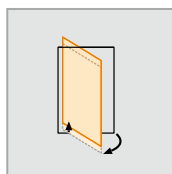
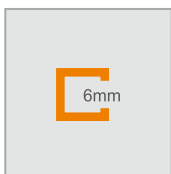

Swing door with additional section in recess

Height	Model	WEM B	M (middle of glass) B	Additional section width	Entry width	elegance	pure	Base price
1900	900	885-915	885-915	235-250	580	8E7201	8P7201	1.056,-
	1000	985-1015	985-1015	235-250	680	8E7202	8P7202	1.097,-
	1100	1085-1115	1085-1115	335-350	680	8E7203	8P7203	
	1200	1185-1215	1185-1215	435-450	680	8E7204	8P7204	1.119,-
	1400	1385-1415	1385-1415	535-550	780	8E7205	8P7205	
2000	900	885-915	885-915	235-250	580	8E7206	8P7206	1.160,-
	1000	985-1015	985-1015	235-250	680	8E7207	8P7207	1.206,-
	1100	1085-1115	1085-1115	335-350	680	8E7208	8P7208	
	1200	1185-1215	1185-1215	435-450	680	8E7209	8P7209	1.231,-
	1400	1385-1415	1385-1415	535-550	780	8E7210	8P7210	

Made-to-measure





Height	Width B	elegance	pure	Base price
1400-2000	700-1200	8E7280	8P7280	1.371,-
	1201-1600	8E7281	8P7281	1.765,-
	1601-2300	8E7282	8P7282	2.158,-

Adjustment range = dimensions - 15mm / + 15mm

Slopes and cut-outs

Slopes and cut-outs	Extra charges
	Supplement per slope/cut-out for made-to-measure 170,-

Dim. Range: min. - max.

			
1400-2000	700-2300	max. 1100	190-1200

Extras

Height	Profile	elegance	pure	Price
1900	Extension profile, 15mm	8E2501	8P2501	32,-
	Additional section	8E4201	8P4201	
2000	Extension profile, 15mm	8E2502	8P2502	
	Additional section	8E4202	8P4202	

Colours - Panel options

Profile colours	Colour code	Extra charges	Panel options	without Anti-Plaque		with Anti-Plaque	
				Glass code	Extra charges	Glass code	Extra charges
White	055	0,-	Clear	321	0,-	322	209,-
Matt silver	087		Grey	301		368	
Black	023	156,-	Bronze	341		378	
Grey/brown	061		Sand Plus	315	186,-	316	395,-
Silver high-gloss	092		Privatima	373		375	
			Bubbles	376		377	
			Mirror glass	380	439,-	381	648,-

HÜPPE Design pure

Profile colours	Colour code	Extra charges
Black Edition	123	171,-

HÜPPE Design pure Rectangular

pure

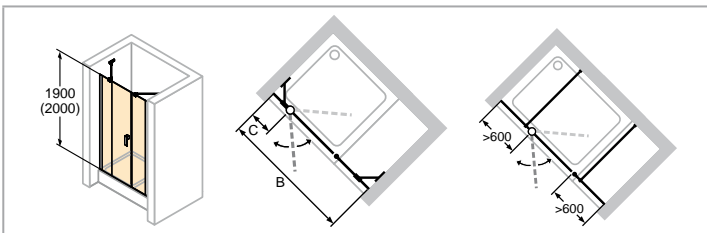

Glass 373/375 Privatima: Specification in the order whether left-hand or right-hand fixing.

- Mirror glass (380/381): Please state in your order which segment should be produced with mirror glass. If this is not stated, the entire unit will be produced with mirror glass.
- For technical information, see Profile Colours and Panel Options section.

Dimensions	
WL:	24
R:	15
Mx:	M+15
MG:	30

WEM = Tray installation dim. (000)
M = installation dimension Centre glass (001)
Please always specify when ordering.

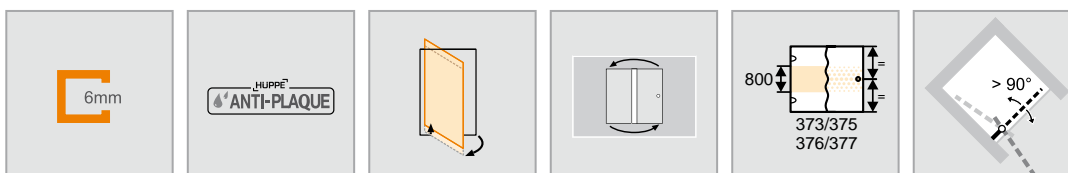

Swing door with fixed segment and additional section in recess

Height	Model	WEM B	M (middle of glass) B	Width of fixed segment C	Additional section width	Entry width	pure	Base price
1900	1000	985-1015	985-1015	260-275	235-250	480	8P7301	1.318,-
	1100	1085-1115	1085-1115	260-275	235-250	580	8P7302	
	1200	1185-1215	1185-1215	260-275	235-250	680	8P7303	
	1400	1385-1415	1385-1415	360-375	335-350	680	8P7304	
	1600	1585-1615	1585-1615	415-430	385-400	780	8P7305	
2000	1000	985-1015	985-1015	260-275	235-250	480	8P7306	1.451,-
	1100	1085-1115	1085-1115	260-275	235-250	580	8P7307	
	1200	1185-1215	1185-1215	260-275	235-250	680	8P7308	
	1400	1385-1415	1385-1415	360-375	335-350	680	8P7309	
	1600	1585-1615	1585-1615	415-430	385-400	780	8P7310	

Made-to-measure





Height	Width B	Width of fixed segment	pure	Base price
1400-2000	900-1200	230-650	8P7380	1.715,-
	1201-1600	230-650	8P7381	2.108,-
	1601-2700	230-650	8P7382	2.502,-

Adjustment range = dimensions - 15mm / + 15mm

Slopes and cut-outs

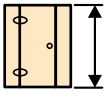
Slopes and cut-outs	Extra charges
	Supplement per slope/cut-out for made-to-measure 170,-

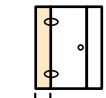
Dim. Range: min. - max.

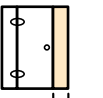
				
1400-2000	900-2700	230-650	max. 900	190-1200

Extras

Height	Profile	pure	Price
1900		8P4201	32,-
2000		8P4202	

Colours - Panel options

Profile colours	Colour code	Extra charges	Panel options	
			without Anti-Plaque Glass code	with Anti-Plaque Glass code
White	055	0,-	321	322
Matt silver	087		301	368
Black	023		341	378
Grey/brown	061	312,-	315	316
Silver high-gloss	092		373	375
Black Edition	123	342,-	376	377
			380	381

HÜPPE Design elegance Rectangular

HÜPPE Design pure Rectangular

elegance



pure

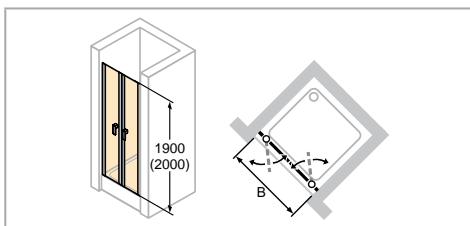

- Mirror glass (380/381): Please state in your order which segment should be produced with mirror glass. If this is not stated, the entire unit will be produced with mirror glass.
- For technical information, see Profile Colours and Panel Options section.

elegance

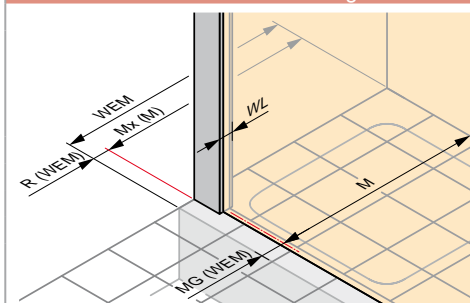

Dimensions

WL:	28
R:	15
Mx:	M+15
MG:	30

WEM = Tray installation dim. (000)
 M = installation dimension Centre glass (001)
 Please always specify when ordering.

pure

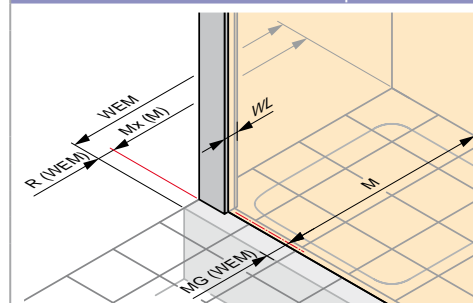

Dimensions

WL:	30
R:	15
Mx:	M+15
MG:	30

WEM = Tray installation dim. (000)
 M = installation dimension Centre glass (001)
 Please always specify when ordering.

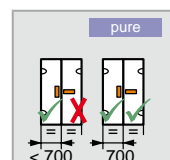
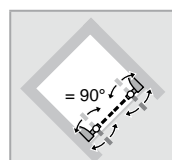
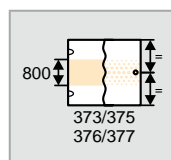
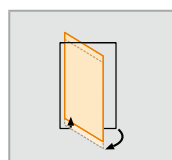
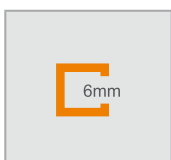

Two-way door in recess

Height	Model	WEM B	M (middle of glass) B	Entry width	elegance	pure	Base price
1900	780	760-785	760-785	620	8E1307	8P1307	848,-
	800	780-805	780-805	640	8E1301	8P1301	
	880	860-885	860-885	720	8E1308	8P1308	
	900	880-905	880-905	740	8E1302	8P1302	882,-
	980	960-985	960-985	820	8E1309	8P1309	
	1000	980-1005	980-1005	840	8E1303	8P1303	
2000	780	760-785	760-785	620	8E1310	8P1310	933,-
	800	780-805	780-805	640	8E1304	8P1304	
	880	860-885	860-885	720	8E1311	8P1311	
	900	880-905	880-905	740	8E1305	8P1305	971,-
	980	960-985	960-985	820	8E1312	8P1312	
	1000	980-1005	980-1005	840	8E1306	8P1306	

Made-to-measure

Height	Model	Width B	elegance	pure	Base price
1400-2000	Standard made-to-measure	500-1800	8E1380	8P1380	1.101,-

Adjustment range = dimensions - 13mm / + 12mm

Dim. Range: min. - max.

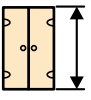
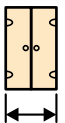
	
1400-2000	500-1800

Extras

Height	Profile	elegance	pure	Price
1900	Extension profile, 15mm	8E2501	8P2501	32,-
2000	Extension profile, 15mm	8E2502	8P2502	

Colours - Panel options

Profile colours	Colour code	Extra charges
White	055	0,-
Matt silver	087	
Black	023	156,-
Grey/brown	061	
Silver high-gloss	092	

HÜPPE Design pure

Profile colours	Colour code	Extra charges
Black Edition	123	171,-

Panel options	without Anti-Plaque		with Anti-Plaque	
	Glass code	Extra charges	Glass code	Extra charges
Clear	321	0,-	322	209,-
Grey	301	186,-	368	395,-
Bronze	341		378	
Sand Plus	315		316	
Privatima	373	439,-	375	648,-
Bubbles	376		377	
Mirror glass	380		381	

HÜPPE Design elegance Rectangular

HÜPPE Design pure Rectangular

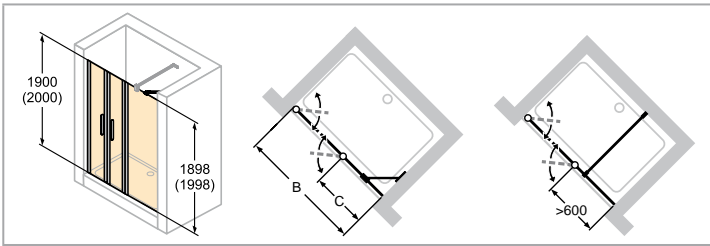

- Mirror glass (380/381): Please state in your order which segment should be produced with mirror glass. If this is not stated, the entire unit will be produced with mirror glass.
- For technical information, see Profile Colours and Panel Options section.

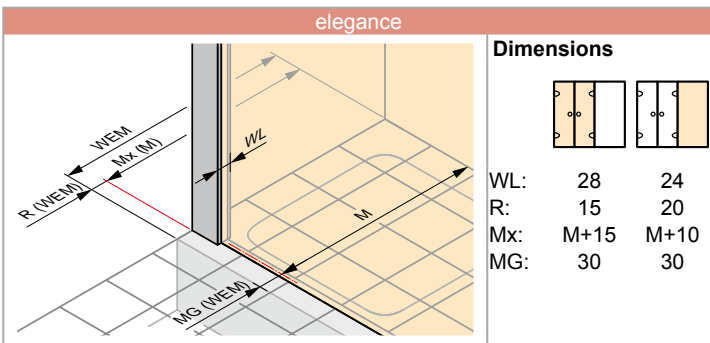

WEM = Tray installation dim. (000)
M = installation dimension Centre glass (001)
Please always specify when ordering.

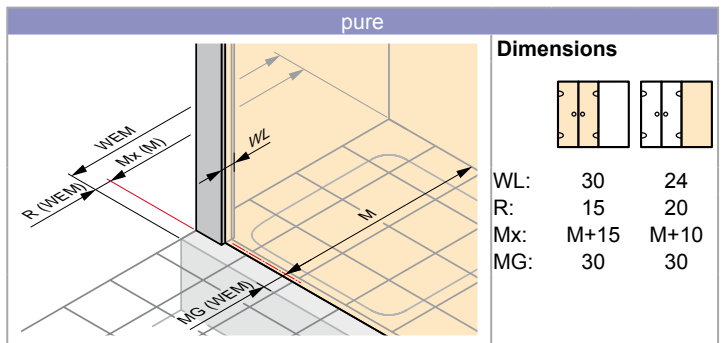

WEM = Tray installation dim. (000)
M = installation dimension Centre glass (001)
Please always specify when ordering.

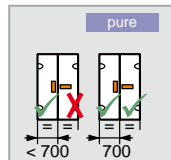
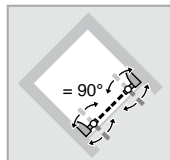
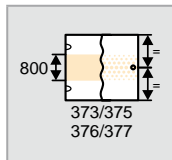
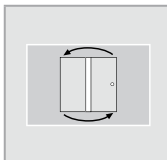
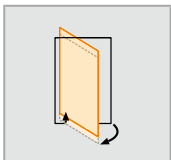
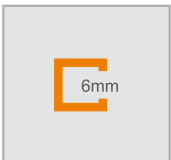

Two-way door with fixed segment in recess

Height	Model	WEM B	M (middle of glass) B	Width panel C	Entry width	elegance	pure	Base price
1900	1200	1180-1205	1180-1205	392-407	750	8E7501	8P7501	1.188,-
	1400	1380-1405	1380-1405	392-407	950	8E7502	8P7502	1.225,-
	1600	1580-1605	1580-1605	592-607	950	8E7503	8P7503	1.235,-
	1800	1780-1805	1780-1805	792-807	950	8E7504	8P7504	1.482,-
2000	1200	1180-1205	1180-1205	392-407	750	8E7505	8P7505	1.305,-
	1400	1380-1405	1380-1405	392-407	950	8E7506	8P7506	1.345,-
	1600	1580-1605	1580-1605	592-607	950	8E7507	8P7507	1.357,-
	1800	1780-1805	1780-1805	792-807	950	8E7508	8P7508	1.630,-

Made-to-measure





Height	Width B	elegance	pure	Base price
1400-2000	1000-1600	8E7581	8P7581	1.482,-
	1601-2000	8E7582	8P7582	1.777,-

Adjustment range = dimensions - 13mm / + 12mm

Slopes and cut-outs

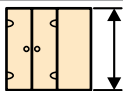
Slopes and cut-outs	Extra charges
	Supplement per slope/cut-out for made-to-measure 170,-

Dim. Range: min. - max.

			
1400-2000	1000-2000	770-1350	230-650

Extras

Height	Profile	elegance	pure	Price
1900		8E2501	8P2501	32,-
2000		8E2502	8P2502	

Colours - Panel options

Profile colours	Colour code	Extra charges	Panel options	without Anti-Plaque		with Anti-Plaque	
				Glass code	Extra charges	Glass code	Extra charges
White	055	0,-	Clear	321	0,-	322	209,-
Matt silver	087		Grey	301		368	
Black	023		Bronze	341		378	
Grey/brown	061		Sand Plus	315	186,-	316	395,-
Silver high-gloss	092		Privatima	373		375	
HÜPPE Design pure			Bubbles	376		377	
Profile colours			Mirror glass	380	439,-	381	648,-
Black Edition		123					171,-

HÜPPE Design elegance Rectangular

HÜPPE Design pure Rectangular

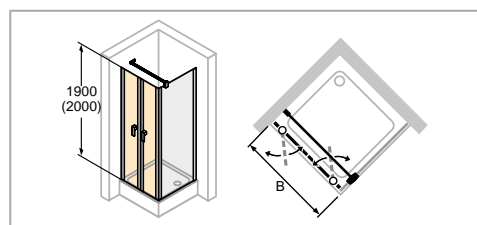

- Mirror glass (380/381): Please state in your order which segment should be produced with mirror glass. If this is not stated, the entire unit will be produced with mirror glass.
- For technical information, see Profile Colours and Panel Options section.

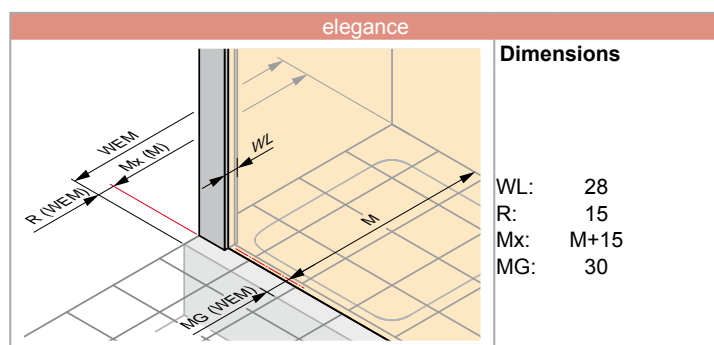

WEM = Tray installation dim. (000)
M = installation dimension Centre glass (001)
Please always specify when ordering.

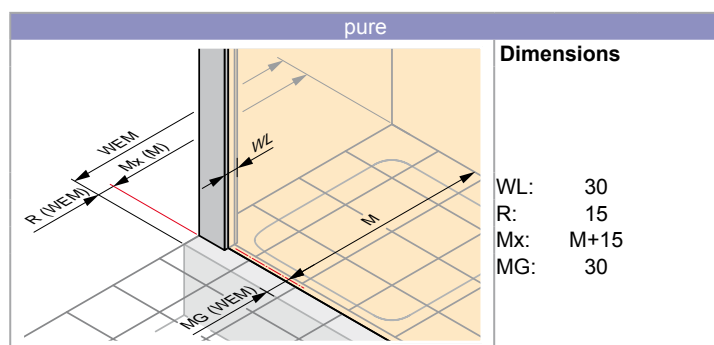

WEM = Tray installation dim. (000)
M = installation dimension Centre glass (001)
Please always specify when ordering.

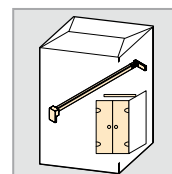
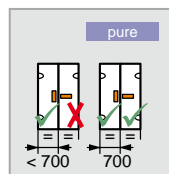
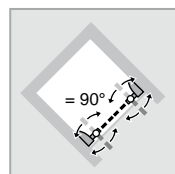
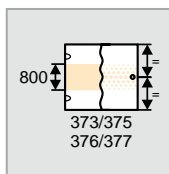
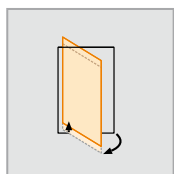
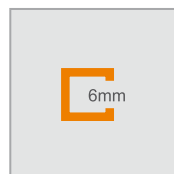

Two-way door for side panel

Installation on shower tray recommended

Height	Model	WEM B	M (middle of glass) B	Entry width	elegance	pure	Base price
1900	800	775-805	745-775	600	8E1401	8P1401	848,-
	900	875-905	845-875	700	8E1402	8P1402	
	1000	975-1005	945-975	800	8E1403	8P1403	882,-
2000	800	775-805	745-775	600	8E1404	8P1404	933,-
	900	875-905	845-875	700	8E1405	8P1405	
	1000	975-1005	945-975	800	8E1406	8P1406	971,-

Floor-flush installation recommended



Height	Model	M (middle of glass) B	elegance	pure	Base price
2000	800	785-815	8E1407	8P1407	933,-
	900	885-915	8E1408	8P1408	
	1000	985-1015	8E1409	8P1409	971,-

Made-to-measure

Height	Model	Width B	elegance	pure	Base price
1400-2000	Standard made-to-measure	500-1600	8E1480	8P1480	1.101,-

Adjustment range = dimensions - 15mm / + 15mm

Dim. Range: min. - max.

	
1400-2000	500-1600

Extras

Height	Profile	elegance	pure	Price
1900	Extension profile, 15mm	8E2501	8P2501	32,-
2000	Extension profile, 15mm	8E2502	8P2502	

Colours - Panel options

Profile colours	Colour code	Extra charges
White	055	0,-
Matt silver	087	
Black	023	156,-
Grey/brown	061	
Silver high-gloss	092	

HÜPPE Design pure

Profile colours	Colour code	Extra charges
Black Edition	123	171,-

Panel options	without Anti-Plaque		with Anti-Plaque	
	Glass code	Extra charges	Glass code	Extra charges
Clear	321	0,-	322	209,-
Grey	301	186,-	368	395,-
Bronze	341		378	
Sand Plus	315		316	
Privatima	373	439,-	375	648,-
Bubbles	376		377	
Mirror glass	380		381	

HÜPPE Design elegance Rectangular

HÜPPE Design pure Rectangular

elegance



pure

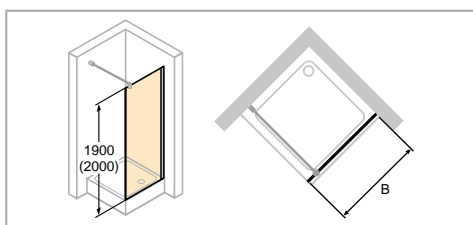

- Shortened side panel can only be combined with door in recess.
- Cannot be ordered as a free-standing side panel.
- Towel rail height can be selected individually and must be specified with the order. If nothing is specified, the towel rail is always delivered middle of glass (height and width).

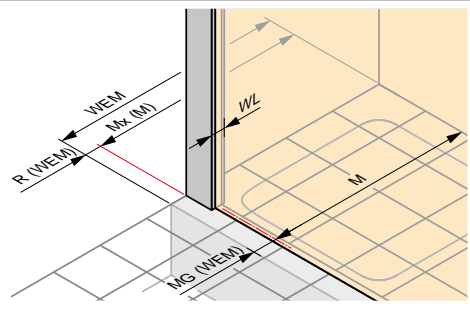

Dimensions

WL: 24
R: 20
Mx: M+10
MG: 30

WEM = Tray installation dim. (000)
M = installation dimension Centre glass (001)
Please always specify when ordering.

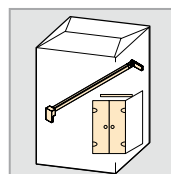
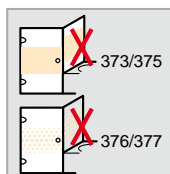
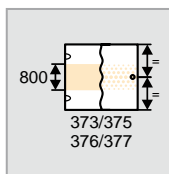
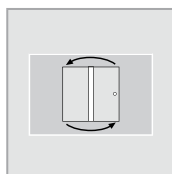
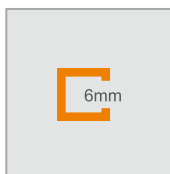

Side panel for two-way door

Installation on shower tray recommended

Height	Model	WEM B	M (middle of glass) B	elegance	pure	Base price
1900	SW 700	685-700	655-670	8E1501	8P1501	517,-
	SW 750	735-750	705-720	8E1502	8P1502	
	SW 800	785-800	755-770	8E1503	8P1503	
	SW 900	885-900	855-870	8E1504	8P1504	
	SW 1000	985-1000	955-970	8E1505	8P1505	538,-
2000	SW 700	685-700	655-670	8E1510	8P1510	569,-
	SW 750	735-750	705-720	8E1511	8P1511	
	SW 800	785-800	755-770	8E1512	8P1512	
	SW 900	885-900	855-870	8E1513	8P1513	
	SW 1000	985-1000	955-970	8E1514	8P1514	591,-
1650	SWK 700	685-700	650-665	8E1506	8P1506	517,-
	SWK 750	735-750	700-715	8E1507	8P1507	
	SWK 800	785-800	750-765	8E1508	8P1508	
	SWK 900	885-900	850-865	8E1509	8P1509	
1750	SWK 700	685-700	650-665	8E1515	8P1515	517,-
	SWK 750	735-750	700-715	8E1516	8P1516	
	SWK 800	785-800	750-765	8E1517	8P1517	
	SWK 900	885-900	850-865	8E1518	8P1518	

Floor-flush installation recommended

Height	Model	M (middle of glass) B	elegance	pure	Base price
2000	SW 700	692-707	8E1519	8P1519	569,-
	SW 750	742-757	8E1520	8P1520	
	SW 800	792-807	8E1521	8P1521	
	SW 900	892-907	8E1522	8P1522	
	SW 1000	992-1007	8E1523	8P1523	591,-

Made-to-measure

Height	Model	Width B	elegance	pure	Base price
500-2000	Standard made-to-measure	200-1200	8E1580	8P1580	671,-
	On bath tub - only with two way door in recess (PTN)	200-1200	8E1581	8P1581	

Adjustment range = dimensions - 8mm / + 7mm

Slopes and cut-outs

Slopes and cut-outs	Extra charges
	Supplement per slope/cut-out for made-to-measure
	170,-

Dim. Range: min. - max.

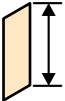
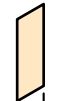
	
500-2000	200-1200

Special options

Optional variants	Extra charges
Towel rail (high-gloss silver as standard, towel rail in black for Black Edition systems)	T99 210,-

Colours - Panel options

Profile colours	Colour code	Extra charges	Panel options	without Anti-Plaque		with Anti-Plaque	
				Glass code	Extra charges	Glass code	Extra charges
White	055	0,-	Clear	321	0,-	322	209,-
Matt silver	087		Grey	301		368	
Silver high-gloss	092	114,-	Bronze	341		378	
Black	023	156,-	Sand Plus	315	186,-	316	395,-
Grey/brown	061		Privatima	373		375	
			Bubbles	376		377	
			Mirror glass	380	439,-	381	648,-

HÜPPE Design pure		
Profile colours	Colour code	Extra charges
Black Edition	123	171,-

HÜPPE Design elegance Quadrant

HÜPPE Design pure Quadrant

elegance



pure

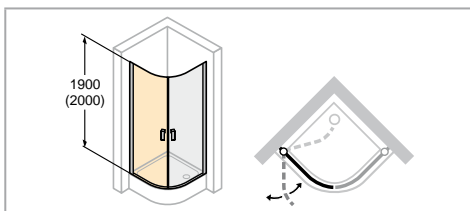

▪ No made-to-measure possible.

elegance

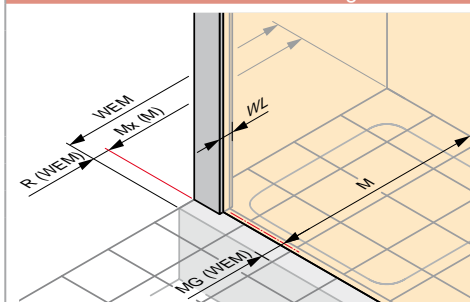

Dimensions

WL: 28
R: 15
Mx: M+15
MG: 30

WEM = Tray installation dim. (000)
M = installation dimension Centre glass (001)
Please always specify when ordering.

pure

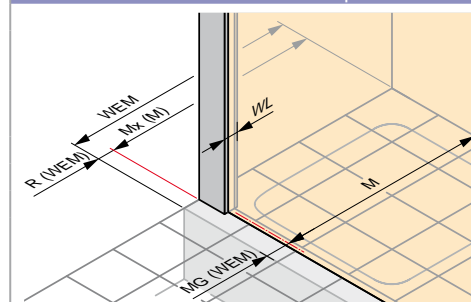

Dimensions

WL: 30
R: 15
Mx: M+15
MG: 30

WEM = Tray installation dim. (000)
M = installation dimension Centre glass (001)
Please always specify when ordering.

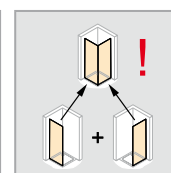
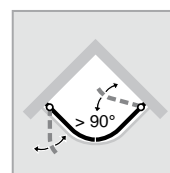
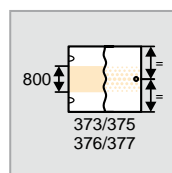
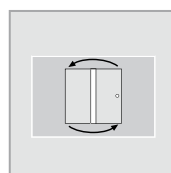
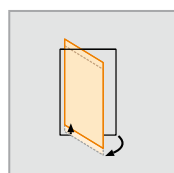
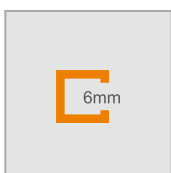

Swing door 2-panel

Height	Model	WEM B	M (middle of glass) B	Entry width	Radius	elegance	pure	Base price	
1900	800	785-800	755-770	961	500	8E1601	8P1601	760,-	
	900	885-900	855-870	1103	500	8E1602	8P1602		
	1000	985-1000	955-970	1245	500	8E1603	8P1603		
	1900	800	785-800	755-770	961	550	8E1604	8P1604	760,-
		900	885-900	855-870	1103	550	8E1605	8P1605	
		1000	985-1000	955-970	1245	550	8E1606	8P1606	
2000	800	785-800	755-770	961	500	8E1607	8P1607	836,-	
	900	885-900	855-870	1103	500	8E1608	8P1608		
	1000	985-1000	955-970	1245	500	8E1609	8P1609		
	2000	800	785-800	755-770	961	550	8E1610	8P1610	836,-
		900	885-900	855-870	1103	550	8E1611	8P1611	
		1000	985-1000	955-970	1245	550	8E1612	8P1612	

NOTE: Price, item no. per panel.

Dim. Range: min. - max.

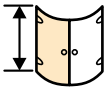
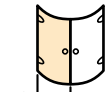
	
1900/2000	800/900/1000

Extras

Height	Profile	elegance	pure	Price
1900		8E2501	8P2501	32,-
2000		8E2502	8P2502	

Colours - Panel options

Profile colours	Colour code	Extra charges	Panel options		without Anti-Plaque		with Anti-Plaque	
			Glass code	Extra charges	Glass code	Extra charges		
White	055	0,-	Clear	321	0,-	322	209,-	
Matt silver	087		Sand Plus	315		316		
Black	023		Privatima	373	186,-	375	395,-	
Grey/brown	061		Bubbles	376		377		
Silver high-gloss	092							

HÜPPE Design pure

Profile colours	Colour code	Extra charges
Black Edition	123	171,-

HÜPPE Design elegance Quadrant

HÜPPE Design pure Quadrant

elegance



pure

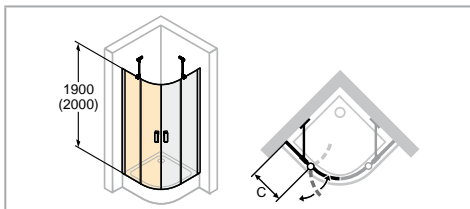

Glass 373/375 Privatima: Specification in the order whether left-hand or right-hand fixing.

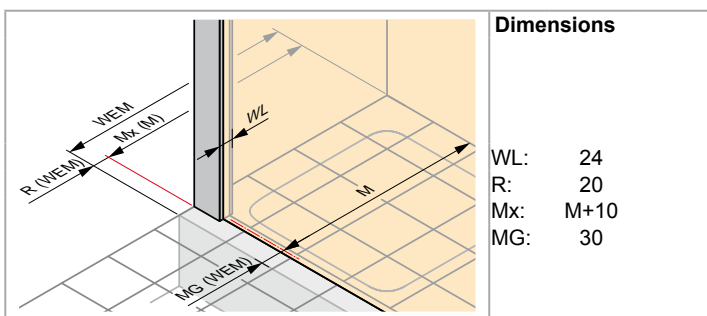

WEM = Tray installation dim. (000)
M = installation dimension Centre glass (001)
Please always specify when ordering.

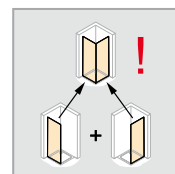
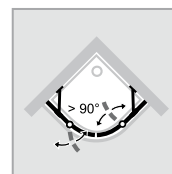
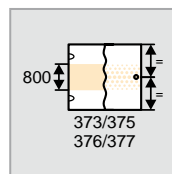
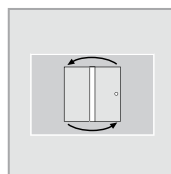
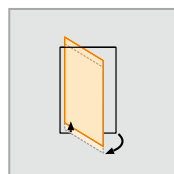
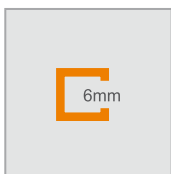

Swing door with fixed segments, 2-panel

Installation on shower tray recommended

Height	Model	WEM	M (middle of glass)	Entry width	C	Radius	elegance	pure	Base price	
1900	800	785-800	755-770	630	280-295	500	8E1701	8P1701	760,-	
	900	885-900	855-870	630	380-395	500	8E1702	8P1702		
	1000	985-1000	955-970	630	480-495	500	8E1703	8P1703		790,-
	2000	800	785-800	755-770	685	235-250	550	8E1704	8P1704	760,-
		900	885-900	855-870	685	335-350	550	8E1705	8P1705	
		1000	985-1000	955-970	685	435-450	550	8E1706	8P1706	790,-
800		785-800	755-770	630	280-295	500	8E1707	8P1707	836,-	
900	885-900	855-870	630	380-395	500	8E1708	8P1708			
1000	985-1000	955-970	630	480-495	500	8E1709	8P1709	868,-		
800	785-800	755-770	685	235-250	550	8E1710	8P1710	836,-		
900	885-900	855-870	685	335-350	550	8E1711	8P1711			
1000	985-1000	955-970	685	435-450	550	8E1712	8P1712	868,-		

NOTE: Price, item no. per panel.

Floor-flush installation recommended

Height	Model	M (middle of glass)	Radius	elegance	pure	Base price	
2000	800	792-807	500	8E1713	8P1713	836,-	
	900	892-907	500	8E1714	8P1714		
	1000	992-1007	500	8E1715	8P1715		868,-
	2000	800	792-807	550	8E1716	8P1716	836,-
		900	892-907	550	8E1717	8P1717	
		1000	992-1007	550	8E1718	8P1718	868,-

Made-to-measure

Height	Width	C	Radius	elegance	pure	Base price
1900/2000	735-1135	200-600	500	8E1780	8P1780	986,-
	735-1135	200-600	550	8E1781	8P1781	

Made-to-measure available for width only

Adjustment range = dimensions - 8mm / + 7mm

Slopes and cut-outs

Slopes and cut-outs	Extra charges
	Supplement per slope/cut-out for made-to-measure 170,-

Dim. Range: min. - max.

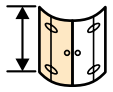
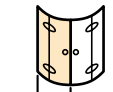
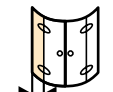
		
1900/2000	735-1135	200-600

Extras

Height	Profile	elegance	pure	Price
1900	Extension profile, 15mm 	8E4201	8P4201	32,-
2000		8E4202	8P4202	

Colours - Panel options

Profile colours	Colour code	Extra charges	Panel options		without Anti-Plaque		with Anti-Plaque	
			Glass code	Extra charges	Glass code	Extra charges		
White	055	0,-	Clear	321	0,-	322	209,-	
Matt silver	087		Sand Plus	315		316		
Black	023		Privatima	373	186,-	375	395,-	
Grey/brown	061		Bubbles	376		377		
Silver high-gloss	092							

HÜPPE Design pure

Profile colours	Colour code	Extra charges
Black Edition	123	171,-

HÜPPE Design elegance Pentagonal

elegance

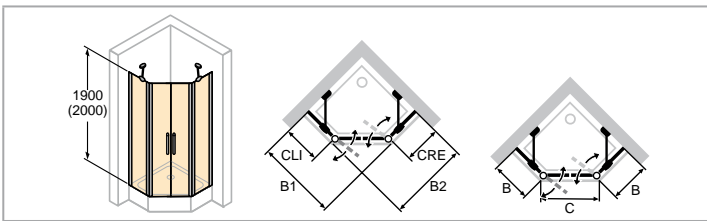

Dimensions	
WL:	24
R:	20
Mx:	M+10
MG:	30

WEM = Tray installation dim. (000)
M = installation dimension Centre glass (001)
Please always specify when ordering.

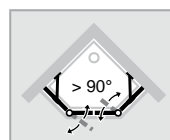
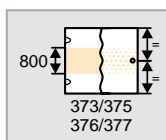
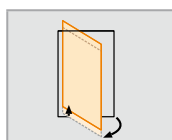
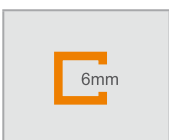

Swing door with fixed segments, 2-panel

Height	Model B1/B2	WEM B1/B2	M (middle of glass) B1/B2	CLI	CRE	B	C	Entry width	elegance	Base price
1900	900 x 900	885-900/ 885-900	855-870	449-464	449-464	475	600	543	8E1803	1.520,-
	900 x 900	885-900/ 885-900	855-870	424-439	424-439	450	636	578	8E1801	
	1000 x 1000	985-1000/ 985-1000	955-970	509-524	509-524	535	657	599	8E1804	1.581,-
	1000 x 1000	985-1000/ 985-1000	955-970	474-489	474-489	500	707	649	8E1802	
2000	900 x 900	885-900/ 885-900	855-870	449-464	449-464	475	600	543	8E1807	1.671,-
	900 x 900	885-900/ 885-900	855-870	424-439	424-439	450	636	578	8E1805	
	1000 x 1000	985-1000/ 985-1000	955-970	509-524	509-524	535	657	599	8E1808	1.739,-
	1000 x 1000	985-1000/ 985-1000	955-970	474-489	474-489	500	707	649	8E1806	

Made-to-measure



Height	Model	Width	CLI	CRE	Entry width	elegance	Base price
1400-2000	Shower tray	785-1090	200-600	200-600	543	8E1881	1.975,-
	Shower tray	785-1090	200-600	200-600	578	8E1880	
	Shower tray	785-1090	200-600	200-600	599	8E1883	
	Shower tray	785-1090	200-600	200-600	649	8E1882	
	Floor-flush	785-1090	200-600	200-600	543-649	8E1890	

Adjustment range = dimensions - 8mm / + 7mm

Slopes and cut-outs

Slopes and cut-outs	Extra charges
	Supplement per slope/cut-out for made-to-measure 170,-

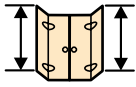
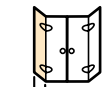
Dim. Range: min. - max.

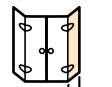
				
1400-2000	200-600	785-1090	785-1090	200-600

Extras

Height	Profile	elegance	Price
1900		8E4201	32,-
2000		8E4202	

Colours - Panel options

Profile colours	Colour code	Extra charges	Panel options	without Anti-Plaque		with Anti-Plaque	
				Glass code	Extra charges	Glass code	Extra charges
White	055	0,-	Clear	321	0,-	322	418,-
Matt silver	087		Grey	301	371,-	368	789,-
Black	023		Bronze	341		378	
Grey/brown	061		Sand Plus	315		316	
Silver high-gloss	092		Privatima	373		375	
			Bubbles	376		377	



HÜPPE Design elegance U-shaped enclosure

HÜPPE Design pure U-shaped enclosure

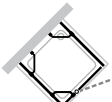
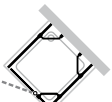
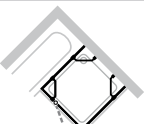
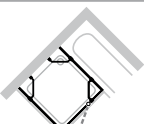
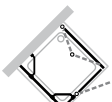

HÜPPE Design elegance Rectangular HÜPPE Design pure Rectangular

Swing door, rectangular U-shaped enclosure

Height	Width	Consisting of:	For ...	elegance	pure	Price
1400-2000 1400-2000	700-1200 200-1200	1 swing door with fixed segment 2 side panels 1 extension kit for U-shaped enclosure		8E3380	8P3380	2.412,-
1400-2000 1400-2000	700-1200 200-1200	1 swing door with fixed segment 2 side panels 1 extension kit for U-shaped enclosure		8E4480	8P4480	2.412,-
1400-2000 1400-2000 1400-2000	700-1200 200-1200 200-1200	1 swing door with fixed segment 1 short side panel 1 side panel 1 extension kit for U-shaped enclosure		8E3180	8P3180	2.412,-
1400-2000 1400-2000 1400-2000	700-1200 200-1200 200-1200	1 swing door with fixed segment 1 short side panel 1 side panel 1 extension kit for U-shaped enclosure		8E3280	8P3280	2.412,-
1400-2000 1400-2000 1400-2000	500-1250 700-1200 200-1200	1 folding swing door - Right-hand fixing 1 swing door with fixed segment 1 side panel 1 extension kit for U-shaped enclosure		8E5280	8P5280	2.842,-
1400-2000 1400-2000 1400-2000	500-1250 700-1200 200-1200	1 folding swing door - Left-hand fixing 1 swing door with fixed segment 1 side panel 1 extension kit for U-shaped enclosure		8E5380	8P5380	2.842,-

It must be stated whether the specified dimensions refer to the tray installation dimensions or the middle glass installation dimensions (e.g. floor-flush).

The following therefore needs to be specified in the order with respect to dimensions:

Refers to the tray installation dimensions: 000

Refers to the middle glass installation dimensions: 001

Colours - Panel options

Profile colours	Colour code	Extra charges
White	055	0,-
Matt silver	087	
Black	023	312,-
Grey/brown	061	
Silver high-gloss	092	

Panel options	without Anti-Plaque		with Anti-Plaque	
	Glass code	Extra charges	Glass code	Extra charges
Clear	321	0,-	322	418,-
Grey	301	371,-	368	789,-
Bronze	341		378	
Sand Plus	315		316	

HÜPPE Design pure

Profile colours	Colour code	Extra charges
Black Edition	123	342,-

HÜPPE Design elegance Rectangular

HÜPPE Design pure Rectangular

Swing door, rectangular U-shaped enclosure

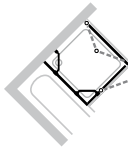
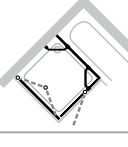
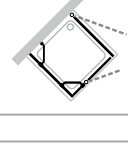
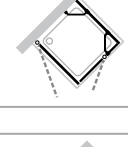
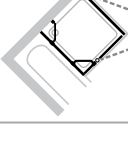
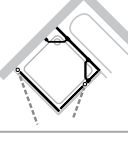
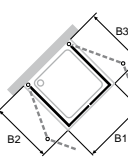
Height	Width	Consisting of:	For ...	elegance	pure	Price
1400-2000 1400-2000 1400-2000	500-1250 700-1200 200-1200	1 folding swing door - Right-hand fixing 1 swing door with fixed segment 1 short side panel 1 extension kit for U-shaped enclosure		8E5480	8P5480	2.842,-
1400-2000 1400-2000 1400-2000	500-1250 700-1200 200-1200	1 folding swing door - Left-hand fixing 1 swing door with fixed segment 1 short side panel 1 extension kit for U-shaped enclosure		8E5580	8P5580	2.842,-
1400-2000 1400-2000 1400-2000	700-1200 500-1100 200-1200	1 swing door with fixed segment 1 swing door 1 side panel 1 extension kit for U-shaped enclosure		8E5680	8P5680	2.699,-
1400-2000 1400-2000 1400-2000	700-1200 500-1100 200-1200	1 swing door with fixed segment 1 swing door 1 side panel 1 extension kit for U-shaped enclosure		8E5780	8P5780	2.699,-
1400-2000 1400-2000 1400-2000	700-1200 500-1100 200-1200	1 swing door with fixed segment 1 swing door 1 short side panel 1 extension kit for U-shaped enclosure		8E5880	8P5880	2.699,-
1400-2000 1400-2000 1400-2000	700-1200 500-1100 200-1200	1 swing door with fixed segment 1 swing door 1 short side panel 1 extension kit for U-shaped enclosure		8E5980	8P5980	2.699,-
to 2000 to 2000	B1: 600-1000 B2: 600-800 B3: 600-800	1 folding swing door - Left-hand fixing 1 folding swing door - Right-hand fixing 2 sealing strips for U-shaped enclosure SFT With handle holes in the door segments for optimum folding function (can be folded completely into the wall). Optionally available with handles as variant 450. The folding function is significantly hindered when using the handles.		8E6480	8P6480	2.326,-
It must be stated whether the specified dimensions refer to the tray installation dimensions or the middle glass installation dimensions (e.g. floor-flush).						
The following therefore needs to be specified in the order with respect to dimensions:						
Refers to the tray installation dimensions: 000						
Refers to the middle glass installation dimensions: 001						

Colours - Panel options

Profile colours	Colour code	Extra charges
White	055	0,-
Matt silver	087	
Black	023	312,-
Grey/brown	061	
Silver high-gloss	092	

Panel options	without Anti-Plaque		with Anti-Plaque	
	Glass code	Extra charges	Glass code	Extra charges
Clear	321	0,-	322	418,-
Grey	301		368	
Bronze	341	371,-	378	789,-
Sand Plus	315		316	

HÜPPE Design pure

Profile colours	Colour code	Extra charges
Black Edition	123	342,-

HÜPPE Design elegance Rectangular HÜPPE Design pure Rectangular

Swing door, rectangular U-shaped enclosure

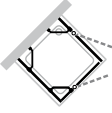
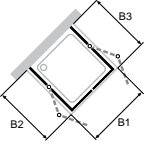
Height	Width	Consisting of:	For ...	elegance	pure	Price
1400-2000	700-1200	1 swing door with fixed segment		8E7880	8P7880	2.699,-
1400-2000	700-1200	1 swing door with fixed segment				
1400-2000	200-1200	1 side panel 1 extension kit for U-shaped enclosure				
to 2000	B1: 600-1000	1 folding swing door with fixed segment - left-hand fixing			8P7680	3.429,-
to 2000	B2: 700-1200 B3: 700-1200	1 folding swing door with fixed segment - right-hand fixing With handle holes in the door segments for optimum folding function.				
It must be stated whether the specified dimensions refer to the tray installation dimensions or the middle glass installation dimensions (e.g. floor-flush).						
The following therefore needs to be specified in the order with respect to dimensions:						
Refers to the tray installation dimensions: 000						
Refers to the middle glass installation dimensions: 001						

Colours - Panel options

Profile colours	Colour code	Extra charges
White	055	0,-
Matt silver	087	
Black	023	312,-
Grey/brown	061	
Silver high-gloss	092	

Panel options	without Anti-Plaque		with Anti-Plaque	
	Glass code	Extra charges	Glass code	Extra charges
Clear	321	0,-	322	418,-
Grey	301	371,-	368	789,-
Bronze	341		378	
Sand Plus	315		316	

HÜPPE Design pure

Profile colours	Colour code	Extra charges
Black Edition	123	342,-

HÜPPE Design elegance Rectangular

HÜPPE Design pure Rectangular

Two-way door, rectangular U-shaped enclosure

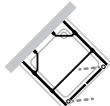
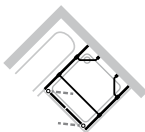
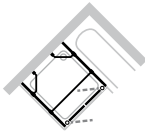
Height	Width	Consisting of:	For ...	elegance	pure	Price
1400-2000 1400-2000	600-1100 200-1200	1 two-way door 2 side panels 1 extension kit for U-shaped enclosure		8E3580	8P3580	2.555,-
1400-2000 1400-2000 1400-2000	600-1100 200-1200 200-1200	1 two-way door 1 short side panel 1 side panel 1 extension kit for U-shaped enclosure		8E4580	8P4580	2.555,-
1400-2000 1400-2000 1400-2000	600-1100 200-1200 200-1200	1 two-way door 1 short side panel 1 side panel 1 extension kit for U-shaped enclosure		8E3480	8P3480	2.555,-

It must be stated whether the specified dimensions refer to the tray installation dimensions or the middle glass installation dimensions (e.g. floor-flush).

The following therefore needs to be specified in the order with respect to dimensions:

Refers to the tray installation dimensions: 000

Refers to the middle glass installation dimensions: 001

Colours - Panel options





Profile colours	Colour code	Extra charges
White	055	0,-
Matt silver	087	
Black	023	312,-
Grey/brown	061	
Silver high-gloss	092	

HÜPPE Design pure

Profile colours	Colour code	Extra charges
Black Edition	123	342,-

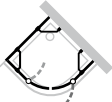
Panel options	without Anti-Plaque		with Anti-Plaque	
	Glass code	Extra charges	Glass code	Extra charges
Clear	321	0,-	322	418,-
Grey	301	371,-	368	789,-
Bronze	341		378	
Sand Plus	315		316	
Privatima	373		375	
Bubbles	376		377	

Swing door, quadrant U-shaped enclosure

Height	Width	Consisting of:	For ...	elegance	pure	Price
1900 1900	750-1100 750-1100	2 quadrant swing door with fixed segments 1 side panel 1 extension kit for U-shaped enclosure		8E3780	8P3780	2.755,-
1900 1900	750-1100 750-1100	2 quadrant swing door with fixed segments 1 side panel 1 extension kit for U-shaped enclosure		8E4780	8P4780	2.755,-
1900 1900	750-1100 750-1100	2 quadrant swing door with fixed segments 1 short side panel 1 extension kit for U-shaped enclosure		8E4680	8P4680	2.755,-
1900 1900	750-1100 750-1100	2 quadrant swing door with fixed segments 1 short side panel 1 extension kit for U-shaped enclosure		8E3680	8P3680	2.755,-
1900 1900 1400-2000	735-1135 800/900/1000 (R500/R550) 200-1200	1 Quadrant swing door with fixed segment 1 quadrant swing door 1 side panel 1 extension kit for U-shaped enclosure		8E6080	8P6080	2.637,-
1900 1900 1400-2000	735-1135 800/900/1000 (R500/R550) 200-1200	1 Quadrant swing door with fixed segment 1 quadrant swing door 1 side panel 1 extension kit for U-shaped enclosure		8E6180	8P6180	2.637,-
It must be stated whether the specified dimensions refer to the tray installation dimensions or the middle glass installation dimensions (e.g. floor-flush).						
The following therefore needs to be specified in the order with respect to dimensions:						
Refers to the tray installation dimensions: 000						
Refers to the middle glass installation dimensions: 001						

Colours - Panel options

Profile colours	Colour code	Extra charges
White	055	0,-
Matt silver	087	
Black	023	312,-
Grey/brown	061	
Silver high-gloss	092	

Panel options	without Anti-Plaque		with Anti-Plaque	
	Glass code	Extra charges	Glass code	Extra charges
Clear	321	0,-	322	418,-
Sand Plus	315	371,-	316	789,-

HÜPPE Design pure

Profile colours	Colour code	Extra charges
Black Edition	123	342,-

HÜPPE Design elegance Quadrant

HÜPPE Design pure Quadrant

Swing door, quadrant U-shaped enclosure

Height	Width	Consisting of:	For ...	elegance	pure	Price
1900	735-1135	1 Quadrant swing door with fixed segment		8E6280	8P6280	2.637,-
1900	800/900/1000 (R500/R550)	1 quadrant swing door				
1400-2000	200-1200	1 short side panel 1 extension kit for U-shaped enclosure				

1900	735-1135	1 Quadrant swing door with fixed segment		8E6380	8P6380	2.637,-
1900	800/900/1000 (R500/R550)	1 quadrant swing door				
1400-2000	200-1200	1 short side panel 1 extension kit for U-shaped enclosure				

It must be stated whether the specified dimensions refer to the tray installation dimensions or the middle glass installation dimensions (e.g. floor-flush).

The following therefore needs to be specified in the order with respect to dimensions:

Refers to the tray installation dimensions: 000

Refers to the middle glass installation dimensions: 001

Colours - Panel options

Profile colours	Colour code	Extra charges
White	055	0,-
Matt silver	087	
Black	023	
Grey/brown	061	312,-
Silver high-gloss	092	

Panel options	without Anti-Plaque		with Anti-Plaque	
	Glass code	Extra charges	Glass code	Extra charges
Clear	321	0,-	322	418,-
Sand Plus	315	371,-	316	789,-

HÜPPE Design pure

Profile colours	Colour code	Extra charges
Black Edition	123	342,-

Swing door, pentagonal U-shaped enclosure

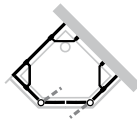
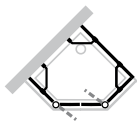
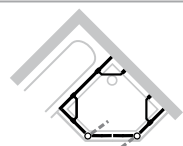
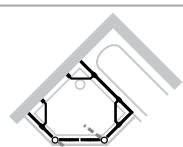
Height	Width	Consisting of:	For ...	elegance	Price
1400-2000	785-1000 785-1000	1 pentagonal swing door with fixed segments 1 side panel 1 extension kit for U-shaped enclosure		8E3980	2.757,-
1400-2000	785-1000 785-1000	1 pentagonal swing door with fixed segments 1 side panel 1 extension kit for U-shaped enclosure		8E4980	2.757,-
1400-2000 to 2000	785-1000 785-1000	1 pentagonal swing door with fixed segments 1 short side panel 1 extension kit for U-shaped enclosure		8E3880	2.757,-
1400-2000 to 2000	785-1000 785-1000	1 pentagonal swing door with fixed segments 1 short side panel 1 extension kit for U-shaped enclosure		8E4880	2.757,-

It must be stated whether the specified dimensions refer to the tray installation dimensions or the middle glass installation dimensions (e.g. floor-flush).

The following therefore needs to be specified in the order with respect to dimensions:

Refers to the tray installation dimensions: 000

Refers to the middle glass installation dimensions: 001

Colours - Panel options

Profile colours	Colour code	Extra charges	Panel options		without Anti-Plaque		with Anti-Plaque	
			Glass code	Extra charges	Glass code	Extra charges		
White	055	0,-	Clear	321	0,-	322	418,-	
Matt silver	087		Grey	301		368		
Black	023	312,-	Bronze	341	371,-	378	789,-	
Grey/brown	061		Sand Plus	315		316		
Silver high-gloss	092							

HÜPPE 501 Design pure swing doors

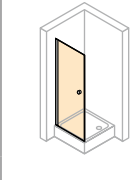
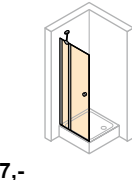
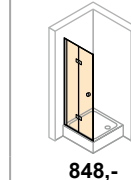
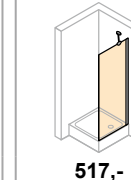
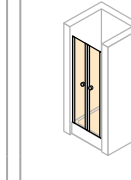
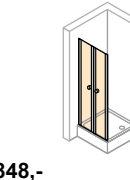
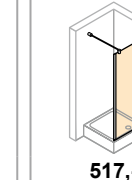

Rectangular

Swing door H.6-H.7  737,-	Swing door with fixed panel H.8-H.9  848,-	Folding swing door H.10-H.13  517,-	Side panel for swing door H.14-H.15  517,-	Two-way door in recess H.16-H.17  848,-	Two-way door for side panel H.18-H.19  517,-	Side panel for two-way door H.20-H.21  517,-
---	---	--	---	--	--	---

Quadrant

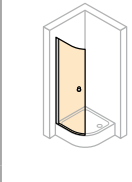
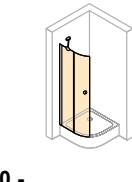
Swing door 2-panel (1/2) H.22-H.23  760,-	Swing door with fixed segments, 2-panel (1/2) H.24-H.25  760,-
---	---

Pentagonal

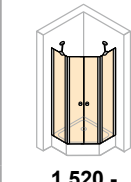
Swing door with fixed segments, 2-panel (1/2) H.26-H.27  1.520,-

Walk-In

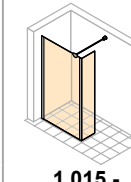
Walk-In side panel with movable segment S.6-S.7  1.015,-
--

Bath-top shower screen

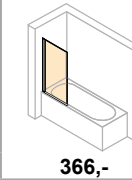
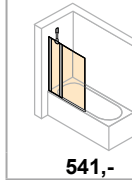
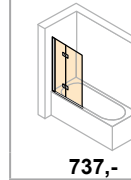
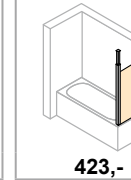
1-panel T.14-T.15  366,-	1-panel with fixed segment T.16-T.17  541,-	Folding swing door T.18-T.19  737,-	Side panel T.20-T.21  423,-
---	---	---	---

U-shaped enclosure

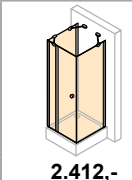
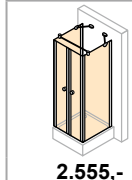
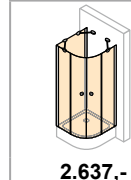
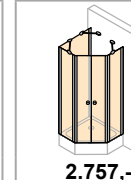
Swing door, rectangular U-shaped enclosure H.29-H.30  2.412,-	Two-way door, rectangular U-shaped enclosure H.31  2.555,-	Swing door, quadrant U-shaped enclosure H.32-H.33  2.637,-	Swing door, pentagonal U-shaped enclosure H.34  2.757,-
---	---	---	--

HÜPPE 501 Design pure swing doors



Product details



High-quality chrome applications:
Handle, stabilizer, cover cap, the folding swinging door hinge and the drip deflector strip are always in chrome or high-gloss silver



Stabilizer



Handle



The powerful rise & fall mechanism lifts the doors by 5mm on opening so that the sealing profiles do not scrape over the floor. The door panel can be fixed in different positions using the raise/lower mechanism.

All models of the HÜPPE 501 Design pure can be optionally installed with a drip deflector strip for optimum tightness or as easy access units

HÜPPE 501 Design pure combination options

+					
=					
<p>780 800 880 900 980 1000</p> <p>700 750 800 900 1000 1200</p>	<p>800 x 800 900 x 900 1000 x 1000 750x800 / 800x750 750x900 / 900x750 750x1000 / 1000x750 780x800 / 800x780 780x900 / 900x780 800x900 / 900x800 800x1000 / 1000x800 880x800 / 800x880 880x900 / 900x880 880x1000 / 1000x880 900x1000 / 1000x900 980x800 / 800x980 980x900 / 900x980 980x1000 / 1000x980</p>	<p>700 x 700 750 x 750 800 x 800 900 x 900 1000 x 1000 700x750 / 750x700 700x800 / 800x700 700x900 / 900x700 700x1000 / 1000x700 700x1200 / 1200x700 750x800 / 800x750 750x900 / 900x750 750x1000 / 1000x750 800x900 / 900x800 800x1000 / 1000x800 800x1200 / 1200x800 900x1000 / 900x800 900x1200 / 1200x900 1000x1200 / 1200x1000</p>	<p>780 x 780 800 x 800 880 x 880 900 x 900 980 x 980 1000 x 1000 780x800 / 800x780 780x880 / 880x780 780x900 / 900x780 780x980 / 980x780 780x1000 / 1000x780 800x880 / 880x800 800x900 / 900x800 800x980 / 980x800 800x1000 / 1000x800 880x900 / 900x880 880x980 / 980x880 880x1000 / 1000x880 900x980 / 980x900 900x1000 / 1000x900 980x1000 / 1000x980</p>	<p>800 x 800 900 x 900 1000 x 1000 700x750 / 750x700 700x800 / 800x700 700x900 / 900x700 700x1000 / 1000x700 700x1200 / 1200x700 750x800 / 800x750 750x900 / 900x750 750x1000 / 1000x750 750x1200 / 1200x750 800x900 / 900x800 800x1000 / 1000x800 800x1200 / 1200x800 900x1000 / 1000x900 900x1200 / 1200x900 1000x1200 / 1200x1000</p>	<p>700 x 700 750 x 750 800 x 800 900 x 900 1000 x 1000 1200 x 1200 700x750 / 750x700 700x800 / 800x700 700x900 / 900x700 700x1000 / 1000x700 700x1200 / 1200x700 750x800 / 800x750 750x900 / 900x750 750x1000 / 1000x750 750x1200 / 1200x750 800x900 / 900x800 800x1000 / 1000x800 800x1200 / 1200x800 900x1000 / 1000x900 900x1200 / 1200x900 1000x1200 / 1200x1000</p>

+		
=		
<p>800 900 1000</p>	<p>800 900 1000</p>	<p>800 900 1000</p>
<p>800 x 800 900 x 900 1000 x 1000 800 x 900 / 900 x 800 800 x 1000 / 1000 x 800 900 x 1000 / 1000 x 900</p>	<p>800 x 800 900 x 900 1000 x 1000 800 x 900 / 900 x 800 800 x 1000 / 1000 x 800 900 x 1000 / 1000 x 900</p>	<p>800 x 800 900 x 900 1000 x 1000 800 x 900 / 900 x 800 800 x 1000 / 1000 x 800 900 x 1000 / 1000 x 900</p>

HÜPPE 501 Design pure Rectangular

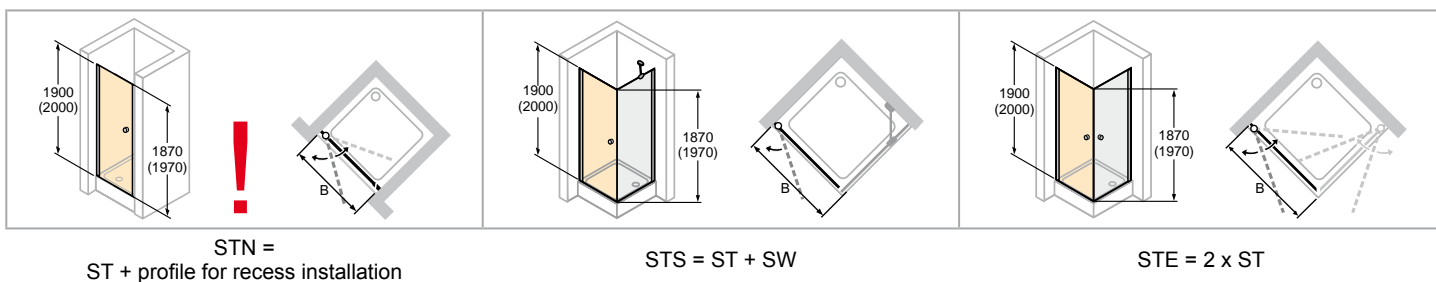
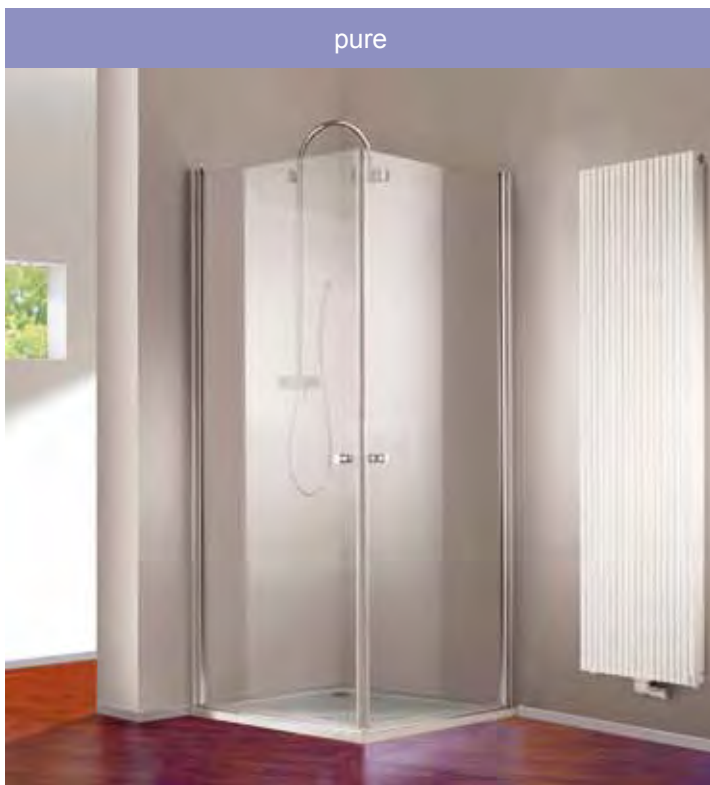

! Recess profile is required for swing doors in recess or door combined with shortened side panel.

- STS: Only outwards opening. Inwards opening also possible with inwards/outwards opening supplement set.
- Sloping sections possible. For recess solutions always with straight cut profile on closing side.

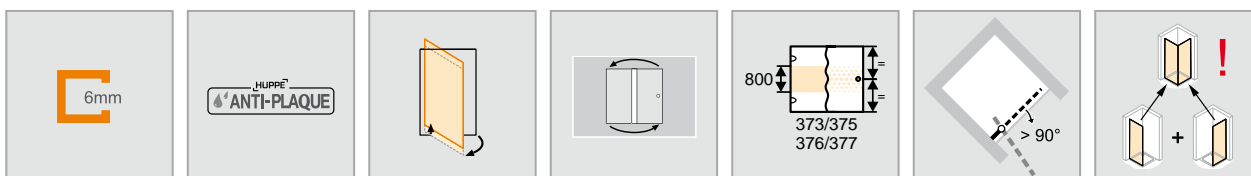
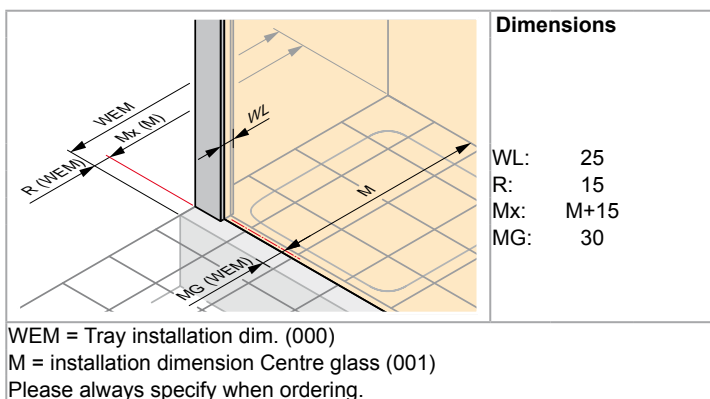

Swing door

Height	Model	WEM STN	WEM STS/STE	M (middle of glass) STN	M (middle of glass) STS/STE	Entry width STN/STS	Entry width STE	pure	Base price
1900	780	765-795	765-780	765-795	735-750	665	932	510401	737,-
	800	785-815	785-800	785-815	755-770	685	960	510600	
	880	865-895	865-880	865-895	835-850	765	1072	510402	
	900	885-915	885-900	885-915	855-870	785	1100	510601	
	980	965-995	965-980	965-995	935-950	865	1214	510403	
2000	1000	985-1015	985-1000	985-1015	955-970	885	1242	510602	766,-
	780	765-795	765-780	765-795	735-750	665	932	510404	811,-
	800	785-815	785-800	785-815	755-770	685	960	510604	
	880	865-895	865-880	865-895	835-850	765	1072	510408	
	900	885-915	885-900	885-915	855-870	785	1100	510605	
980	965-995	965-980	965-995	935-950	865	1214	510409		
	1000	985-1015	985-1000	985-1015	955-970	885	1242	510606	844,-

NOTE: The complete corner entry consists of two item nos.

Made-to-measure

Height	Width B	pure	Base price
1400-2000	500-1100	510609	957,-



Adjustment range STN = dimensions - 8mm / + 22mm

Adjustment range STS/STE = dimensions - 8mm / + 7mm

Slopes and cut-outs

Slopes and cut-outs	Extra charges
 Supplement per slope/cut-out for made-to-measure	170,-

Dim. Range: min. - max.

	
1400-2000	500-1100

Extras

Height	Profile	pure	Price
1900	Extension profile, 15mm	178002	32,-
	Profile for recess installation	510699	119,-
2000	Extension profile, 15mm	178006	32,-
	Profile for recess installation	510693	119,-
	Inwards/outwards opening supplement set (can be shortened on site). Only suitable for 6mm door and side panel.	ZB0001	
	Inwards/outwards opening supplement set (can be shortened on site). Only suitable for 6mm door and 8mm side panel.	ZB0002	
to 2000	Profile for recess installation, made-to-measure	510698	

Colours - Panel options

Profile colours	Colour code	Extra charges	Panel options	without Anti-Plaque		with Anti-Plaque	
				Glass code	Extra charges	Glass code	Extra charges
White	055	0,-	Clear	321	0,-	322	209,-
Matt silver	087		Grey	301		368	
Black	023	156,-	Bronze	341	378		
Grey/brown	061		Sand Plus	315	316		
Silver high-gloss	092		Privatima	373	375		
			Bubbles	376	377		

HÜPPE 501 Design pure Rectangular

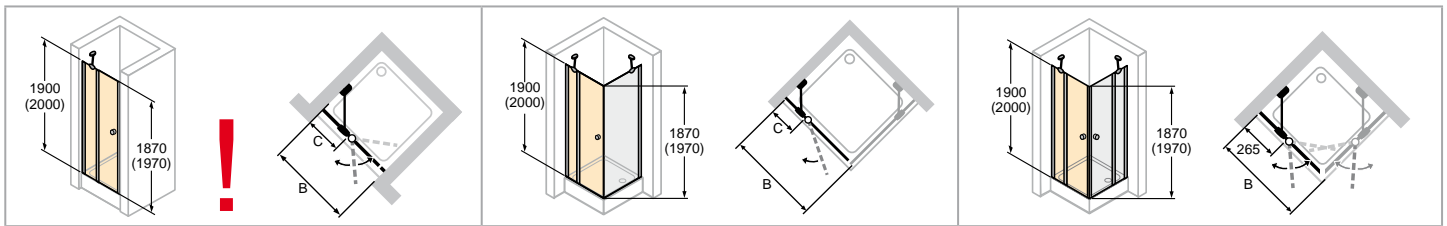

STN with fixed segment = ST with fixed segment + supplement set

C = 261-276
C = 461-476 (ST 1200)

STS with fixed segment = ST with fixed segment + SW

C = 261-276
C = 461-476 (ST 1200)

STE with fixed segment = 2 x ST with fixed segment

C = 261-276
C = 461-476 (ST 1200)

! Recess profile is required for swing doors in recess or door combined with shortened side panel.

Glass 373/375 Privatima: Specification in the order whether left-hand or right-hand fixing.

- STS: Only outwards opening. Inwards opening also possible with inwards/outwards opening supplement set.
- Sloping sections possible. For recess solutions always with straight cut profile on closing side.

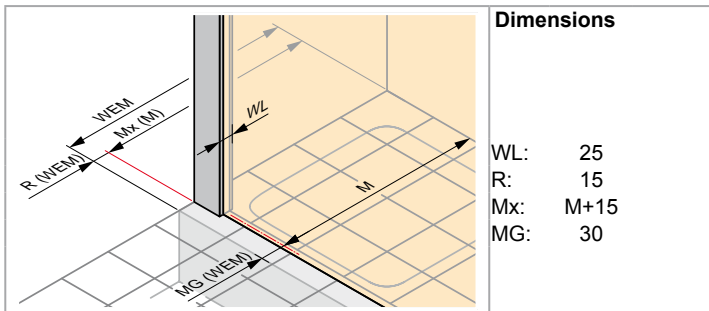

WEM = Tray installation dim. (000)
M = installation dimension Centre glass (001)
Please always specify when ordering.

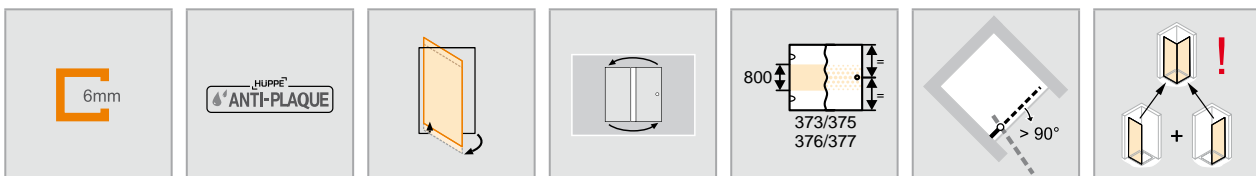

Swing door with fixed panel

Height	Model	WEM STN	WEM STS/STE	M (middle of glass) STN	M (middle of glass) STS/STE	Entry width STN/STS	Entry width STE	pure	Base price
1900	780	765-795	765-780	765-795	735-750	470	655	510491	737,-
	800	785-815	785-800	785-815	755-770	470	655	510610	
	880	865-895	865-880	865-895	835-850	570	799	510492	
	900	885-915	885-900	885-915	855-870	570	799	510611	766,-
	980	965-995	965-980	965-995	935-950	670	940	510493	
	1000	985-1015	985-1000	985-1015	955-970	670	940	510612	
2000	1200	1185-1215	1185-1200	1185-1215	1155-1170	670	940	510613	794,-
	780	765-795	765-780	765-795	735-750	470	655	510494	811,-
	800	785-815	785-800	785-815	755-770	470	655	510614	
	880	865-895	865-880	865-895	835-850	570	799	510495	
	900	885-915	885-900	885-915	855-870	570	799	510615	844,-
	980	965-995	965-980	965-995	935-950	670	940	510496	
	1000	985-1015	985-1000	985-1015	955-970	670	940	510616	
	1200	1185-1215	1185-1200	1185-1215	1155-1170	670	940	510617	876,-

NOTE: The complete corner entry consists of two item nos.

Made-to-measure





Height	Width B	pure	Base price
1400-2000	700-1550	510619	957,-

Adjustment range STN = dimensions - 8mm / + 22mm
 Adjustment range STS/STE = dimensions - 8mm / + 7mm
 From widths of 1300mm with cross bar.
 If more than 1300mm wide, side panel max. 1100mm.

Slopes and cut-outs

Slopes and cut-outs	Extra charges
 Supplement per slope/cut-out for made-to-measure	170,-

Dim. Range: min. - max.

			
1400-2000	700-1550	230-650	max. 900

Extras

Height	Profile	pure	Price
1900	Extension profile, 15mm	178003	32,-
	Profile for recess installation	510699	119,-
2000	Extension profile, 15mm	178007	32,-
	Profile for recess installation	510693	119,-
	Inwards/outwards opening supplement set (can be shortened on site). Only suitable for 6mm door and side panel.	ZB0001	
	Inwards/outwards opening supplement set (can be shortened on site). Only suitable for 6mm door and 8mm side panel.	ZB0002	
to 2000	Profile for recess installation, made-to-measure	510698	

Colours - Panel options

Profile colours	Colour code	Extra charges	Panel options		without Anti-Plaque		with Anti-Plaque	
			Glass code	Extra charges	Glass code	Extra charges		
White	055	0,-	Clear	321	0,-	322	209,-	
Matt silver	087		Grey	301	186,-	368	395,-	
Black	023		Bronze	341		378		
Grey/brown	061		Sand Plus	315		316		
Silver high-gloss	092		Privatima	373		375		
		Bubbles	376	377				

HÜPPE 501 Design pure Rectangular

pure

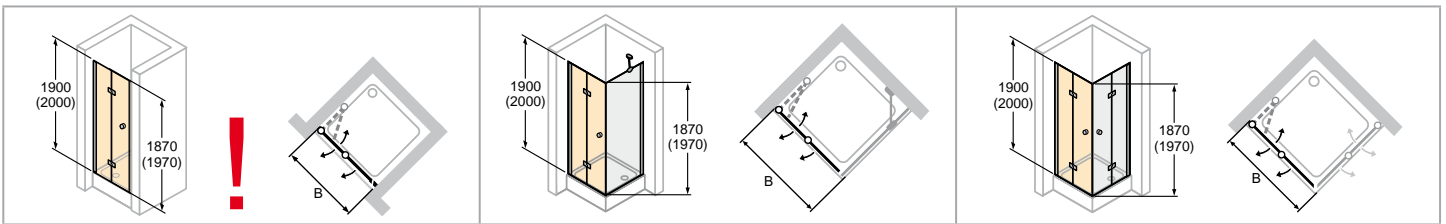

SFTN =
SFT + profile for recess installation

SFTS = SFT + SW

SFTE = 2 x SFT

! Recess profile is required for folding swing doors in recess or door combined with shortened side panel.

• Sloping sections possible. For recess solutions always with straight cut profile on closing side.

Dimensions

WL: 25
R: 15
Mx: M+15
MG: 30

WEM = Tray installation dim. (000)
M = installation dimension Centre glass (001)
Please always specify when ordering.

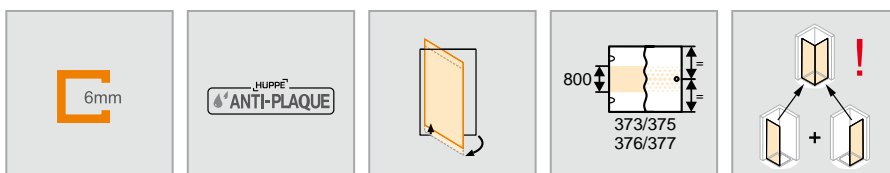

Folding swing door

Left-hand fixing

Height	Model	WEM SFTN	WEM SFTS/SFTE	M (middle of glass) SFTN	M (middle of glass) SFTS/SFTE	Entry width SFTS/SFTN	Entry width SFTE	pure	Base price
1900	700	685-715	685-700	685-715	655-670	560	800	510953	848,-
	750	735-765	735-750	735-765	705-720	610	870	510954	
	800	785-815	785-800	785-815	755-770	660	950	510950	
	900	885-915	885-900	885-915	855-870	760	1100	510951	
	1000	985-1015	985-1000	985-1015	955-970	860	1240	510952	
2000	1200	1185-1215	1185-1200	1185-1215	1155-1170	1060	1380	510955	899,-
	700	685-715	685-700	685-715	655-670	560	800	510943	933,-
	750	735-765	735-750	735-765	705-720	610	870	510944	
	800	785-815	785-800	785-815	755-770	660	950	510940	
	900	885-915	885-900	885-915	855-870	760	1100	510941	
	1000	985-1015	985-1000	985-1015	955-970	860	1240	510942	
1200	1185-1215	1185-1200	1185-1215	1155-1170	1060	1380	510945	971,-	
NOTE: The complete corner entry consists of two item nos.									988,-

Made-to-measure - Left-hand fixing

Height	Width B	pure	Base price
1400-2000	500-1250	510959	1.101,-

Adjustment range SFTN = dimensions - 8mm / + 22mm
 Adjustment range SFTS/SFTE = dimensions - 8mm / + 7mm

	Model	Folded width F	Profile thickness P	Model	Folded width F	Profile thickness P
	SFT 700	340	95-110	SFT 900	440	95-110
	SFT 750	365	95-110	SFT 1000	490	95-110
	SFT 800	390	95-110	SFT 1200	590	95-110

Slopes and cut-outs

Slopes and cut-outs	Extra charges
	Supplement per slope/cut-out for made-to-measure 170,-

Dim. Range: min. - max.

1400-2000	500-1250

Extras

Height	Profile	pure	Price
1900	Extension profile, 15mm	178002	32,-
	Profile for recess installation	510699	119,-
2000	Extension profile, 15mm	178006	32,-
	Profile for recess installation	510693	119,-
to 2000	Profile for recess installation, made-to-measure	510698	

Colours - Panel options

Profile colours	Colour code	Extra charges	Panel options	without Anti-Plaque		with Anti-Plaque	
				Glass code	Extra charges	Glass code	Extra charges
White	055	0,-	Clear	321	186,-	322	209,-
Matt silver	087		Grey	301		368	
Black	023		Bronze	341		378	
Grey/brown	061		Sand Plus	315		316	
Silver high-gloss	092		Privatima	373		375	
			Bubbles	376	377		

HÜPPE 501 Design pure Rectangular

pure

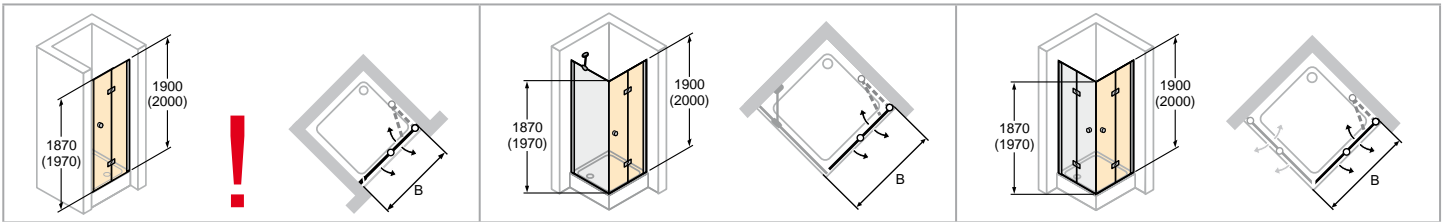

SFTN =
SFT + profile for recess installation

SFTS = SFT + SW

SFTE = 2 x SFT

- ! **Recess profile is required for folding swing doors in recess or door combined with shortened side panel.**
- Sloping sections possible. For recess solutions always with straight cut profile on closing side.

Dimensions

WL: 25
R: 15
Mx: M+15
MG: 30

WEM = Tray installation dim. (000)
M = installation dimension Centre glass (001)
Please always specify when ordering.

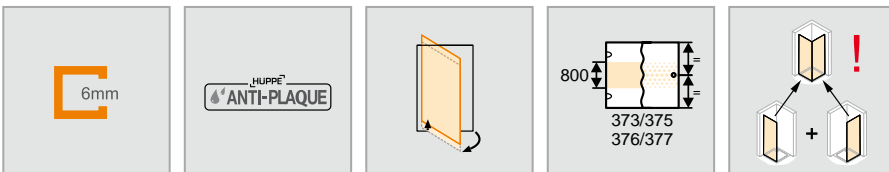

Folding swing door

Right-hand fixing

Height	Model	WEM SFTN	WEM SFTS/SFTE	M (middle of glass) SFTN	M (middle of glass) SFTS/SFTE	Entry width SFTS/SFTN	Entry width SFTE	pure	Base price
1900	700	685-715	685-700	685-715	655-670	560	800	510963	848,-
	750	735-765	735-750	735-765	705-720	610	870	510964	
	800	785-815	785-800	785-815	755-770	660	950	510960	
	900	885-915	885-900	885-915	855-870	760	1100	510961	
	1000	985-1015	985-1000	985-1015	955-970	860	1240	510962	
	1200	1185-1215	1185-1200	1185-1215	1155-1170	1060	1380	510965	899,-
2000	700	685-715	685-700	685-715	655-670	560	800	510973	933,-
	750	735-765	735-750	735-765	705-720	610	870	510974	
	800	785-815	785-800	785-815	755-770	660	950	510970	
	900	885-915	885-900	885-915	855-870	760	1100	510971	
	1000	985-1015	985-1000	985-1015	955-970	860	1240	510972	
	1200	1185-1215	1185-1200	1185-1215	1155-1170	1060	1380	510975	988,-

NOTE: The complete corner entry consists of two item nos.

Made-to-measure - Right-hand fixing

Height	Width B	pure	Base price
1400-2000	500-1250	510969	1.101,-

Adjustment range SFTN = dimensions - 8mm / + 22mm

Adjustment range SFTS/SFTE = dimensions - 8mm / + 7mm

	Model	Folded width F	Profile thickness P	Model	Folded width F	Profile thickness P
	SFT 700	340	95-110	SFT 900	440	95-110
	SFT 750	365	95-110	SFT 1000	490	95-110
	SFT 800	390	95-110	SFT 1200	590	95-110

Slopes and cut-outs

Slopes and cut-outs	Extra charges
	Supplement per slope/cut-out for made-to-measure 170,-

Dim. Range: min. - max.

1400-2000	500-1250

Extras

Height	Profile	pure	Price
1900	Extension profile, 15mm	178002	32,-
	Profile for recess installation	510699	119,-
2000	Extension profile, 15mm	178006	32,-
	Profile for recess installation	510693	119,-
to 2000	Profile for recess installation, made-to-measure	510698	

Colours - Panel options

Profile colours	Colour code	Extra charges	Panel options	without Anti-Plaque		with Anti-Plaque	
				Glass code	Extra charges	Glass code	Extra charges
White	055	0,-	Clear	321	0,-	322	209,-
Matt silver	087		Grey	301		368	
Black	023	156,-	Bronze	341	186,-	378	395,-
Grey/brown	061		Sand Plus	315		316	
Silver high-gloss	092		Privatima	373		375	
			Bubbles	376		377	

HÜPPE 501 Design pure Rectangular

pure

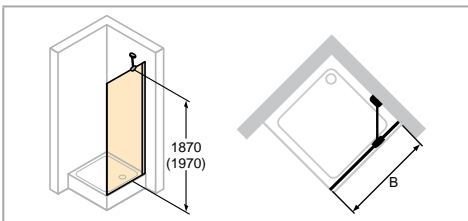
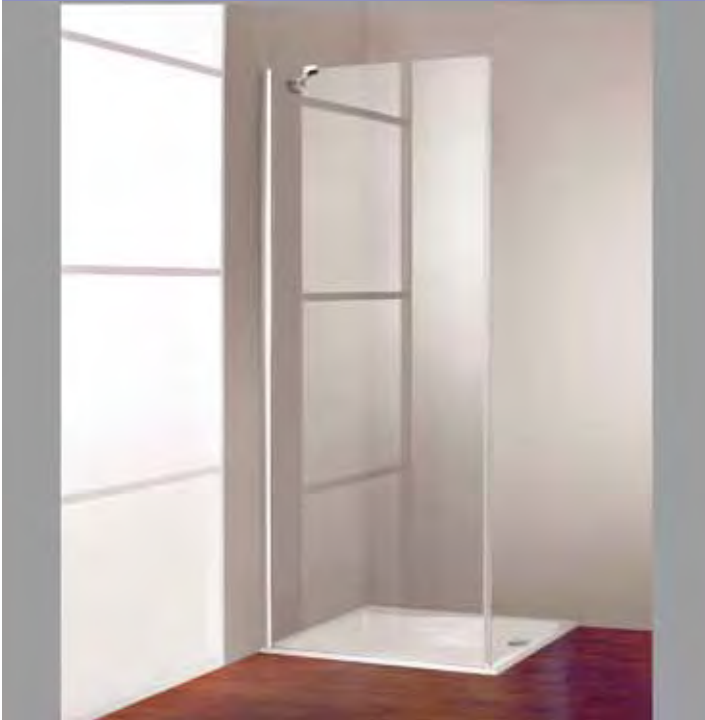

- Side panel can be combined with swing door, swing door with fixed segment and swing folding door.
- Shortened side panel can only be combined with door in recess. Niche installation kit required.
- Towel rail height can be selected individually and must be specified with the order. If nothing is specified, the towel rail is always delivered middle of glass (height and width).

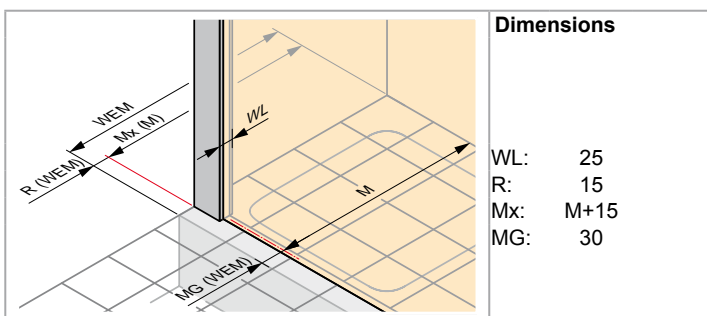

Dimensions

WL: 25
R: 15
Mx: M+15
MG: 30

WEM = Tray installation dim. (000)
M = installation dimension Centre glass (001)
Please always specify when ordering.

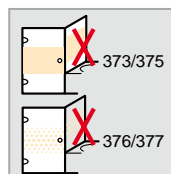
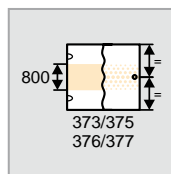
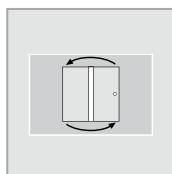
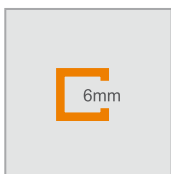

Side panel for swing door

Height	Model	WEM B	M (middle of glass) B	pure	Base price
1900	SW 700	685-700	655-670	510624	517,-
	SW 750	735-750	705-720	510620	
	SW 800	785-800	755-770	510621	
	SW 900	885-900	855-870	510622	
	SW 1000	985-1000	955-970	510623	
2000	SW 700	685-700	655-670	510524	569,-
	SW 750	735-750	705-720	510520	
	SW 800	785-800	755-770	510521	
	SW 900	885-900	855-870	510522	
	SW 1000	985-1000	955-970	510523	
1650	SWK 700	685-700	655-670	510800	517,-
	SWK 750	735-750	705-720	510801	
	SWK 800	785-800	755-770	510802	
	SWK 900	885-900	855-870	510803	
1750	SWK 700	685-700	655-670	510530	517,-
	SWK 750	735-750	705-720	510531	
	SWK 800	785-800	755-770	510532	
	SWK 900	885-900	855-870	510533	

Made-to-measure

Height	Model	Width B	Fixing	pure	Base price
500-2000	Standard made-to-measure	200-1200	Stabilizer	510629	671,-
	In-line configuration	200-1200	Cross-bracing	510628	
	On bath tub - only with door in recess	200-1200	Stabilizer	510627	

Adjustment range = dimensions - 8mm / + 7mm

Slopes and cut-outs

Slopes and cut-outs	Extra charges
 Supplement per slope/cut-out for made-to-measure	170,-

Dim. Range: min. - max.

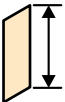
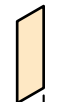
	
500-2000	200-1200

Special options

Special options	Extra charges
Towel rail (silver high-gloss)	210,-

Colours - Panel options

Profile colours	Colour code	Extra charges	Panel options		without Anti-Plaque		with Anti-Plaque	
			Glass code	Extra charges	Glass code	Extra charges		
White	055	0,-	Clear	321	0,-	322	209,-	
Matt silver	087		Grey	301		368		
Silver high-gloss	092	114,-	Bronze	341		378		
Black	023	156,-	Sand Plus	315	186,-	316	395,-	
Grey/brown	061		Privatima	373		375		
			Bubbles	376		377		

HÜPPE 501 Design pure Rectangular

pure

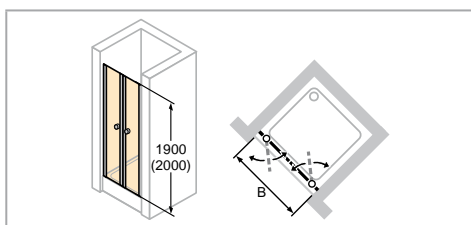

	Dimensions
	<p>WL: 25 R: 15 Mx: M+15 MG: 30</p>
<p>WEM = Tray installation dim. (000) M = installation dimension Centre glass (001) Please always specify when ordering.</p>	

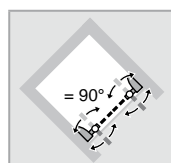
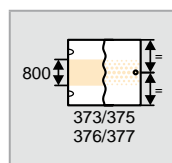
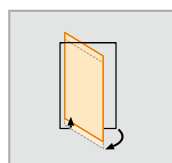
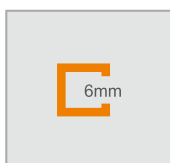

Two-way door in recess

Height	Model	WEM B	M (middle of glass) B	Entry width	pure	Base price
1900	780	760-785	760-785	620	510930	848,-
	800	780-805	780-805	640	510630	
	880	860-885	860-885	720	510931	
	900	880-905	880-905	740	510631	882,-
	980	960-985	960-985	820	510932	
	1000	980-1005	980-1005	840	510632	
2000	780	760-785	760-785	620	510934	933,-
	800	780-805	780-805	640	510634	
	880	860-885	860-885	720	510935	
	900	880-905	880-905	740	510635	971,-
	980	960-985	960-985	820	510936	
	1000	980-1005	980-1005	840	510636	

Made-to-measure

Height	Model	Width B	pure	Base price
1400-2000	Standard made-to-measure	500-1800	510639	1.101,-

Adjustment range = dimensions - 13mm / + 12mm

Dim. Range: min. - max.

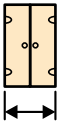
	
1400-2000	500-1800

Extras

Height	Profile	pure	Price
1900		178002	32,-
2000		178006	

Colours - Panel options

Profile colours	Colour code	Extra charges	Panel options		without Anti-Plaque		with Anti-Plaque	
			Glass code	Extra charges	Glass code	Extra charges		
White	055	0,-	Clear	321	0,-	322	209,-	
Matt silver	087		Grey	301	186,-	368	395,-	
Black	023	Bronze	341	378				
Grey/brown	061	Sand Plus	315	316				
Silver high-gloss	092	Privatima	373	375				
		Bubbles	376	377				

HÜPPE 501 Design pure Rectangular

pure

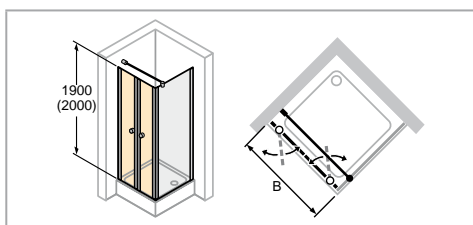
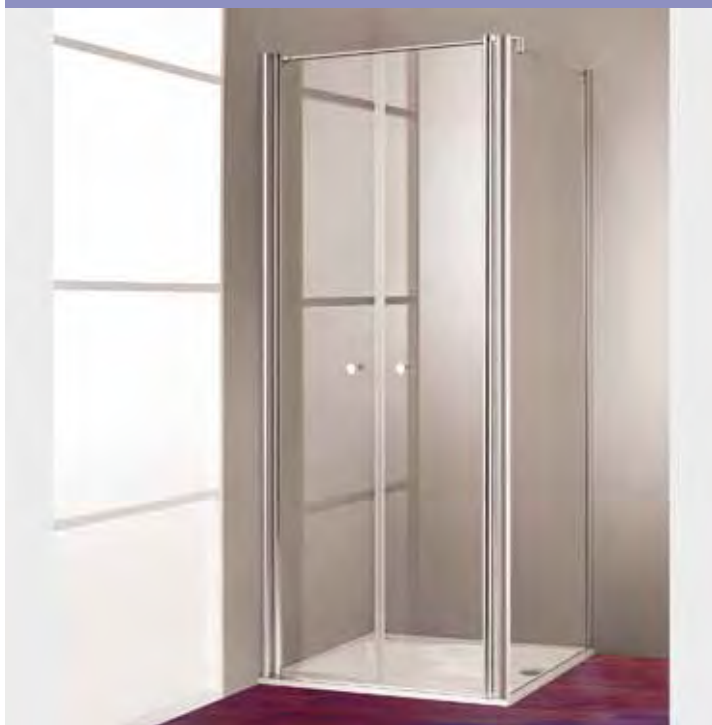

Dimensions	
WL:	25
R:	15
Mx:	M+15
MG:	30

WEM = Tray installation dim. (000)
M = installation dimension Centre glass (001)
Please always specify when ordering.

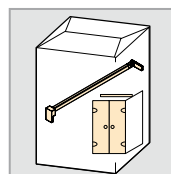
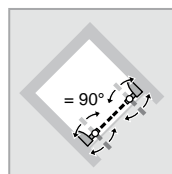
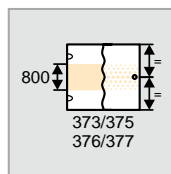
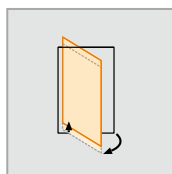
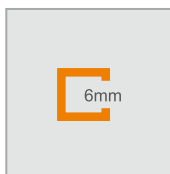

Two-way door for side panel

Height	Model	WEM B	M (middle of glass) B	Entry width	pure	Base price
1900	800	775-805	745-775	600	510640	848,-
	900	875-905	845-875	700	510641	
	1000	975-1005	945-975	800	510642	882,-
2000	800	775-805	745-775	600	510644	933,-
	900	875-905	845-875	700	510645	
	1000	975-1005	945-975	800	510646	971,-

Made-to-measure

Height	Model	Width B	pure	Base price
1400-2000	Standard made-to-measure	500-1600	510649	1.101,-

Adjustment range = dimensions - 15mm / + 15mm

Dim. Range: min. - max.

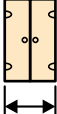
	
1400-2000	500-1600

Extras

Height	Profile	pure	Price
1900		178002	32,-
2000		178006	

Colours - Panel options

Profile colours	Colour code	Extra charges	Panel options	without Anti-Plaque		with Anti-Plaque	
				Glass code	Extra charges	Glass code	Extra charges
White	055	0,-	Clear	321	0,-	322	209,-
Matt silver	087		Grey	301		368	
Black	023	156,-	Bronze	341		378	
Grey/brown	061		Sand Plus	315	186,-	316	395,-
Silver high-gloss	092		Privatima	373		375	
			Bubbles	376		377	

HÜPPE 501 Design pure Rectangular

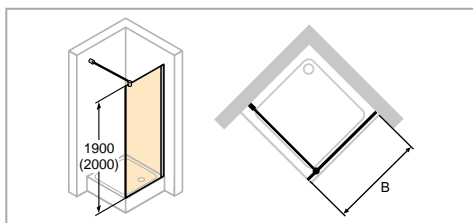

- Shortened side panel (SWK) can only be combined with door in recess.
- Towel rail height can be selected individually and must be specified with the order. If nothing is specified, the towel rail is always delivered middle of glass (height and width).

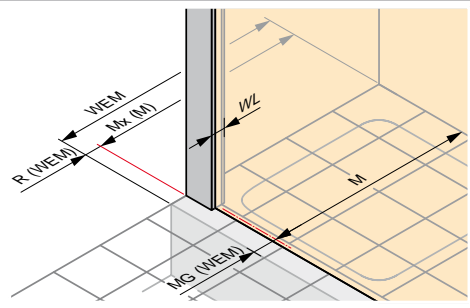

Dimensions

WL: 25
R: 15
Mx: M+15
MG: 30

WEM = Tray installation dim. (000)
M = installation dimension Centre glass (001)
Please always specify when ordering.

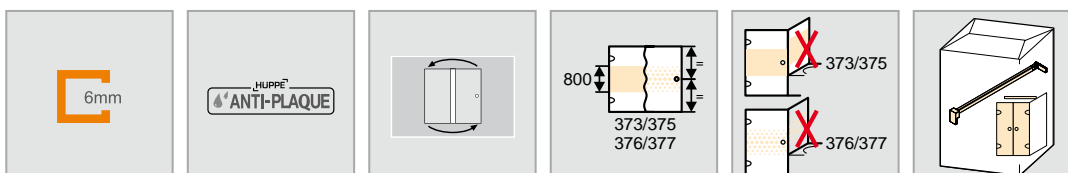

Side panel for two-way door

Height	Model	WEM B	M (middle of glass) B	pure	Base price
1900	SW 700	685-700	655-670	510784	517,-
	SW 750	735-750	705-720	510780	
	SW 800	785-800	755-770	510781	
	SW 900	885-900	855-870	510782	
	SW 1000	985-1000	955-970	510783	538,-
2000	SW 700	685-700	655-670	510554	569,-
	SW 750	735-750	705-720	510550	
	SW 800	785-800	755-770	510551	
	SW 900	885-900	855-870	510552	
	SW 1000	985-1000	955-970	510553	591,-
1650	SWK 700	685-700	655-670	510790	517,-
	SWK 750	735-750	705-720	510791	
	SWK 800	785-800	755-770	510792	
	SWK 900	885-900	855-870	510793	
1750	SWK 700	685-700	655-670	510560	
	SWK 750	735-750	705-720	510561	
	SWK 800	785-800	755-770	510562	
	SWK 900	885-900	855-870	510563	

Made-to-measure



Height	Model	Width B	pure	Base price
500-2000	Standard made-to-measure	200-1200	510789	671,-
	On bath tub - only with two way door in recess (PTN)	200-1200	510786	

Adjustment range = dimensions - 8mm / + 7mm

Slopes and cut-outs

Slopes and cut-outs	Extra charges
 Supplement per slope/cut-out for made-to-measure	170,-

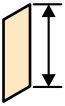
Dim. Range: min. - max.

	
500-2000	200-1200

Special options

Special options	Extra charges
Towel rail (silver high-gloss)	T99 210,-

Colours - Panel options

Profile colours	Colour code	Extra charges	Panel options		without Anti-Plaque		with Anti-Plaque	
			Glass code	Extra charges	Glass code	Extra charges		
White	055	0,-	Clear	321	0,-	322	209,-	
Matt silver	087		Grey	301		368		
Silver high-gloss	092	114,-	Bronze	341		378		
Black	023	156,-	Sand Plus	315	186,-	316	395,-	
Grey/brown	061		Privatima	373		375		
			Bubbles	376		377		

HÜPPE 501 Design pure Quadrant

pure

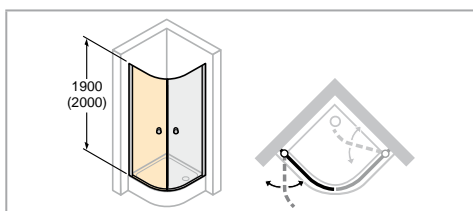

▪ No made-to-measure possible.

Dimensions	
WL:	25
R:	15
Mx:	M+15
MG:	30

WEM = Tray installation dim. (000)
M = installation dimension Centre glass (001)
Please always specify when ordering.

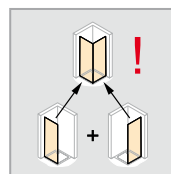
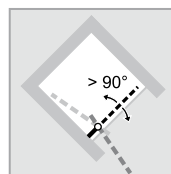
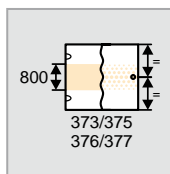
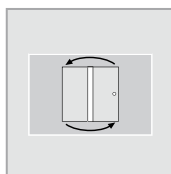
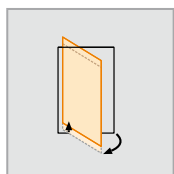
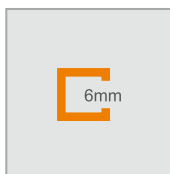

Swing door 2-panel (1/2)

Height	Model	WEM	M (middle of glass)	Entry width	Radius	pure	Base price
1900	800	785-800	755-770	1131	500	510650	760,-
	900	885-900	855-870	1273	500	510651	
	1000	985-1000	955-970	1414	500	510652	790,-
	800	785-800	755-770	1131	550	510660	760,-
	900	885-900	855-870	1273	550	510661	
	1000	985-1000	955-970	1414	550	510662	790,-
2000	800	785-800	755-770	1131	500	510653	836,-
	900	885-900	855-870	1273	500	510654	
	1000	985-1000	955-970	1414	500	510655	868,-
	800	785-800	755-770	1131	550	510663	836,-
	900	885-900	855-870	1273	550	510664	
	1000	985-1000	955-970	1414	550	510665	868,-

NOTE: Price, item no. per panel.

Dim. Range: min. - max.

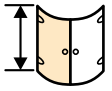
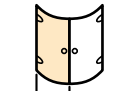
	
1900/2000	800/900/1000 (R500/R550)

Extras

Height		Profile	pure	Price
1900	Extension profile, 15mm		178002	32,-
2000			178006	

Colours - Panel options

Profile colours	Colour code	Extra charges	Panel options		without Anti-Plaque		with Anti-Plaque	
			Glass code	Extra charges	Glass code	Extra charges		
White	055	0,-	Clear	321	0,-	322	209,-	
Matt silver	087		Sand Plus	315		316		
Black	023	156,-	Privatima	373	186,-	375	395,-	
Grey/brown	061		Bubbles	376		377		
Silver high-gloss	092							

HÜPPE 501 Design pure Quadrant

pure

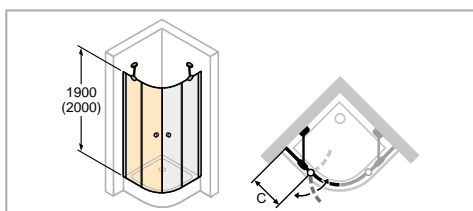

Glass 373/375 Privatima: Specification in the order whether left-hand or right-hand fixing.

Dimensions	
	WL: 25 R: 15 Mx: M+15 MG: 30
WEM = Tray installation dim. (000) M = installation dimension Centre glass (001) Please always specify when ordering.	

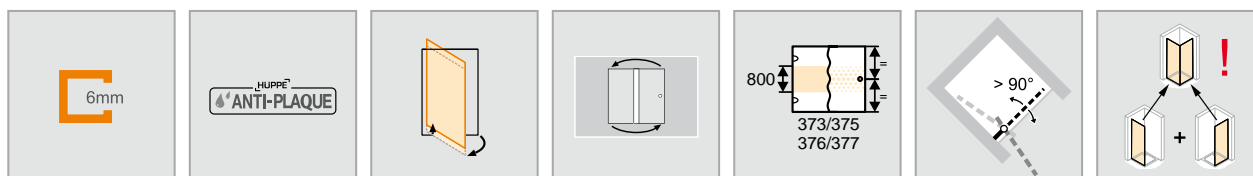

Swing door with fixed segments, 2-panel (1/2)

Height	Model	WEM	M (middle of glass)	Entry width	C	Radius	pure	Base price	
1900	800	785-800	755-770	630	280-295	500	510670	760,-	
	900	885-900	855-870	630	380-395	500	510671		
	1000	985-1000	955-970	630	480-495	500	510672		
	2000	800	785-800	755-770	685	235-250	550	510680	760,-
		900	885-900	855-870	685	335-350	550	510681	
		1000	985-1000	955-970	685	435-450	550	510682	
2000		800	785-800	755-770	630	280-295	500	510673	836,-
		900	885-900	855-870	630	380-395	500	510674	
		1000	985-1000	955-970	630	480-495	500	510675	868,-
	800	785-800	755-770	685	235-250	550	510683	836,-	
900	885-900	855-870	685	335-350	550	510684	868,-		
1000	985-1000	955-970	685	435-450	550	510685		868,-	

NOTE: Price, item no. per panel.

Made-to-measure

Height	Width	C	Radius	pure	Base price
1900/2000	735-1135	200-600	500	510679	986,-
	735-1135	200-600	550	510689	

Made-to-measure available for width only

Adjustment range = dimensions - 8mm / + 7mm

Slopes and cut-outs

Slopes and cut-outs	Extra charges
	Supplement per slope/cut-out for made-to-measure 170,-

Dim. Range: min. - max.

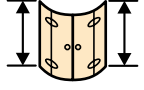
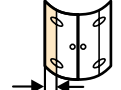
	
1900/2000	200-600

Extras

Height	Profile	pure	Price
1900		178003	32,-
2000		178007	

Colours - Panel options

Profile colours	Colour code	Extra charges	Panel options		without Anti-Plaque		with Anti-Plaque	
			Glass code	Extra charges	Glass code	Extra charges		
White	055	0,-	Clear	321	0,-	322	209,-	
Matt silver	087		Sand Plus	315		316		
Black	023		Privatima	373	186,-	375	395,-	
Grey/brown	061		Bubbles	376		377		
Silver high-gloss	092							

HÜPPE 501 Design pure Pentagonal

pure

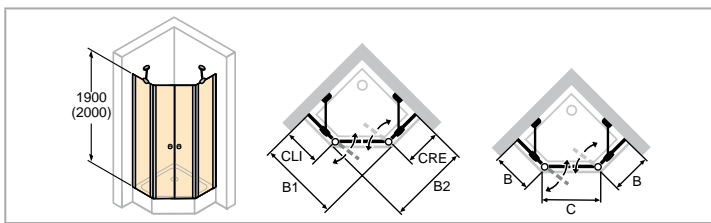

	<p>Dimensions</p> <p>WL: 25 R: 15 Mx: M+15 MG: 30</p>
<p>WEM = Tray installation dim. (000) M = installation dimension Centre glass (001) Please always specify when ordering.</p>	

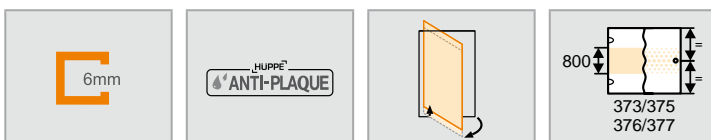

Swing door with fixed segments, 2-panel

Height	Model B1/B2	WEM B1/B2	M (middle of glass) B1/B2	CLI	CRE	B	C	Entry width	pure	Base price
1900	900 x 900	885-900/ 885-900	855-870	449-464	449-464	475	600	543	510710	1.520,-
	900 x 900	885-900/ 885-900	855-870	424-439	424-439	450	636	578	510700	
	1000 x 1000	985-1000/ 985-1000	955-970	509-524	509-524	535	657	599	510760	1.581,-
	1000 x 1000	985-1000/ 985-1000	955-970	474-489	474-489	500	707	649	510750	
2000	900 x 900	885-900/ 885-900	855-870	449-464	449-464	475	600	543	510730	1.671,-
	900 x 900	885-900/ 885-900	855-870	424-439	424-439	450	636	578	510720	
	1000 x 1000	985-1000/ 985-1000	955-970	509-524	509-524	535	657	599	510770	1.739,-
	1000 x 1000	985-1000/ 985-1000	955-970	474-489	474-489	500	707	649	510740	

Made-to-measure





Height	Model	Width	CLI	CRE	Entry width	pure	Base price
1400-2000	Shower tray	785-1090	200-600	200-600	543	510739	1.975,-
	Shower tray	785-1090	200-600	200-600	578	510729	
	Shower tray	785-1090	200-600	200-600	599	510779	
	Shower tray	785-1090	200-600	200-600	649	510749	
	Floor-flush	785-1090	200-600	200-600	543-649	510708	

Adjustment range = dimensions - 8mm / + 7mm

Slopes and cut-outs

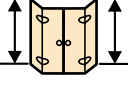
Slopes and cut-outs	Extra charges
 <p>Supplement per slope/cut-out for made-to-measure</p>	170,-

Dim. Range: min. - max.

				
1400-2000	200-600	785-1090	785-1090	200-600

Extras

Height	Profile	pure	Price
1900		178003	32,-
2000		178007	

Colours - Panel options

Profile colours	Colour code	Extra charges	Panel options	without Anti-Plaque		with Anti-Plaque	
				Glass code	Extra charges	Glass code	Extra charges
White	055	0,-	Clear	321	0,-	322	418,-
Matt silver	087		Grey	301		368	
Black	023	312,-	Bronze	341		378	
Grey/brown	061		Sand Plus	315	371,-	316	789,-
Silver high-gloss	092		Privatima	373		375	
			Bubbles	376		377	

HÜPPE 501 Design pure U-shaped enclosure



Swing door, rectangular U-shaped enclosure

Height	Width	Consisting of:	For ...	pure	Price
1400-2000	700-1200	1 swing door with fixed segment		513380	2.412,-
1400-2000	200-1200	2 side panels 1 extension kit for U-shaped enclosure			
1400-2000	700-1200	1 swing door with fixed segment		514480	2.412,-
1400-2000	200-1200	2 side panels 1 extension kit for U-shaped enclosure			
1400-2000	700-1200	1 swing door with fixed segment		513180	2.412,-
1400-2000	200-1200	1 short side panel			
1400-2000	200-1200	1 side panel 1 extension kit for U-shaped enclosure			
1400-2000	700-1200	1 swing door with fixed segment		513280	2.412,-
1400-2000	200-1200	1 short side panel			
1400-2000	200-1200	1 side panel 1 extension kit for U-shaped enclosure			
1400-2000	500-1250	1 folding swing door - Right-hand fixing		515280	2.842,-
1400-2000	700-1200	1 swing door with fixed segment			
1400-2000	200-1200	1 side panel 1 extension kit for U-shaped enclosure			
1400-2000	500-1250	1 folding swing door - Left-hand fixing		515380	2.842,-
1400-2000	700-1200	1 swing door with fixed segment			
1400-2000	200-1200	1 side panel 1 extension kit for U-shaped enclosure			

It must be stated whether the specified dimensions refer to the tray installation dimensions or the middle glass installation dimensions (e.g. floor-flush).
 The following therefore needs to be specified in the order with respect to dimensions:
 Refers to the tray installation dimensions: 000
 Refers to the middle glass installation dimensions: 001

Colours - Panel options

Profile colours	Colour code	Extra charges	Panel options		
			without Anti-Plaque Glass code	with Anti-Plaque Glass code	
White	055	0,-	321	322	
Matt silver	087		0,-	368	418,-
Black	023	312,-	341	378	
Grey/brown	061		371,-	316	789,-
Silver high-gloss	092		315		

HÜPPE 501 Design pure Rectangular

Swing door, rectangular U-shaped enclosure

Height	Width	Consisting of:	For ...	pure	Price
1400-2000	500-1250	1 folding swing door - Right-hand fixing		515480	2.842,-
1400-2000	700-1200	1 swing door with fixed segment			
1400-2000	200-1200	1 short side panel 1 extension kit for U-shaped enclosure			
1400-2000	500-1250	1 folding swing door - Left-hand fixing		515580	2.842,-
1400-2000	700-1200	1 swing door with fixed segment			
1400-2000	200-1200	1 short side panel 1 extension kit for U-shaped enclosure			
1400-2000	700-1200	1 swing door with fixed segment		515680	2.699,-
1400-2000	500-1100	1 swing door			
1400-2000	200-1200	1 side panel 1 extension kit for U-shaped enclosure			
1400-2000	700-1200	1 swing door with fixed segment		515780	2.699,-
1400-2000	500-1100	1 swing door			
1400-2000	200-1200	1 side panel 1 extension kit for U-shaped enclosure			
1400-2000	700-1200	1 swing door with fixed segment		515880	2.699,-
1400-2000	500-1100	1 swing door			
1400-2000	200-1200	1 short side panel 1 extension kit for U-shaped enclosure			
1400-2000	700-1200	1 swing door with fixed segment		515980	2.699,-
1400-2000	500-1100	1 swing door			
1400-2000	200-1200	1 short side panel 1 extension kit for U-shaped enclosure			

It must be stated whether the specified dimensions refer to the tray installation dimensions or the middle glass installation dimensions (e.g. floor-flush).

The following therefore needs to be specified in the order with respect to dimensions:

Refers to the tray installation dimensions: 000

Refers to the middle glass installation dimensions: 001

Colours - Panel options

Profile colours	Colour code	Extra charges	Panel options		without Anti-Plaque		with Anti-Plaque	
			Glass code	Extra charges	Glass code	Extra charges		
White	055	0,-	Clear	321	0,-	322	418,-	
Matt silver	087		Grey	301		368		
Black	023	312,-	Bronze	341	371,-	378	789,-	
Grey/brown	061		Sand Plus	315		316		
Silver high-gloss	092							

Two-way door, rectangular U-shaped enclosure

Height	Width	Consisting of:	For ...	pure	Price
1400-2000	600-1100	1 two-way door		513580	2.555,-
1400-2000	200-1200	2 side panels 1 extension kit for U-shaped enclosure			

1400-2000	600-1100	1 two-way door		514580	2.555,-
1400-2000	200-1200	1 short side panel			
1400-2000	200-1200	1 side panel 1 extension kit for U-shaped enclosure			

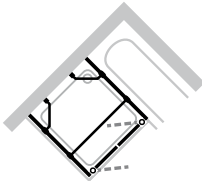
1400-2000	600-1100	1 two-way door		513480	2.555,-
1400-2000	200-1200	1 short side panel			
1400-2000	200-1200	1 side panel 1 extension kit for U-shaped enclosure			

It must be stated whether the specified dimensions refer to the tray installation dimensions or the middle glass installation dimensions (e.g. floor-flush).

The following therefore needs to be specified in the order with respect to dimensions:

Refers to the tray installation dimensions: 000

Refers to the middle glass installation dimensions: 001



Colours - Panel options

Profile colours	Colour code	Extra charges
White	055	
Matt silver	087	0,-
Black	023	
Grey/brown	061	312,-
Silver high-gloss	092	

Panel options	without Anti-Plaque		with Anti-Plaque	
	Glass code	Extra charges	Glass code	Extra charges
Clear	321	0,-	322	418,-
Grey	301		368	
Bronze	341		378	
Sand Plus	315	371,-	316	789,-
Privatima	373		375	
Bubbles	376		377	

HÜPPE 501 Design pure Quadrant

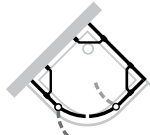
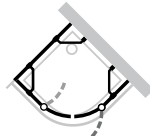
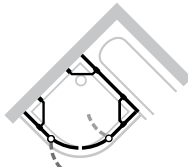
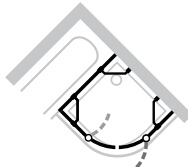
Swing door, quadrant U-shaped enclosure

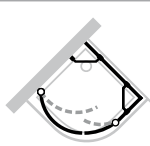
Height	Width	Consisting of:	For ...	pure	Price
1900/2000 1900/2000	750-1100 750-1100	1 quadrant swing door 1 side panel 1 extension kit for U-shaped enclosure		513780	2.755,-
1900/2000 1900/2000	750-1100 750-1100	1 quadrant swing door 1 side panel 1 extension kit for U-shaped enclosure		514780	2.755,-
1900/2000 1900/2000	750-1100 750-1100	1 quadrant swing door 1 short side panel 1 extension kit for U-shaped enclosure		514680	2.755,-
1900/2000 1900/2000	750-1100 750-1100	1 quadrant swing door 1 short side panel 1 extension kit for U-shaped enclosure		513680	2.755,-
1900/2000 1900/2000 1400-2000	735-1135 800/900/1000 (R500/R550) 200-1200	1 Quadrant swing door with fixed segment 1 swing door 1 side panel 1 extension kit for U-shaped enclosure		516080	2.637,-
1900/2000 1900/2000 1400-2000	735-1135 800/900/1000 (R500/R550) 200-1200	1 Quadrant swing door with fixed segment 1 swing door 1 side panel 1 extension kit for U-shaped enclosure		516180	2.637,-
It must be stated whether the specified dimensions refer to the tray installation dimensions or the middle glass installation dimensions (e.g. floor-flush).					
The following therefore needs to be specified in the order with respect to dimensions:					
Refers to the tray installation dimensions: 000					
Refers to the middle glass installation dimensions: 001					

Colours - Panel options

Profile colours	Colour code	Extra charges
White	055	0,-
Matt silver	087	
Black	023	312,-
Grey/brown	061	
Silver high-gloss	092	

Panel options	without Anti-Plaque		with Anti-Plaque	
	Glass code	Extra charges	Glass code	Extra charges
Clear	321	0,-	322	418,-
Sand Plus	315	371,-	316	789,-

Swing door, quadrant U-shaped enclosure

Height	Width	Consisting of:	For ...	pure	Price
1900/2000	735-1135	1 Quadrant swing door with fixed segment		516280	2.637,-
1900/2000	800/900/1000 (R500/R550)	1 swing door			
1400-2000	200-1200	1 short side panel 1 extension kit for U-shaped enclosure			

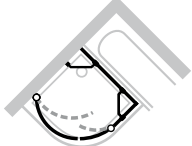
1900/2000	735-1135	1 Quadrant swing door with fixed segment		516380	2.637,-
1900/2000	800/900/1000 (R500/R550)	1 swing door			
1400-2000	200-1200	1 short side panel 1 extension kit for U-shaped enclosure			

It must be stated whether the specified dimensions refer to the tray installation dimensions or the middle glass installation dimensions (e.g. floor-flush).

The following therefore needs to be specified in the order with respect to dimensions:

Refers to the tray installation dimensions: 000



Refers to the middle glass installation dimensions: 001

Colours - Panel options

Profile colours	Colour code	Extra charges	Panel options		without Anti-Plaque		with Anti-Plaque	
			Glass code	Extra charges	Glass code	Extra charges		
White	055	0,-	Clear	321	0,-	322	418,-	
Matt silver	087		Sand Plus	315	371,-	316	789,-	
Black	023	312,-						
Grey/brown	061							
Silver high-gloss	092							

HÜPPE 501 Design pure Pentagonal

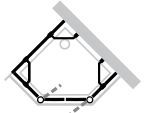
Swing door, pentagonal U-shaped enclosure

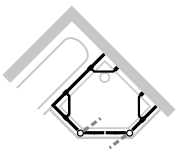
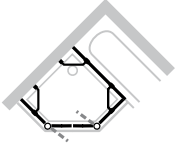
Height	Width	Consisting of:	For ...	pure	Price
1400-2000	785-1000 785-1000	1 pentagonal swing door with fixed segments 1 side panel, left 1 extension kit for U-shaped enclosure		513980	2.757,-
1400-2000	785-1000 785-1000	1 pentagonal swing door with fixed segments 1 side panel, right 1 extension kit for U-shaped enclosure		514980	2.757,-
1400-2000 to 2000	785-1000 785-1000	1 pentagonal swing door with fixed segments 1 short side panel 1 extension kit for U-shaped enclosure		513880	2.757,-
1400-2000 to 2000	785-1000 785-1000	1 pentagonal unit 1 short side panel 1 extension kit for U-shaped enclosure		514880	2.757,-

It must be stated whether the specified dimensions refer to the tray installation dimensions or the middle glass installation dimensions (e.g. floor-flush).

The following therefore needs to be specified in the order with respect to dimensions:

Refers to the tray installation dimensions: 000

Refers to the middle glass installation dimensions: 001

Colours - Panel options

Profile colours	Colour code	Extra charges	Panel options	without Anti-Plaque		with Anti-Plaque	
				Glass code	Extra charges	Glass code	Extra charges
White	055	0,-	Clear	321	0,-	322	418,-
Matt silver	087		Grey	301		368	
Black	023	312,-	Bronze	341	371,-	378	789,-
Grey/brown	061		Sand Plus	315		316	
Silver high-gloss	092						

HÜPPE Enjoy elegance frameless

HÜPPE Enjoy pure frameless



HÜPPE Enjoy elegance frameless model overview - Base price

HÜPPE Enjoy pure frameless model overview - Base price

Rectangular

Swing door corner entry with fixed segments

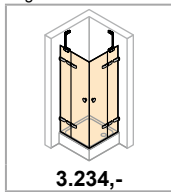

3.234,-

I.4-I.5

Swing door with fixed segment in recess

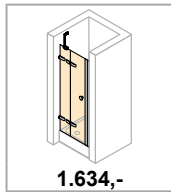

1.634,-

I.6-I.7

Swing door with fixed segment and side panel

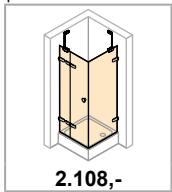

2.108,-

I.8-I.9

Swing door in recess

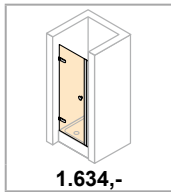

1.634,-

I.10-I.11

Swing door with side panel

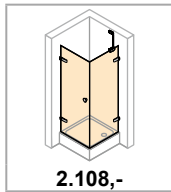

2.108,-

I.12-I.13

Swing door with additional section in recess

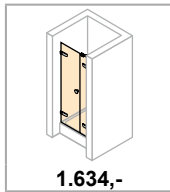

1.634,-

I.14-I.15

Quadrant

Swing door with fixed segments, 2-panel

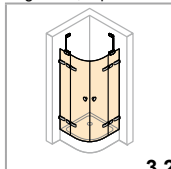

I.16-I.17

Swing door with fixed segments, 1-panel

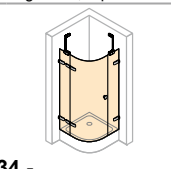

3.234,-

I.18-I.19

Pentagonal

Swing door with fixed segments, 1-panel

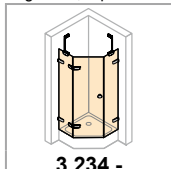

3.234,-

I.20-I.21

Walk-In

Free standing side panel

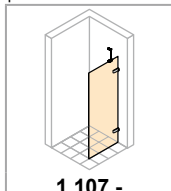

1.107,-

S.8-S.9

Walk-In side panel with movable segment

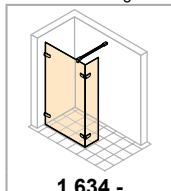

1.634,-

S.10-S.11

Enjoy elegance
Enjoy pure
frameless

HÜPPE Enjoy elegance frameless

HÜPPE Enjoy pure frameless

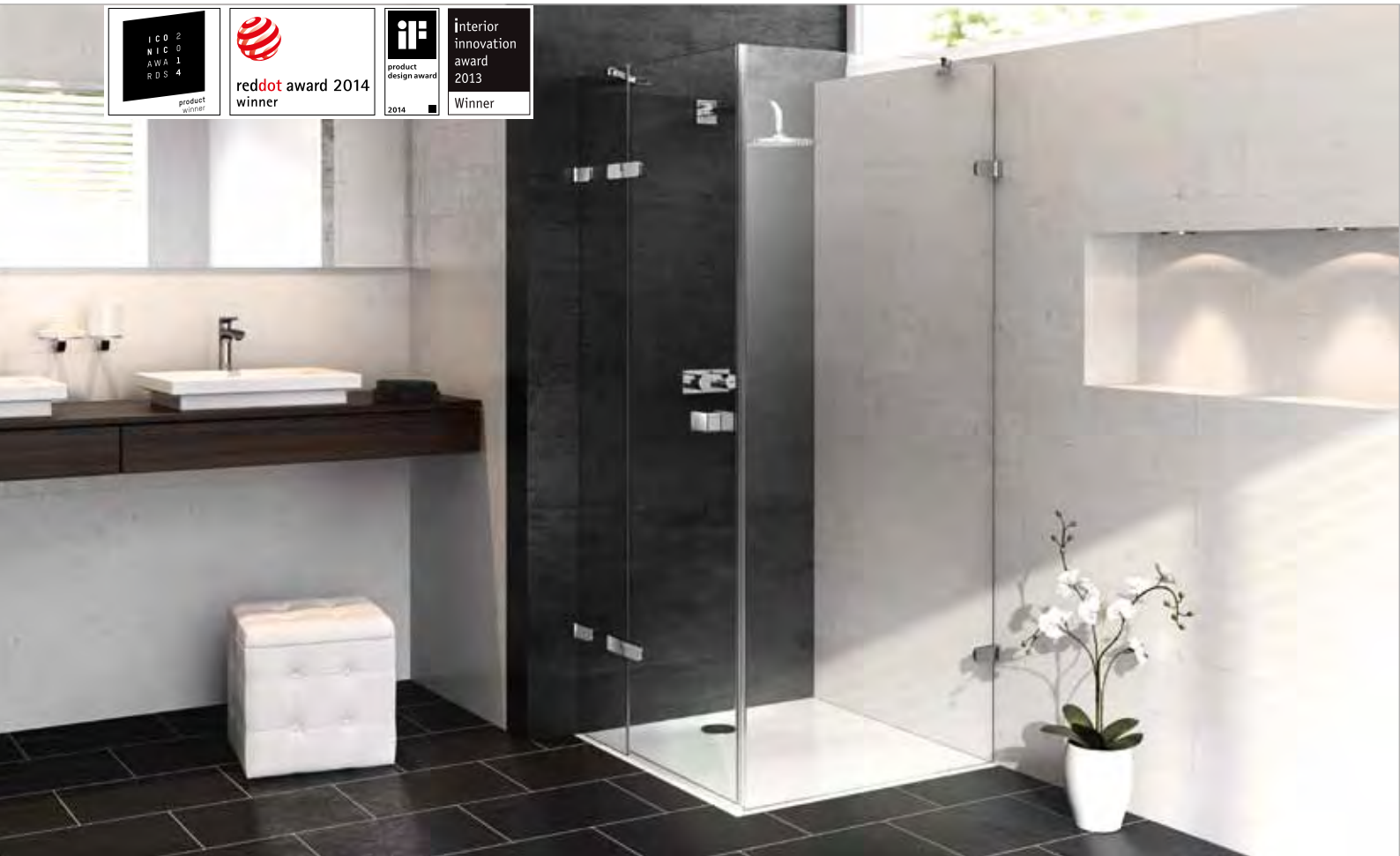
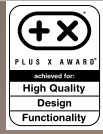

Product details



Hinge HÜPPE Enjoy elegance



Handle HÜPPE Enjoy elegance



Handle HÜPPE Enjoy elegance



Inner flush hinges
(Photo: HÜPPE Enjoy elegance)



Handle HÜPPE Enjoy elegance
Special options 800



Hinge HÜPPE Enjoy pure



Handle HÜPPE Enjoy pure



Handle HÜPPE Enjoy pure



All models of the HÜPPE Enjoy series can be optionally installed with a drip deflector strip for optimum tightness or as easy access units

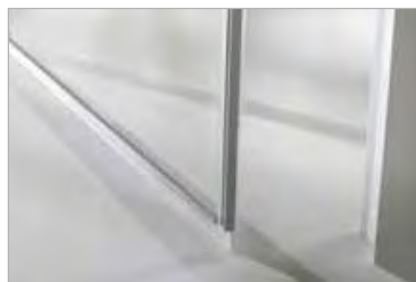

Handle HÜPPE Enjoy pure
Special options 800

HÜPPE Enjoy elegance frameless Rectangular

HÜPPE Enjoy pure frameless Rectangular

elegance



pure

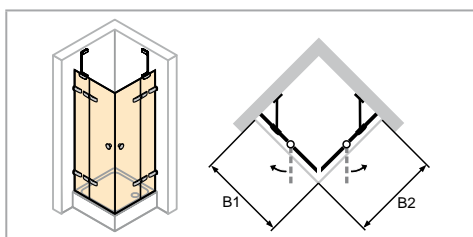

- Measurements must always be taken.
- Mirror glass (380/381): Please state in your order which segment should be produced with mirror glass. If this is not stated, the entire unit will be produced with mirror glass.
- For technical information, see Profile Colours and Panel Options section.

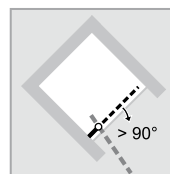
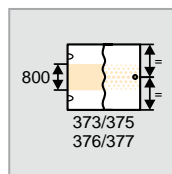
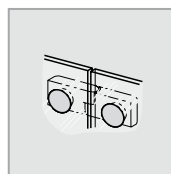
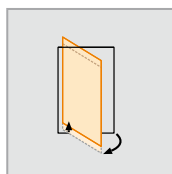
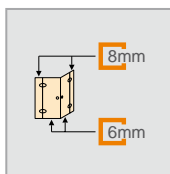

Swing door corner entry with fixed segments





Made-to-measure

Height	Width B1	Width B2	elegance	pure	Base price
1600-2000	700-1200	700-1200	3R0180	4R0180	3.234,-
	1201-1500	1201-1500	3R0181	4R0181	4.021,-

Slopes and cut-outs

Slopes and cut-outs	Extra charges
	Supplement per slope/cut-out for made-to-measure 170,-

Dim. Range: min. - max.

			
1600-2000	700-1500	210-600	max. 900

Special options

Optional variants	Extra charges
Comfort handle	800 114,-

Colours - Panel options

Profile colours	Colour code	Extra charges	Panel options		without Anti-Plaque		with Anti-Plaque	
			Glass code	Extra charges	Glass code	Extra charges		
Silver high-gloss	092	0,-	Clear	321	0,-	322	418,-	
			Sand Plus	315		316		
			Privatima	373	371,-	375	789,-	
			Bubbles	376		377		
			Mirror glass	380	439,-	381	857,-	

HÜPPE Enjoy elegance frameless Rectangular

HÜPPE Enjoy pure frameless Rectangular

elegance

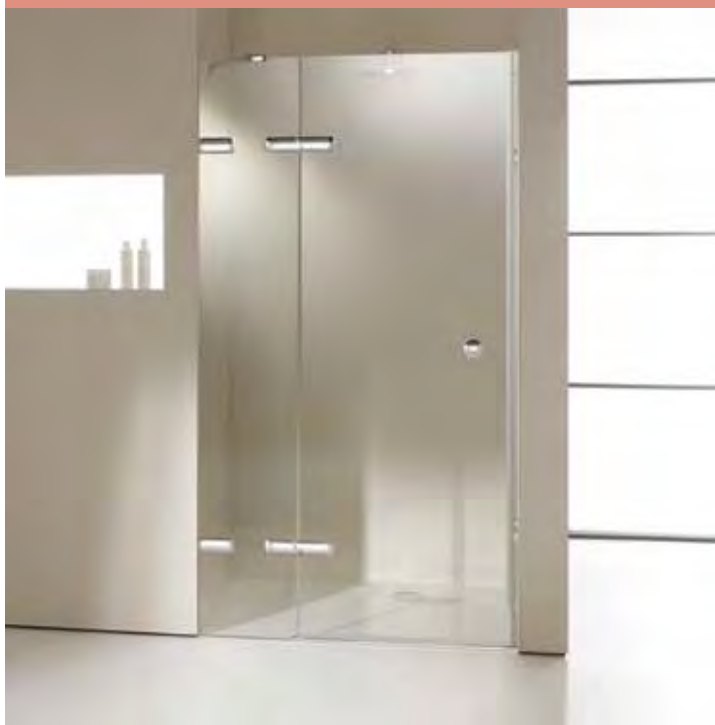

pure

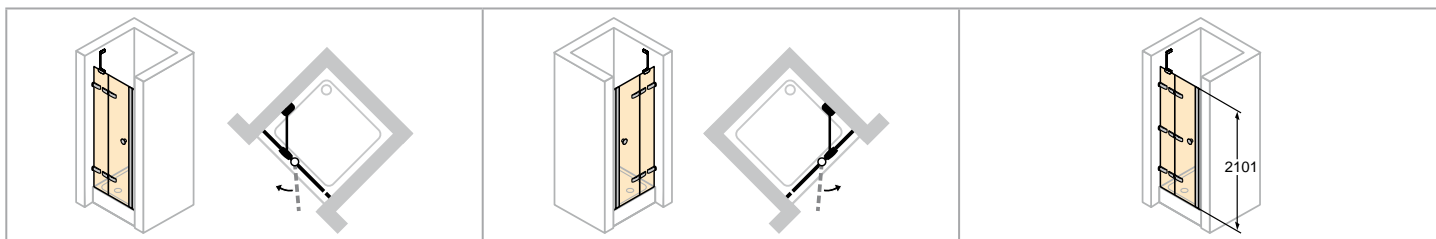

Left-hand fixing

Right-hand fixing

- Measurements must always be taken.
- Mirror glass (380/381): Please state in your order which segment should be produced with mirror glass. If this is not stated, the entire unit will be produced with mirror glass.
- For technical information, see Profile Colours and Panel Options section.

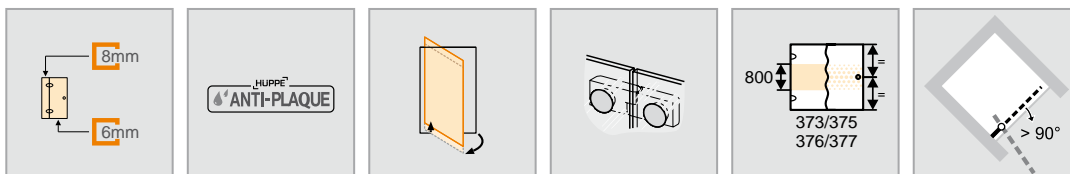

Swing door with fixed segment in recess

Made-to-measure - Left-hand fixing

Height	Width of door front	elegance	pure	Base price
1600-2000	700-1200	3R0980	4R0980	1.634,-
	1201-1500	3R0981	4R0981	2.027,-
2001-2400	700-1200	3R0982	4R0982	1.809,-
	1201-1500	3R0983	4R0983	2.203,-





Made-to-measure - Right-hand fixing

Height	Width of door front	elegance	pure	Base price
1600-2000	700-1200	3R1080	4R1080	1.634,-
	1201-1500	3R1081	4R1081	2.027,-
2001-2400	700-1200	3R1082	4R1082	1.809,-
	1201-1500	3R1083	4R1083	2.203,-

Slopes and cut-outs

Slopes and cut-outs	Extra charges
	Supplement per slope/cut-out for made-to-measure 170,-

Dim. Range: min. - max.

			
1600-2400	700-1500	210-600	max. 900

Special options

Optional variants	Extra charges
Comfort handle	800 57,-

Colours - Panel options

Profile colours	Colour code	Extra charges	Panel options	without Anti-Plaque		with Anti-Plaque	
				Glass code	Extra charges	Glass code	Extra charges
Silver high-gloss	092	0,-	Clear	321	0,-	322	209,-
			Sand Plus	315		316	
			Privatima	373	186,-	375	395,-
			Bubbles	376		377	
			Mirror glass	380	439,-	381	648,-

HÜPPE Enjoy elegance frameless Rectangular

HÜPPE Enjoy pure frameless Rectangular

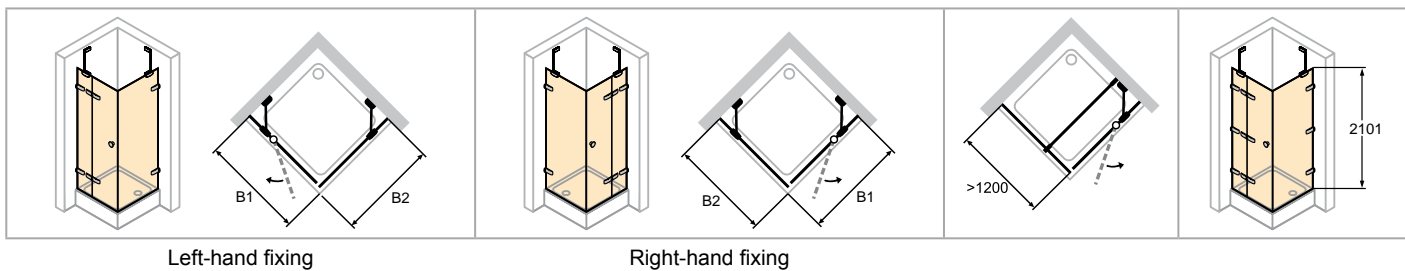
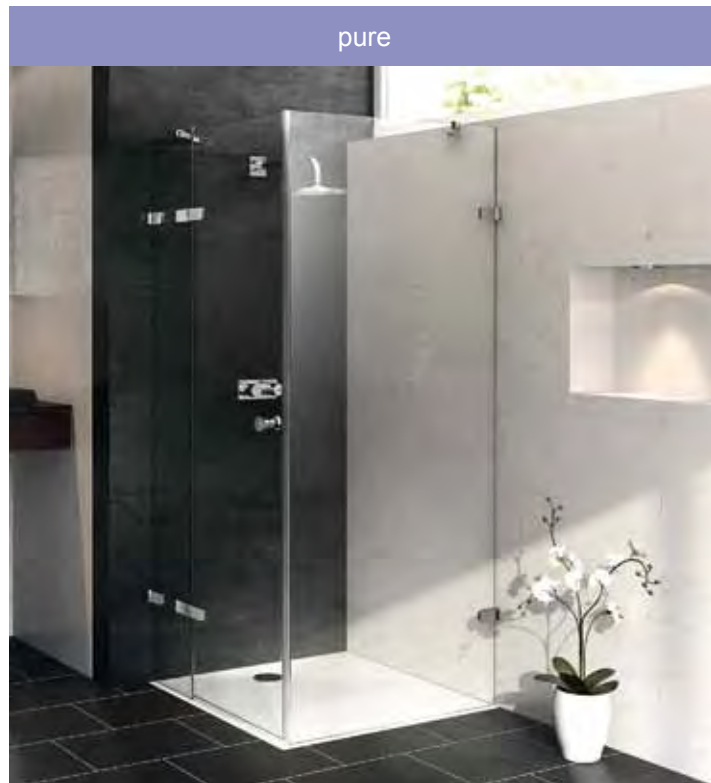

- Measurements must always be taken.
- Mirror glass (380/381): Please state in your order which segment should be produced with mirror glass. If this is not stated, the entire unit will be produced with mirror glass.
- For technical information, see Profile Colours and Panel Options section.
- Towel rail height can be selected individually and must be specified with the order. If nothing is specified, the towel rail is always delivered middle of glass (height and width).
- Installation of towel rail only possible on side panel.



Swing door with fixed segment and side panel

Made-to-measure - Left-hand fixing

Height	Door width B1	Width Side panel B2	elegance	pure	Base price
1600-2000	700-1200	300-1200	3R0580	4R0580	2.108,-
	700-1200	1201-1600	3R0581	4R0581	2.502,-
	1201-1500	300-1200			
2001-2400	1201-1500	1201-1600	3R0582	4R0582	2.896,-
	700-1200	300-1200	3R0583	4R0583	2.460,-
	700-1200	1201-1600	3R0584	4R0584	2.853,-
	1201-1500	300-1200			
	1201-1500	1201-1600	3R0585	4R0585	3.246,-

Made-to-measure - Right-hand fixing

Height	Door width B1	Width Side panel B2	elegance	pure	Base price
1600-2000	700-1200	300-1200	3R0680	4R0680	2.108,-
	700-1200	1201-1600	3R0681	4R0681	2.502,-
	1201-1500	300-1200			
2001-2400	1201-1500	1201-1600	3R0682	4R0682	2.896,-
	700-1200	300-1200	3R0683	4R0683	2.460,-
	700-1200	1201-1600	3R0684	4R0684	2.853,-
	1201-1500	300-1200			
	1201-1500	1201-1600	3R0685	4R0685	3.246,-

Slopes and cut-outs

Slopes and cut-outs	Extra charges
	Supplement per slope/cut-out for made-to-measure 170,-

Dim. Range: min. - max.

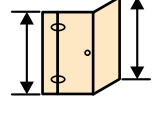
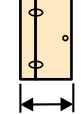
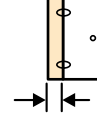
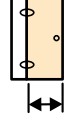
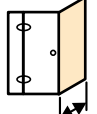
				
1600-2400	700-1500	210-600	max. 900	300-1600

Special options

Optional variants	Extra charges
Comfort handle	800 57,-
Towel rail (silver high-gloss)	T99 210,-
Towel rail and comfort handle	T00 267,-

Colours - Panel options

Profile colours	Colour code	Extra charges	Panel options	without Anti-Plaque		with Anti-Plaque	
				Glass code	Extra charges	Glass code	Extra charges
Silver high-gloss	092	0,-	Clear	321	0,-	322	418,-
			Sand Plus	315		316	
			Privatima	373	371,-	375	789,-
			Bubbles	376		377	
			Mirror glass	380	439,-	381	857,-

HÜPPE Enjoy elegance frameless Rectangular
HÜPPE Enjoy pure frameless Rectangular

elegance



pure

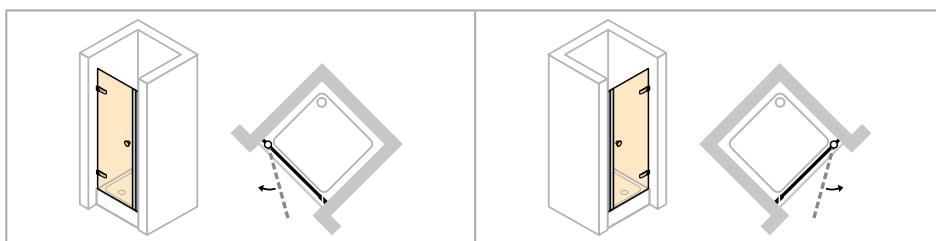
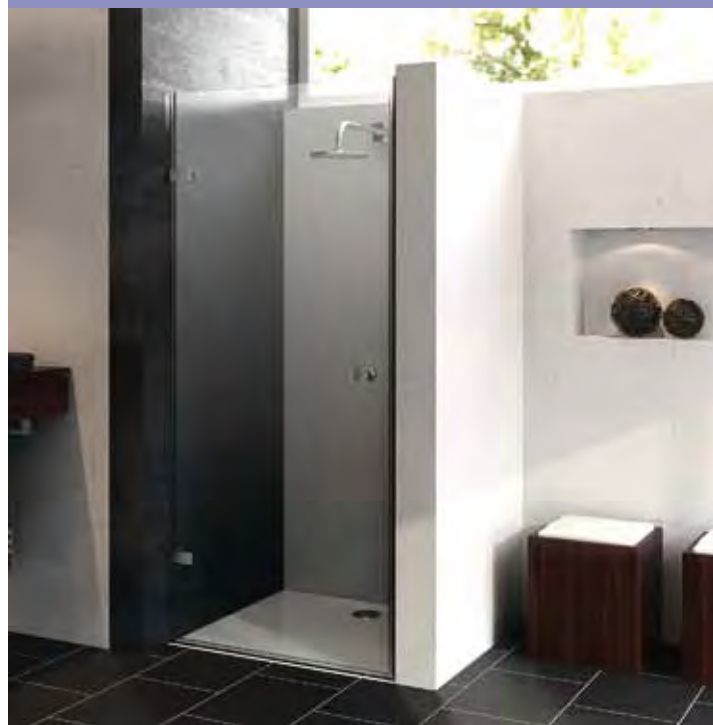

Left-hand fixing

Right-hand fixing

▪ Measurements must always be taken.

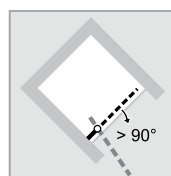
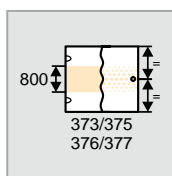
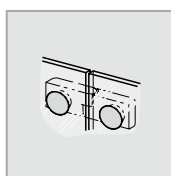
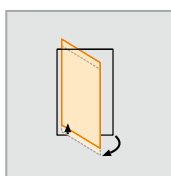
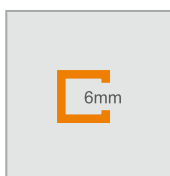

Swing door in recess

Made-to-measure - Left-hand fixing

Height	Width of door front	elegance	pure	Base price
1600-2000	500-1000	3R0780	4R0780	1.634,-



Made-to-measure - Right-hand fixing

Height	Width of door front	elegance	pure	Base price
1600-2000	500-1000	3R0880	4R0880	1.634,-

Slopes and cut-outs

Slopes and cut-outs	Extra charges
	Supplement per slope/cut-out for made-to-measure 170,-

Dim. Range: min. - max.

	
1600-2000	500-1000

Special options

Optional variants	Extra charges
Comfort handle	800 57,-

Colours - Panel options

Profile colours	Colour code	Extra charges	Panel options	without Anti-Plaque		with Anti-Plaque	
				Glass code	Extra charges	Glass code	Extra charges
Silver high-gloss	092	0,-	Clear	321	0,-	322	209,-
			Sand Plus	315		316	
			Privatima	373	186,-	375	395,-
			Bubbles	376		377	
			Mirror glass	380	439,-	381	648,-

HÜPPE Enjoy elegance frameless Rectangular

HÜPPE Enjoy pure frameless Rectangular

elegance



pure

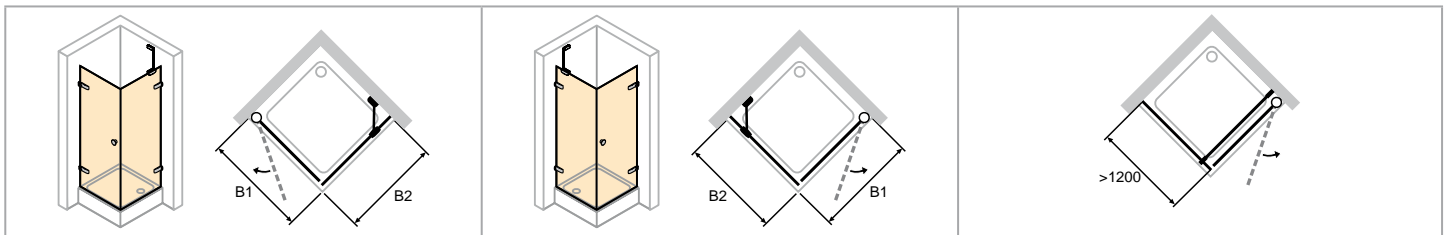

Left-hand fixing

Right-hand fixing

- Measurements must always be taken.
- Mirror glass (380/381): Please state in your order which segment should be produced with mirror glass. If this is not stated, the entire unit will be produced with mirror glass.
- For technical information, see Profile Colours and Panel Options section.
- Towel rail height can be selected individually and must be specified with the order. If nothing is specified, the towel rail is always delivered middle of glass (height and width).
- Installation of towel rail only possible on side panel.

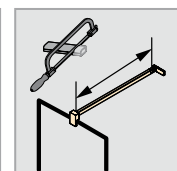
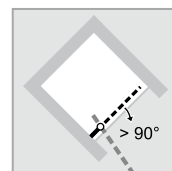
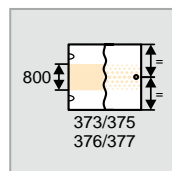
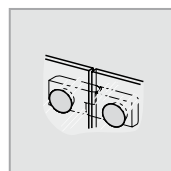
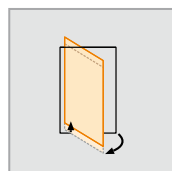
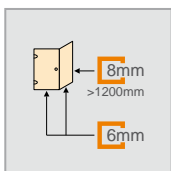

HÜPPE Enjoy elegance frameless Rectangular

HÜPPE Enjoy pure frameless Rectangular

Swing door with side panel

Made-to-measure - Left-hand fixing

Height	Door width B1	Width Side panel B2	elegance	pure	Base price
1600-2000	500-1000	300-1200	3R0380	4R0380	2.108,-
	500-1000	1201-1600	3R0381	4R0381	2.502,-

Made-to-measure - Right-hand fixing

Height	Door width B1	Width Side panel B2	elegance	pure	Base price
1600-2000	500-1000	300-1200	3R0480	4R0480	2.108,-
	500-1000	1201-1600	3R0482	4R0482	2.502,-

Slopes and cut-outs

Slopes and cut-outs	Extra charges
	Supplement per slope/cut-out for made-to-measure 170,-

Dim. Range: min. - max.

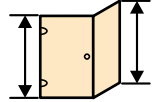
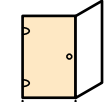
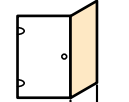
		
1600-2000	500-1000	300-1600

Special options

Optional variants	Extra charges
Comfort handle	800 57,-
Towel rail (silver high-gloss)	T99 210,-
Towel rail and comfort handle	T00 267,-

Colours - Panel options

Profile colours	Colour code	Extra charges	Panel options		without Anti-Plaque		with Anti-Plaque	
			Glass code	Extra charges	Glass code	Extra charges		
Silver high-gloss	092	0,-	Clear	321	0,-	322	418,-	
			Sand Plus	315		316		
			Privatima	373	371,-	375	789,-	
			Bubbles	376		377		
			Mirror glass	380	439,-	381	857,-	

HÜPPE Enjoy elegance frameless Rectangular

HÜPPE Enjoy pure frameless Rectangular

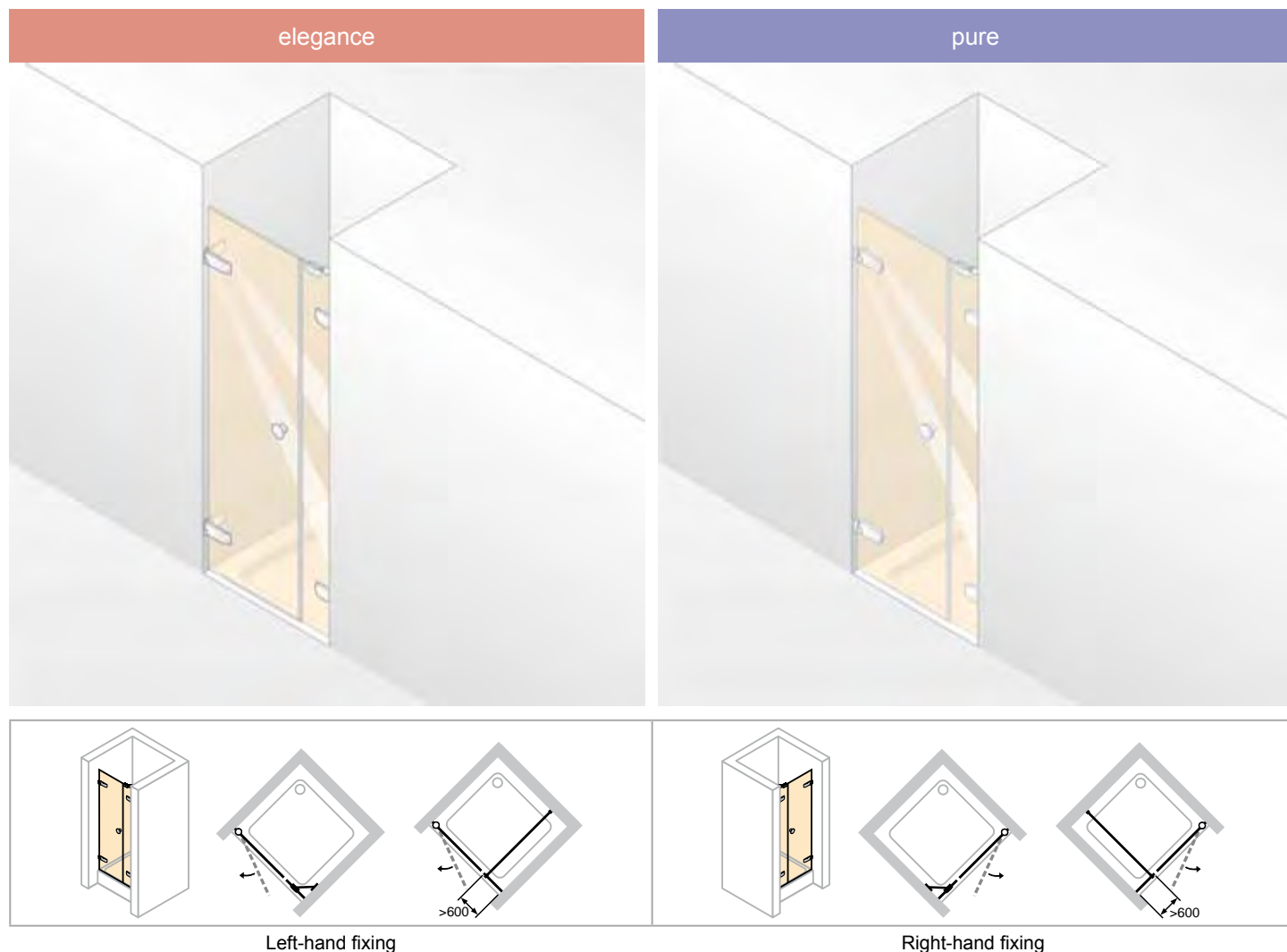

- Measurements must always be taken.
- Mirror glass (380/381): Please state in your order which segment should be produced with mirror glass. If this is not stated, the entire unit will be produced with mirror glass.
- For technical information, see Profile Colours and Panel Options section.

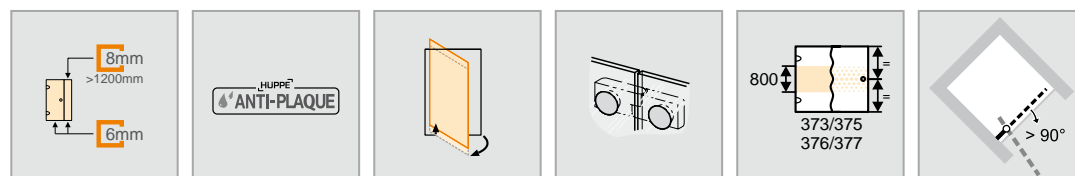

Swing door with additional section in recess

Made-to-measure - Left-hand fixing

Height	Width of door front	elegance	pure	Base price
1600-2000	700-1200	3R1680	4R1680	1.634,-
	1201-2600	3R1681	4R1681	2.027,-





Made-to-measure - Right-hand fixing

Height	Width of door front	elegance	pure	Base price
1600-2000	700-1200	3R1780	4R1780	1.634,-
	1201-2600	3R1781	4R1781	2.027,-

Slopes and cut-outs

Slopes and cut-outs	Extra charges
	Supplement per slope/cut-out for made-to-measure 170,-

Dim. Range: min. - max.

			
1600-2000	700-2600	max. 1000	200-1800

Special options

Optional variants	Extra charges
Comfort handle	800 57,-

Colours - Panel options

Profile colours	Colour code	Extra charges	Panel options	without Anti-Plaque		with Anti-Plaque	
				Glass code	Extra charges	Glass code	Extra charges
Silver high-gloss	092	0,-	Clear	321	0,-	322	209,-
			Sand Plus	315		316	
			Privatima	373	186,-	375	395,-
			Bubbles	376		377	
			Mirror glass	380	439,-	381	648,-

HÜPPE Enjoy elegance frameless Quadrant

HÜPPE Enjoy pure frameless Quadrant

elegance



pure

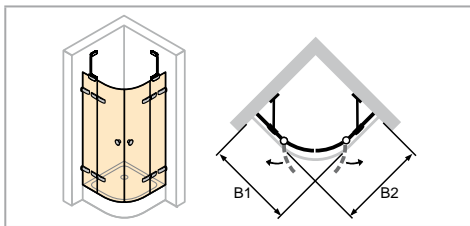

▪ Measurements must always be taken.

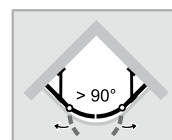
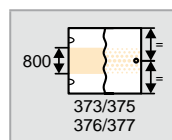
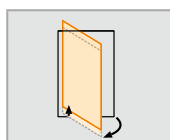
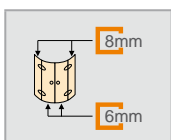

Swing door with fixed segments, 2-panel

Made-to-measure

Height	Width B1	Width B2	Entry width	Radius	elegance	pure	Base price
2000	900-1200	900-1200	810	500	3R1580	4R1580	3.234,-
	900-1200	900-1200	880	550	3R1581	4R1581	

Slopes and cut-outs

Slopes and cut-outs	Extra charges
	Supplement per slope/cut-out for made-to-measure 170,-

Dim. Range: min. - max.

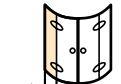
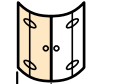
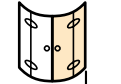
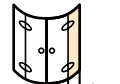
				
2000	210-600	900-1200	900-1200	210-600

Special options

Optional variants	Extra charges
Comfort handle	800 114,-

Colours - Panel options

Profile colours	Colour code	Extra charges	Panel options		without Anti-Plaque		with Anti-Plaque	
			Glass code	Extra charges	Glass code	Extra charges		
Silver high-gloss	092	0,-	Clear	321	0,-	322	418,-	
			Sand Plus	315		316		
			Privatima	373	371,-	375	789,-	
			Bubbles	376		377		

HÜPPE Enjoy elegance frameless Quadrant

HÜPPE Enjoy pure frameless Quadrant

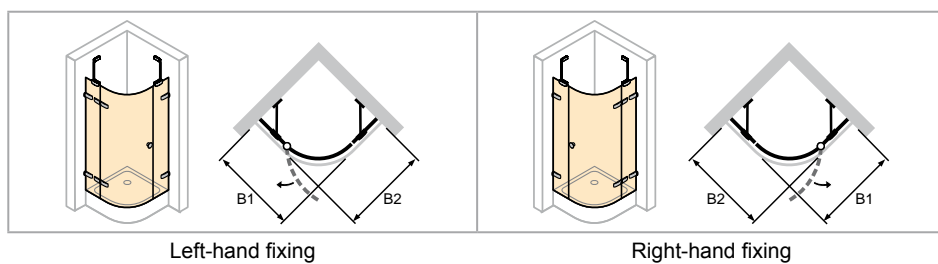
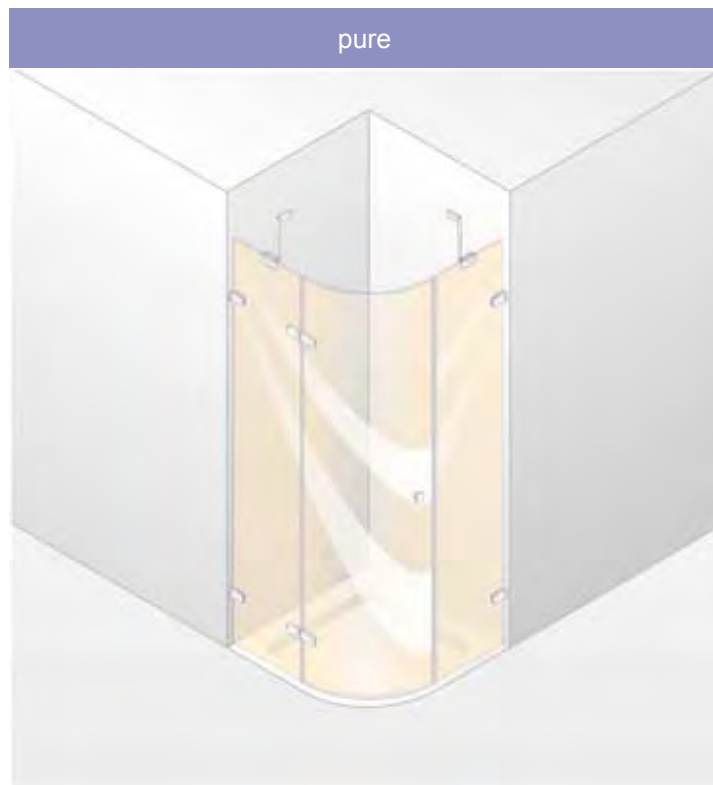
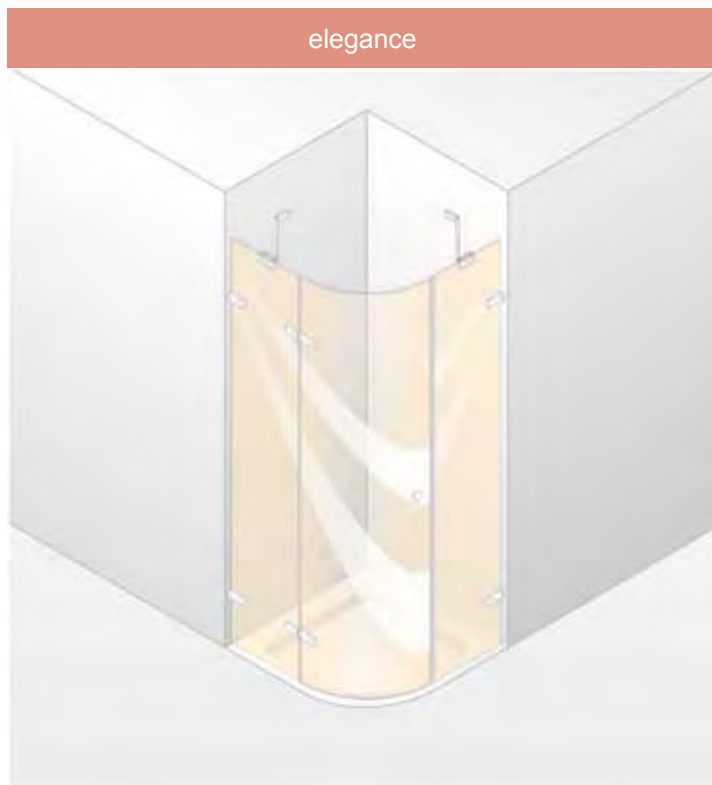

- Measurements must always be taken.

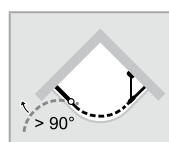
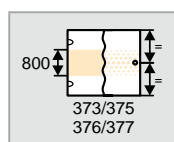
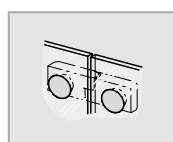
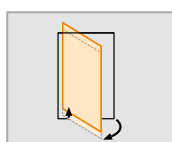
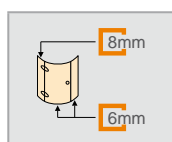

Swing door with fixed segments, 1-panel

Made-to-measure - Left-hand fixing

Height	Width B1	Width B2	Entry width	Radius	elegance	pure	Base price
2000	900-1200	900-1200	742	500	3R1880	4R1880	3.234,-
	900-1200	900-1200	800	550	3R1881	4R1881	



Made-to-measure - Right-hand fixing

Height	Width B1	Width B2	Entry width	Radius	elegance	pure	Base price
2000	900-1200	900-1200	742	500	3R1980	4R1980	3.234,-
	900-1200	900-1200	800	550	3R1981	4R1981	

Slopes and cut-outs

Slopes and cut-outs	Extra charges
	Supplement per slope/cut-out for made-to-measure 170,-

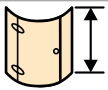
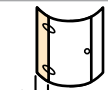
Dim. Range: min. - max.

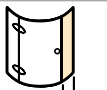
				
2000	210-600	900-1200	900-1200	200-1800

Special options

Optional variants	Extra charges
Comfort handle	800 57,-

Colours - Panel options

Profile colours	Colour code	Extra charges	Panel options		without Anti-Plaque		with Anti-Plaque	
			Glass code	Extra charges	Glass code	Extra charges		
Silver high-gloss	092	0,-	Clear	321	0,-	322	418,-	
			Sand Plus	315		316		
			Privatima	373	371,-	375	789,-	
			Bubbles	376		377		

HÜPPE Enjoy elegance frameless Pentagonal

HÜPPE Enjoy pure frameless Pentagonal

elegance



pure

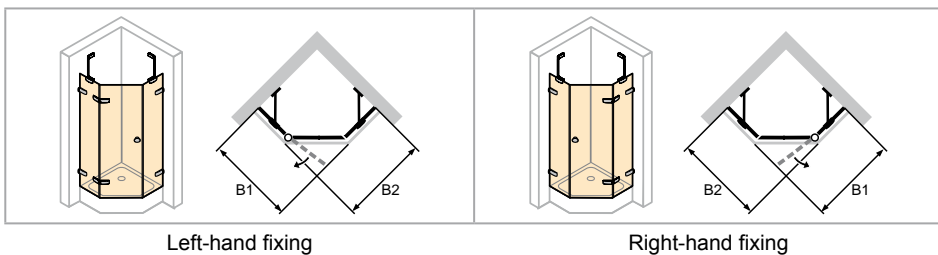

• Measurements must always be taken.



Swing door with fixed segments, 1-panel

Made-to-measure - Left-hand fixing

Height	Width B1	Width B2	elegance	pure	Base price
1600-2000	720-1100	720-1100	3R2080	4R2080	3.234,-



Made-to-measure - Right-hand fixing

Height	Width B1	Width B2	elegance	pure	Base price
1600-2000	720-1100	720-1100	3R2180	4R2180	3.234,-

Slopes and cut-outs

Slopes and cut-outs	Extra charges
	Supplement per slope/cut-out for made-to-measure 170,-

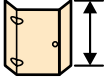
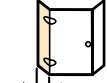
Dim. Range: min. - max.

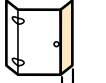
				
1600-2000	210-600	720-1100	720-1100	200-1800

Special options

Optional variants	Extra charges
Comfort handle	800 57,-

Colours - Panel options

Profile colours	Colour code	Extra charges	Panel options		without Anti-Plaque		with Anti-Plaque	
			Glass code	Extra charges	Glass code	Extra charges		
Silver high-gloss	092	0,-	Clear	321	0,-	322	418,-	
			Sand Plus	315		316		
			Privatima	373	371,-	375	789,-	
			Bubbles	376		377		

HÜPPE Enjoy elegance partially framed

HÜPPE Enjoy pure partially framed

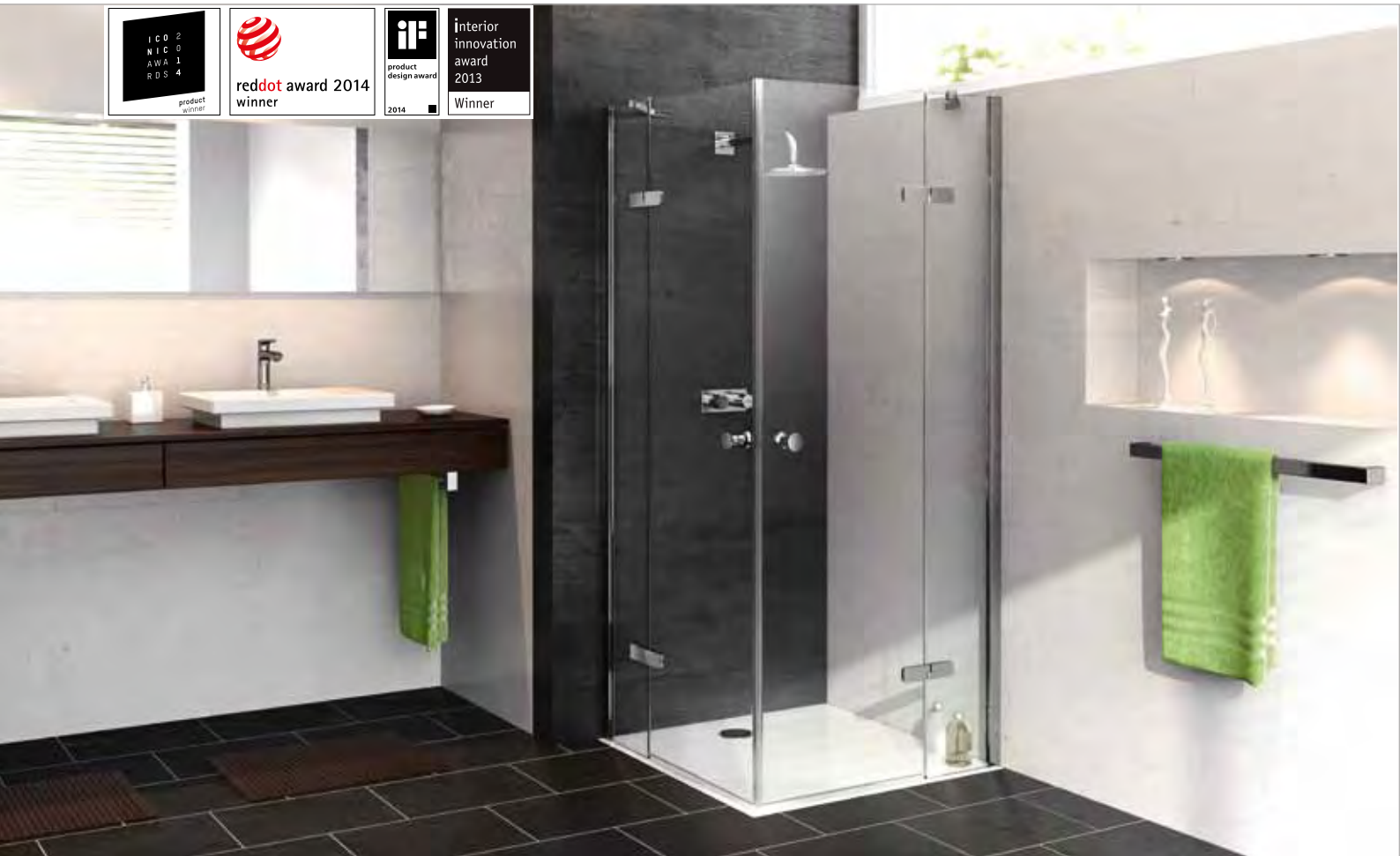

HÜPPE Enjoy elegance partially framed model overview - Base price

HÜPPE Enjoy pure partially framed model overview - Base price

Rectangular

Swing door corner entry with fixed segments

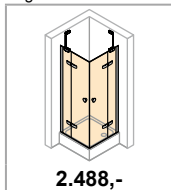

2.488,-

J.4-J.5

Swing door with fixed segment in recess

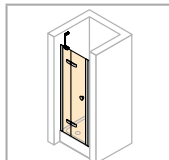

1.257,-

J.6-J.7

Swing door with fixed segment for side panel/corner entry

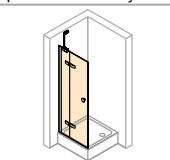

J.8-J.11

Side panel for swing door with fixed segment

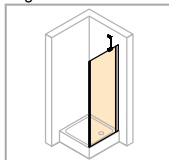

851,-

J.12-J.13

Swing door in recess

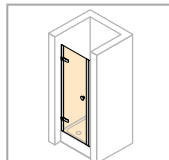

J.14-J.15

Swing door for side panel

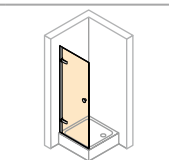

1.257,-

J.16-J.17

Side panel for swing door

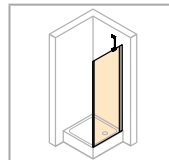

851,-

J.18-J.19

Swing door with additional section in recess

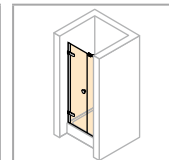

1.257,-

J.20-J.21

Two-way door in recess

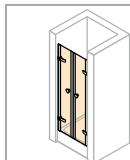

1.656,-

J.22-J.23

Two-way door for side panel

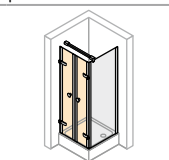

J.24-J.25

Side panel for two-way door

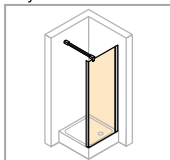

851,-

J.26-J.29

Quadrant

Swing door with fixed segments, 1-panel

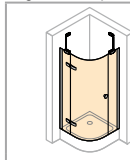

J.30-J.33

Swing door with fixed segments, 2-panel

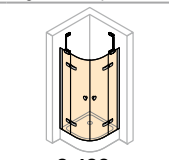

2.488,-

J.34-J.35

Swing door with fixed segments, 1-panel

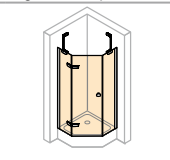

J.36-J.37

Pentagonal

Walk-In

Free standing side panel

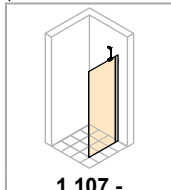

1.107,-

S.12-S.13

Walk-In side panel with movable segment

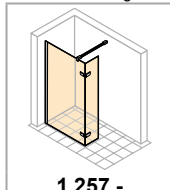

1.257,-

S.14-S.15

Enjoy elegance
Enjoy pure
partially framed

HÜPPE Enjoy elegance partially framed

HÜPPE Enjoy pure partially framed

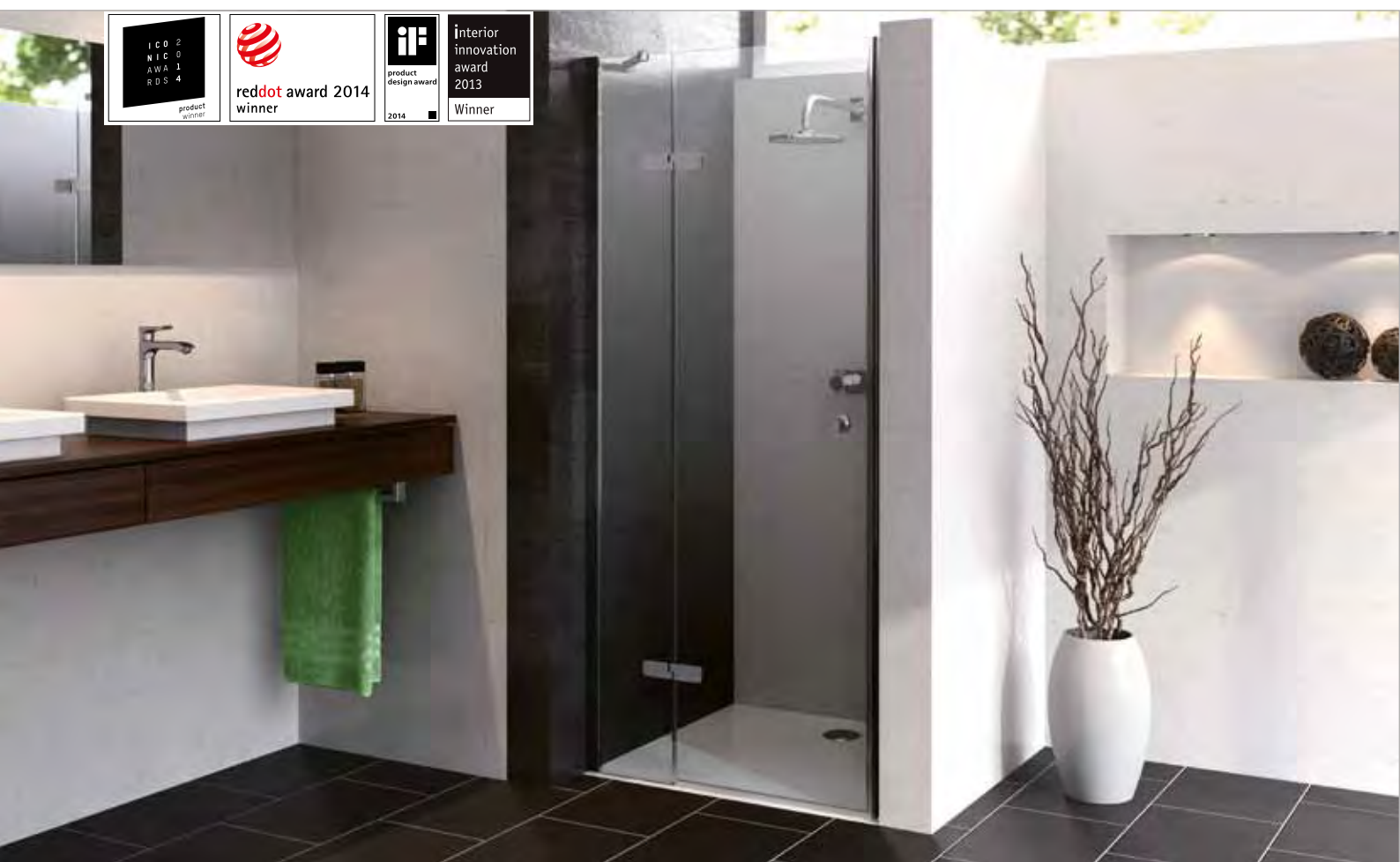

Product details



Hinge HÜPPE Enjoy elegance



HÜPPE Enjoy elegance wall profile with Keder system



Handle HÜPPE Enjoy elegance



Inner flush hinges
(Photo: HÜPPE Enjoy elegance)



Handle HÜPPE Enjoy elegance
Special options 800



Hinge HÜPPE Enjoy pure

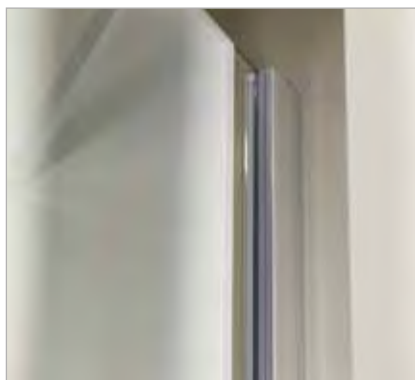

HÜPPE Enjoy pure wall profile with Keder system



Handle HÜPPE Enjoy pure



All models of the HÜPPE Enjoy series can be optionally installed with a drip deflector strip for optimum tightness or as easy access units

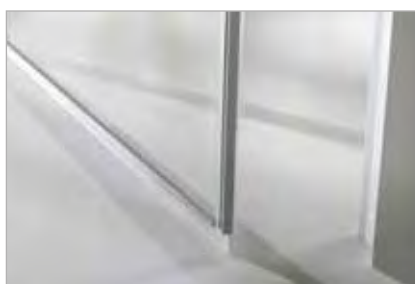

Handle HÜPPE Enjoy pure
Special options 800

HÜPPE Enjoy elegance partially framed Rectangular

HÜPPE Enjoy pure partially framed Rectangular

elegance



pure

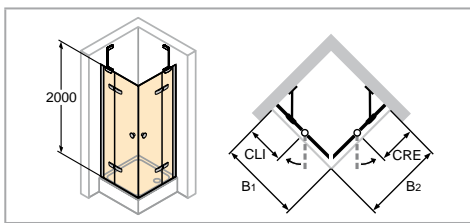
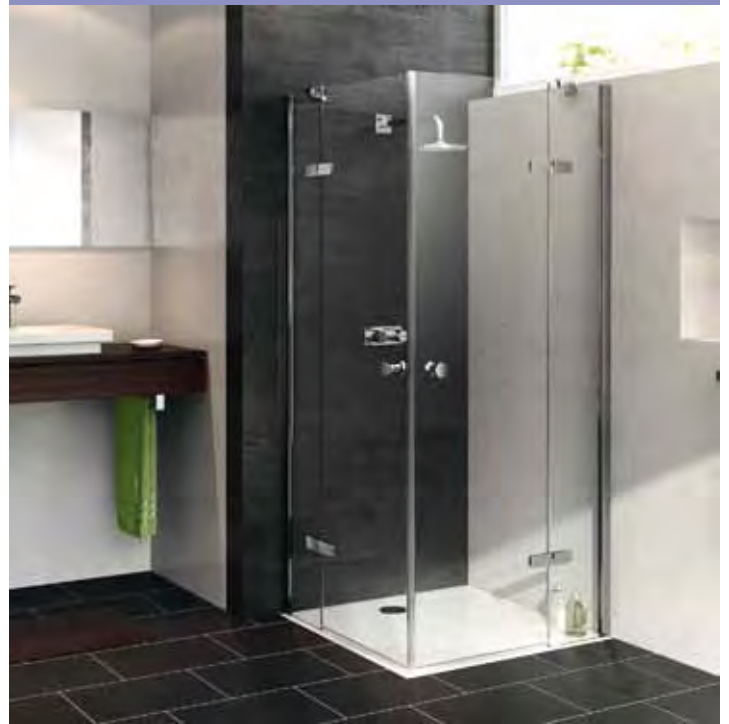

- Mirror glass (380/381): Please state in your order which segment should be produced with mirror glass. If this is not stated, the entire unit will be produced with mirror glass.
- For technical information, see Profile Colours and Panel Options section.

Dimensions

WL: 26
R: 20
Mx: M+12
MG: 32

WEM = Tray installation dim. (000)
M = installation dimension Centre glass (001)
Please always specify when ordering.

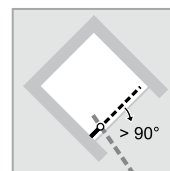
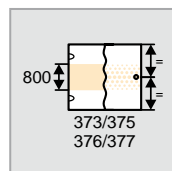
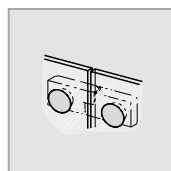
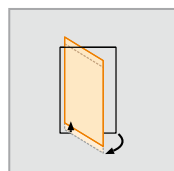
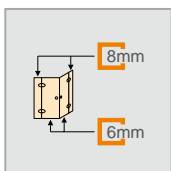

Swing door corner entry with fixed segments

Installation on shower tray recommended

Height	Model B1/B2	WEM B1	WEM B2	M (middle of glass) B1	M (middle of glass) B2	CLI/CRE	Entry width	elegance	pure	Base price
2000	800x800	785-805	785-805	753-773	753-773	265-285	673	3T3301	4T3301	2.488,-
	900x900	885-905	885-905	853-873	853-873	265-285	814	3T3302	4T3302	
	1000x1000	985-1005	985-1005	953-973	953-973	365-385	814	3T3303	4T3303	2.588,-

Floor-flush installation recommended

Height	Model B1/B2	M (middle of glass) B1	M (middle of glass) B2	CLI/CRE	Entry width	elegance	pure	Base price
2000	800x800	790-810	790-810	297-317	673	3T3304	4T3304	2.488,-
	900x900	890-910	890-910	297-317	814	3T3305	4T3305	
	1000x1000	990-1010	990-1010	397-417	814	3T3306	4T3306	2.588,-

Made-to-measure

Height	Width B1/B2	elegance	pure	Base price
1600-2000	700-1200	3T3380	4T3380	3.234,-
	1201-1500	3T3381	4T3381	4.021,-





Adjustment range = dimensions - 10mm / + 10mm

With made-to-measure the width for the fixed panel must be specified.

Slopes and cut-outs

Slopes and cut-outs	Extra charges
 Supplement per slope/cut-out for made-to-measure	170,-

Dim. Range: min. - max.

			
1600-2000	700-1500	210-600	max. 900

Special options

Optional variants	Extra charges
Comfort handle	800

Colours - Panel options

Profile colours	Colour code	Extra charges	Panel options	without Anti-Plaque		with Anti-Plaque	
				Glass code	Extra charges	Glass code	Extra charges
White	055	0,-	Clear	321	0,-	322	418,-
Matt silver	087		Sand Plus	315		316	
Silver high-gloss	092		Privatima	373	371,-	375	789,-
			Bubbles	376		377	
			Mirror glass	380	439,-	381	857,-

HÜPPE Enjoy elegance partially framed Rectangular

HÜPPE Enjoy pure partially framed Rectangular

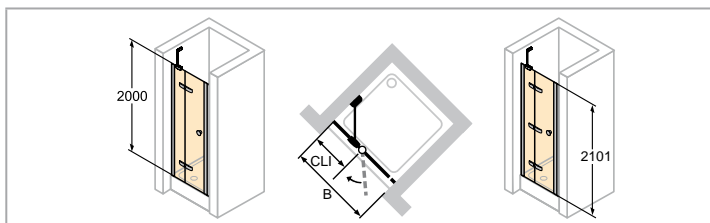
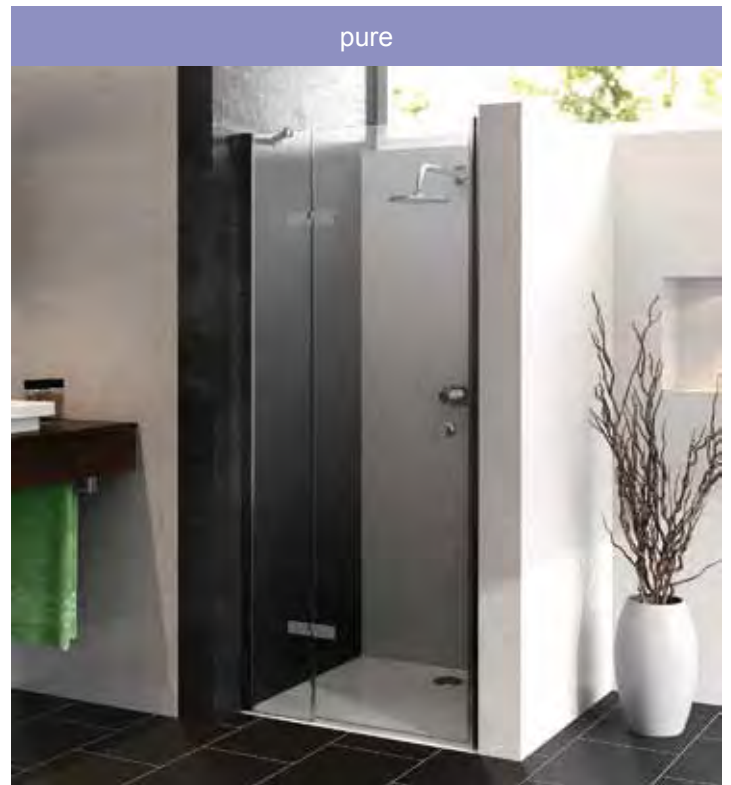

Left-hand fixing

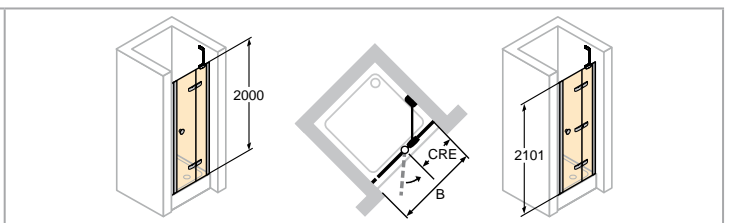

Right-hand fixing

- Mirror glass (380/381): Please state in your order which segment should be produced with mirror glass. If this is not stated, the entire unit will be produced with mirror glass.
- For technical information, see Profile Colours and Panel Options section.

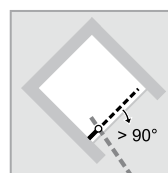
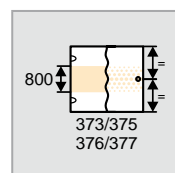
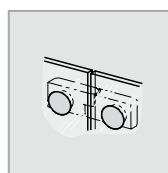
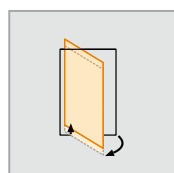
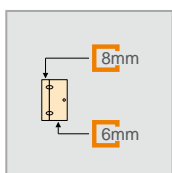
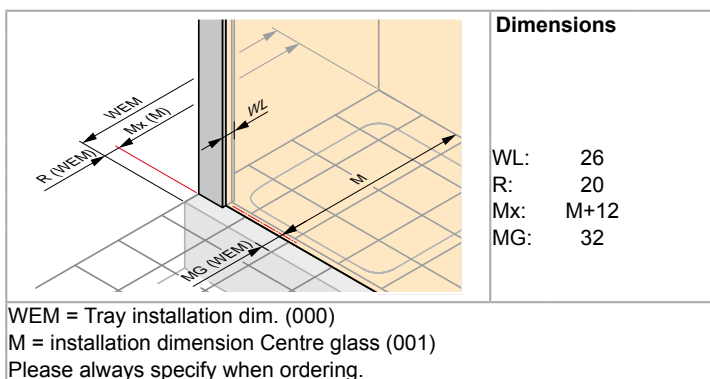

Swing door with fixed segment in recess

Left-hand fixing

Height	Model	WEM B	M (middle of glass) B	CLI	Entry width	elegance	pure	Base price
2000	800	780-810	780-810	265-285	464	3T0901	4T0901	1.257,-
	900	880-910	880-910	265-285	564	3T0902	4T0902	
	1000	980-1010	980-1010	365-385	564	3T0903	4T0903	1.310,-
	1200	1180-1210	1180-1210	465-485	664	3T0904	4T0904	1.333,-

Made-to-measure - Left-hand fixing

Height	Width B	elegance	pure	Base price
1600-2000	700-1200	3T0980	4T0980	1.634,-
	1201-1500	3T0985	4T0985	2.027,-
2001-2200	700-1200	3T0986	4T0986	1.809,-
	1201-1500	3T0987	4T0987	2.203,-

Adjustment range = dimensions - 20mm / + 10mm

With made-to-measure the width for the fixed panel must be specified.

Right-hand fixing

Height	Model	WEM B	M (middle of glass) B	CRE	Entry width	elegance	pure	Base price
2000	800	780-810	780-810	265-285	464	3T1001	4T1001	1.257,-
	900	880-910	880-910	265-285	564	3T1002	4T1002	
	1000	980-1010	980-1010	365-385	564	3T1003	4T1003	1.310,-
	1200	1180-1210	1180-1210	465-485	664	3T1004	4T1004	1.333,-

Made-to-measure - Right-hand fixing

Height	Width B	elegance	pure	Base price
1600-2000	700-1200	3T1080	4T1080	1.634,-
	1201-1500	3T1085	4T1085	2.027,-
2001-2200	700-1200	3T1086	4T1086	1.809,-
	1201-1500	3T1087	4T1087	2.203,-

Adjustment range = dimensions - 20mm / + 10mm

With made-to-measure the width for the fixed panel must be specified.

Slopes and cut-outs

Slopes and cut-outs	Extra charges
	Supplement per slope/cut-out for made-to-measure 170,-

Dim. Range: min. - max.

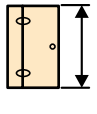
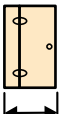
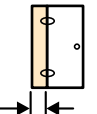
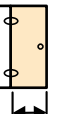
			
1600-2200	700-1500	210-600	max. 900

Special options

Optional variants	Extra charges
Comfort handle	800 57,-

Colours - Panel options

Profile colours	Colour code	Extra charges	Panel options	without Anti-Plaque		with Anti-Plaque	
				Glass code	Extra charges	Glass code	Extra charges
White	055	0,- 156,-	Clear	321	0,-	322	209,-
Matt silver	087		Sand Plus	315		316	
Silver high-gloss	092		Privatima	373	186,-	375	395,-
			Bubbles	376		377	
			Mirror glass	380	439,-	381	648,-

HÜPPE Enjoy elegance partially framed Rectangular

HÜPPE Enjoy pure partially framed Rectangular

elegance



pure

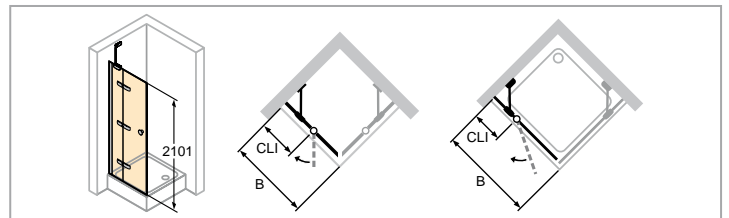
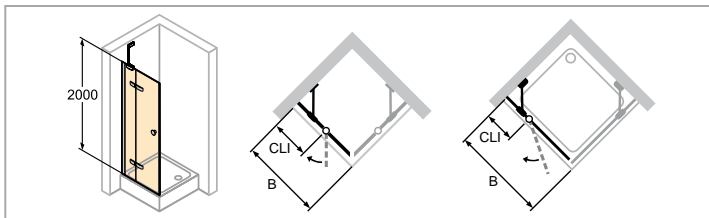

- Mirror glass (380/381): Please state in your order which segment should be produced with mirror glass. If this is not stated, the entire unit will be produced with mirror glass.
- Shortened side panel can only be combined with door in recess.
- For technical information, see Profile Colours and Panel Options section.

Dimensions	
	<p>WL: 26</p> <p>R: 20</p> <p>Mx: M+12</p> <p>MG: 32</p>
<p>WEM = Tray installation dim. (000)</p> <p>M = installation dimension Centre glass (001)</p> <p>Please always specify when ordering.</p>	

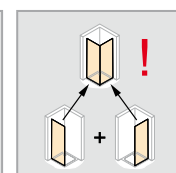
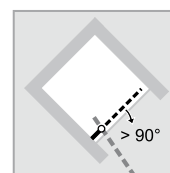
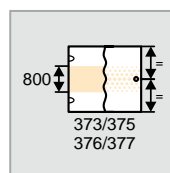
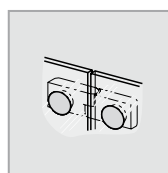
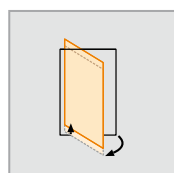
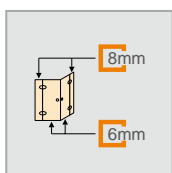

HÜPPE Enjoy elegance partially framed Rectangular

HÜPPE Enjoy pure partially framed Rectangular

Swing door with fixed segment for side panel/corner entry

Left-hand fixing

Installation on shower tray recommended

Height	Model	WEM B	M (middle of glass) B	CLI	Entry width STS	elegance	pure	Base price
2000	750	735-755	703-723	215-235	450	3T0101	4T0101	1.257,-
	800	785-805	753-773	265-285	480	3T0102	4T0102	
	900	885-905	853-873	265-285	580	3T0103	4T0103	1.310,-
	1000	985-1005	953-973	365-385	580	3T0104	4T0104	
	1200	1185-1205	1153-1173	465-485	680	3T0105	4T0105	

NOTE: The complete corner entry consists of two item nos.

Left-hand fixing

Floor-flush installation recommended

Height	Model	M (middle of glass) B	CLI	Entry width STS	elegance	pure	Base price
2000	750	740-760	247-267	450	3T0106	4T0106	1.257,-
	800	790-810	297-317	480	3T0107	4T0107	
	900	890-910	297-317	580	3T0108	4T0108	1.310,-
	1000	990-1010	397-417	580	3T0109	4T0109	
	1200	1190-1210	497-517	680	3T0110	4T0110	

Made-to-measure - Left-hand fixing

Height	Width B	elegance	pure	Base price
1600-2000	700-1200	3T0180	4T0180	1.634,-
	1201-1500	3T0181	4T0181	2.027,-
2001-2200	700-1200	3T0182	4T0182	1.809,-
	1201-1500	3T0183	4T0183	2.203,-





Adjustment range = dimensions - 10mm / + 10mm

With made-to-measure the width for the fixed panel must be specified.

Slopes and cut-outs

Slopes and cut-outs	Extra charges
 Supplement per slope/cut-out for made-to-measure	170,-

Dim. Range: min. - max.

			
1600-2200	700-1500	210-600	max. 900

Special options

Optional variants	Extra charges
Comfort handle	800
	57,-

Colours - Panel options

Profile colours	Colour code	Extra charges	Panel options	without Anti-Plaque		with Anti-Plaque	
				Glass code	Extra charges	Glass code	Extra charges
White	055	0,-	Clear	321	0,-	322	209,-
Matt silver	087		Sand Plus	315		316	
Silver high-gloss	092		Privatima	373	186,-	375	395,-
			Bubbles	376		377	
			Mirror glass	380	439,-	381	648,-

HÜPPE Enjoy elegance partially framed Rectangular

HÜPPE Enjoy pure partially framed Rectangular

elegance



pure

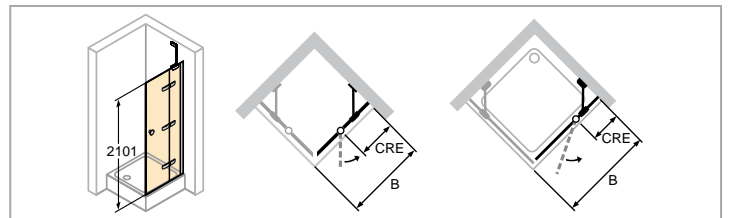
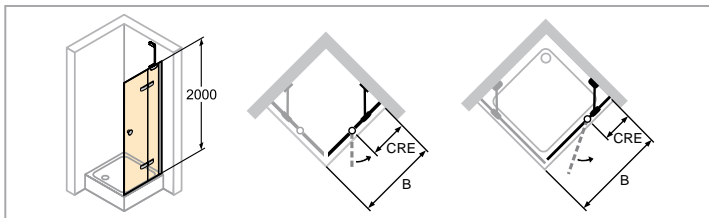

- Mirror glass (380/381): Please state in your order which segment should be produced with mirror glass. If this is not stated, the entire unit will be produced with mirror glass.
- Shortened side panel can only be combined with door in recess.
- For technical information, see Profile Colours and Panel Options section.

Dimensions	
	<p>WL: 26</p> <p>R: 20</p> <p>Mx: M+12</p> <p>MG: 32</p>
<p>WEM = Tray installation dim. (000)</p> <p>M = installation dimension Centre glass (001)</p> <p>Please always specify when ordering.</p>	

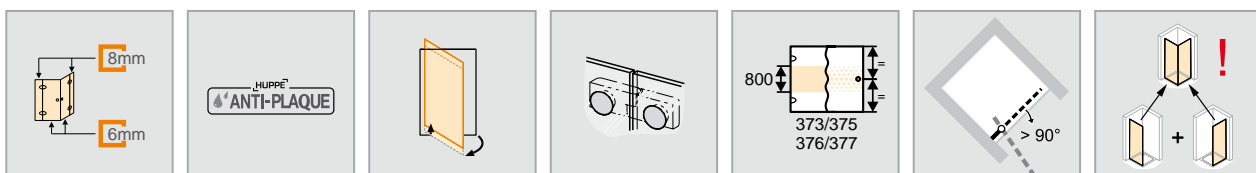

HÜPPE Enjoy elegance partially framed Rectangular

HÜPPE Enjoy pure partially framed Rectangular

Swing door with fixed segment for side panel/corner entry

Right-hand fixing

Installation on shower tray recommended

Height	Model	WEM B	M (middle of glass) B	CRE	Entry width STS	elegance	pure	Base price
2000	750	735-755	703-723	215-235	450	3T0201	4T0201	1.257,-
	800	785-805	753-773	265-285	480	3T0202	4T0202	
	900	885-905	853-873	265-285	580	3T0203	4T0203	1.310,-
	1000	985-1005	953-973	365-385	580	3T0204	4T0204	
	1200	1185-1205	1153-1173	465-485	680	3T0205	4T0205	

NOTE: The complete corner entry consists of two item nos.

Right-hand fixing

Floor-flush installation recommended

Height	Model	M (middle of glass) B	CRE	Entry width STS	elegance	pure	Base price
2000	750	740-760	247-267	450	3T0206	4T0206	1.257,-
	800	790-810	297-317	480	3T0207	4T0207	
	900	890-910	297-317	580	3T0208	4T0208	1.310,-
	1000	990-1010	397-417	580	3T0209	4T0209	
	1200	1190-1210	497-517	680	3T0210	4T0210	

Made-to-measure - Right-hand fixing

Height	Width B	elegance	pure	Base price
1600-2000	700-1200	3T0280	4T0280	1.634,-
	1201-1500	3T0281	4T0281	2.027,-
2001-2200	700-1200	3T0282	4T0282	1.809,-
	1201-1500	3T0283	4T0283	2.203,-





Adjustment range = dimensions - 10mm / + 10mm

With made-to-measure the width for the fixed panel must be specified.

Slopes and cut-outs

Slopes and cut-outs	Extra charges
 Supplement per slope/cut-out for made-to-measure	170,-

Dim. Range: min. - max.

			
1600-2200	700-1500	210-600	max. 900

Special options

Optional variants	Extra charges
Comfort handle	800
	57,-

Colours - Panel options

Profile colours	Colour code	Extra charges	Panel options	without Anti-Plaque		with Anti-Plaque	
				Glass code	Extra charges	Glass code	Extra charges
White	055	0,-	Clear	321	0,-	322	209,-
Matt silver	087		Sand Plus	315		316	
Silver high-gloss	092		Privatima	373	186,-	375	395,-
			Bubbles	376		377	
			Mirror glass	380	439,-	381	648,-

HÜPPE Enjoy elegance partially framed Rectangular

HÜPPE Enjoy pure partially framed Rectangular

elegance



pure

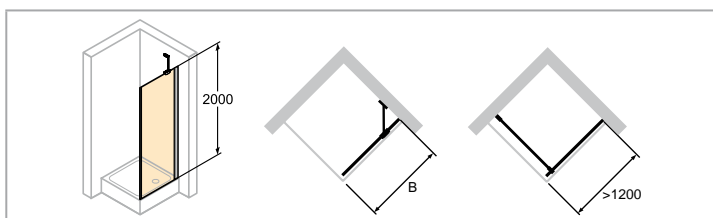

- Shortened side panel can only be combined with door in recess.
- Towel rail height can be selected individually and must be specified with the order. If nothing is specified, the towel rail is always delivered middle of glass (height and width).

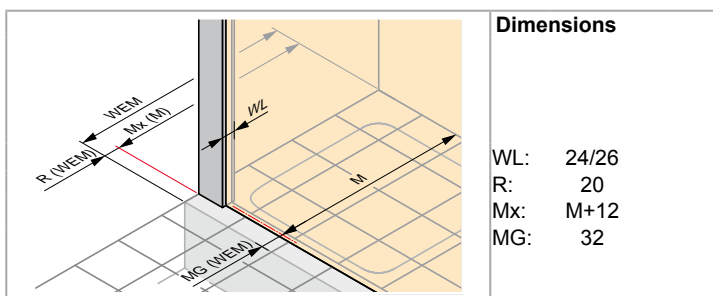

WEM = Tray installation dim. (000)
M = installation dimension Centre glass (001)
Please always specify when ordering.

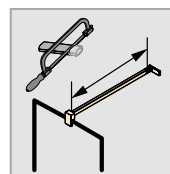
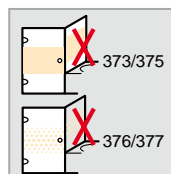
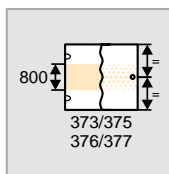
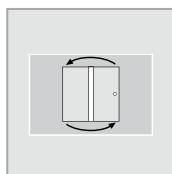
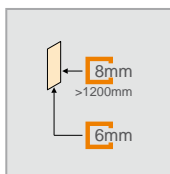

Side panel for swing door with fixed segment

Installation on shower tray recommended

Height	Model	WEM B	M (middle of glass) B	elegance	pure	Base price
2000	SW 700	685-705	653-673	3T1601	4T1601	851,-
	SW 750	735-755	703-723	3T1602	4T1602	
	SW 800	785-805	753-773	3T1603	4T1603	
	SW 900	885-905	853-873	3T1604	4T1604	887,-
	SW 1000	985-1005	953-973	3T1605	4T1605	
	SW 1200	1185-1205	1153-1173	3T1606	4T1606	
1750	SWK 700	685-705	653-673	3T1607	4T1607	851,-
	SWK 750	735-755	703-723	3T1608	4T1608	
	SWK 800	785-805	753-773	3T1609	4T1609	
	SWK 900	885-905	853-873	3T1610	4T1610	887,-
	SWK 1000	985-1005	953-973	3T1611	4T1611	

Floor-flush installation recommended

Height	Model	M (middle of glass) B	elegance	pure	Base price
2000	SW 750	740-760	3T1612	4T1612	851,-
	SW 800	790-810	3T1613	4T1613	
	SW 900	890-910	3T1614	4T1614	887,-
	SW 1000	990-1010	3T1615	4T1615	
	SW 1200	1190-1210	3T1616	4T1616	

Made-to-measure

Height	Model	Width B	Fixing	elegance	pure	Base price
1600-2000	Standard made-to-measure	200-1200	Stabilizer	3T1680	4T1680	1.106,-
	Standard made-to-measure	1201-1600	Cross bar	3T168E	4T168E	1.500,-
2001-2200	Standard made-to-measure	200-1200	Stabilizer	3T168F	4T168F	1.282,-
	Standard made-to-measure	1201-1600	Cross bar	3T168G	4T168G	1.676,-
1600-2000	In-line; only for swing door with fixed segment	200-1200 > 600	Stabilizer Cross bar	3T168I	4T168I	1.106,-
	In-line; only for swing door with fixed segment	1201-1600	Cross bar	3T168H	4T168H	1.500,-
2001-2200	In-line; only for swing door with fixed segment	200-1200 > 600	Stabilizer Cross bar	3T168J	4T168J	1.282,-
	In-line; only for swing door with fixed segment	1201-1600	Cross bar	3T168K	4T168K	1.676,-
400-2000	Corner configuration on bathtub; only with swing door with fixed segment in recess for recess.	200-1200	Stabilizer	3T1682	4T1682	1.106,-
2001-2200	Corner configuration on bathtub; only with swing door with fixed segment in recess for recess.	200-1200	Stabilizer	3T168M	4T168M	1.282,-



Adjustment range = dimensions - 10mm / + 10mm

Non-standard widths not possible for bathtub.

Slopes and cut-outs

Slopes and cut-outs	Extra charges
 Supplement per slope/cut-out for made-to-measure	170,-

Dim. Range: min. - max.

	
400-2200	200-1600

Special options

Special options	Extra charges
Towel rail (silver high-gloss)	T99 210,-

Colours - Panel options

Profile colours	Colour code	Extra charges	Panel options	without Anti-Plaque		with Anti-Plaque	
				Glass code	Extra charges	Glass code	Extra charges
White	055	0,-	Clear	321	0,-	322	209,-
Matt silver	087		Sand Plus	315		316	
Silver high-gloss	092		Privatima	373	186,-	375	395,-
			Bubbles	376		377	
			Mirror glass	380	439,-	381	648,-

HÜPPE Enjoy elegance partially framed Rectangular
HÜPPE Enjoy pure partially framed Rectangular

elegance



pure

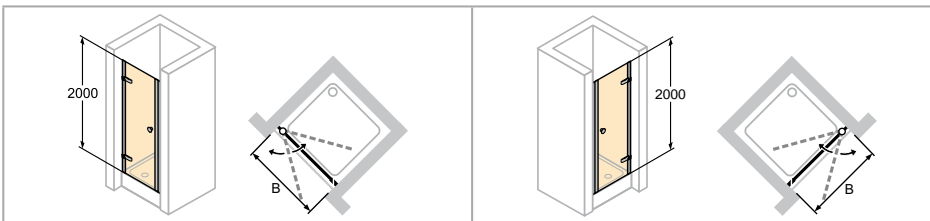

Left-hand fixing

Right-hand fixing

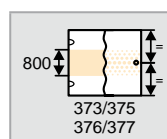
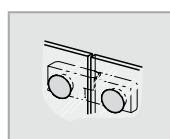
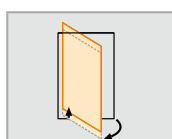
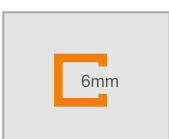
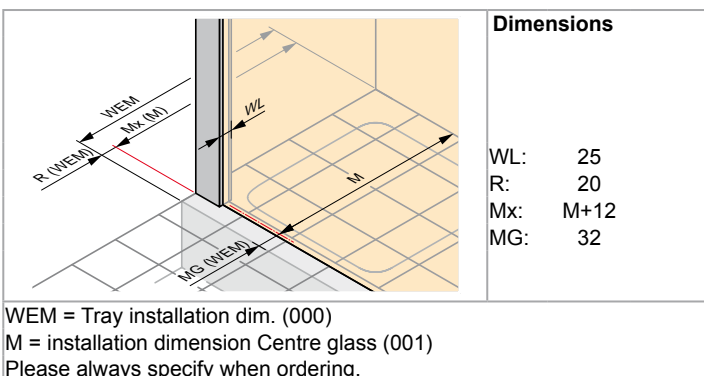

HÜPPE Enjoy elegance partially framed Rectangular

HÜPPE Enjoy pure partially framed Rectangular

Swing door in recess

Left-hand fixing

Height	Model	WEM B	M (middle of glass) B	Entry width	elegance	pure	Base price
2000	800	770-805	770-805	677	3T1801	4T1801	1.257,-
	900	870-905	870-905	777	3T1802	4T1802	
	1000	970-1005	970-1005	877	3T1803	4T1803	1.310,-

Made-to-measure - Left-hand fixing

Height	Width B	elegance	pure	Base price
1600-2000	700-1000	3T1880	4T1880	1.634,-

Adjustment range = dimensions - 18mm / + 17mm

Right-hand fixing

Height	Model	WEM B	M (middle of glass) B	Entry width	elegance	pure	Base price
2000	800	770-805	770-805	677	3T1901	4T1901	1.257,-
	900	870-905	870-905	777	3T1902	4T1902	
	1000	970-1005	970-1005	877	3T1903	4T1903	1.310,-

Made-to-measure - Right-hand fixing

Height	Width B	elegance	pure	Base price
1600-2000	700-1000	3T1980	4T1980	1.634,-

Adjustment range = dimensions - 18mm / + 17mm

Slopes and cut-outs

Slopes and cut-outs	Extra charges
 Supplement per slope/cut-out for made-to-measure	170,-

Dim. Range: min. - max.

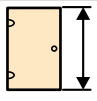
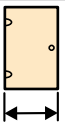
	
1600-2000	700-1000

Special options

Optional variants	Extra charges
Comfort handle	800
	57,-

Colours - Panel options

Profile colours	Colour code	Extra charges	Panel options	without Anti-Plaque		with Anti-Plaque	
				Glass code	Extra charges	Glass code	Extra charges
White	055	0,-	Clear	321	0,-	322	209,-
Matt silver	087		Sand Plus	315		316	
Silver high-gloss	092		Privatima	373	186,-	375	395,-
			Bubbles	376		377	
			Mirror glass	380	439,-	381	648,-

HÜPPE Enjoy elegance partially framed Rectangular

HÜPPE Enjoy pure partially framed Rectangular

elegance



pure

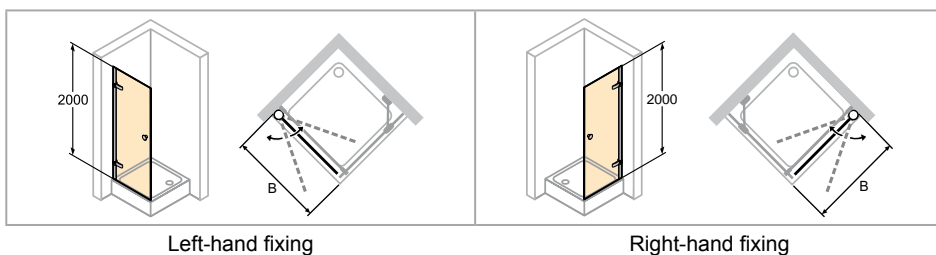

Left-hand fixing

Right-hand fixing

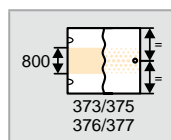
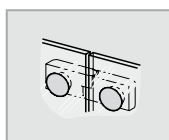
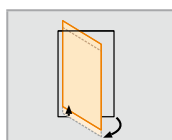
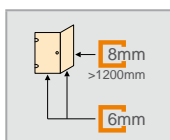
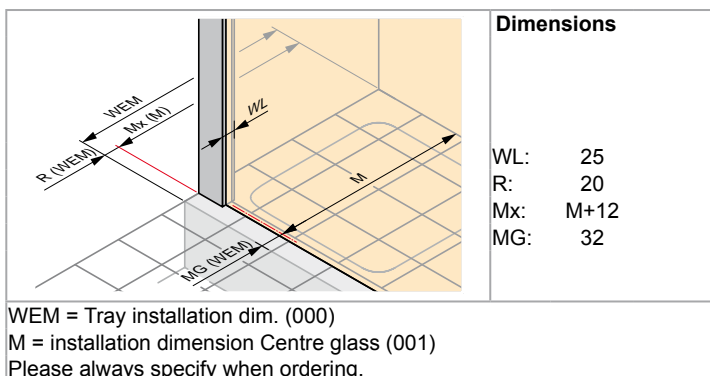

Swing door for side panel

Left-hand fixing

Installation on shower tray recommended

Height	Model	WEM B	M (middle of glass) B	Entry width	elegance	pure	Base price
2000	800	790-805	758-773	690	3T2001	4T2001	1.257,-
	900	890-905	858-873	790	3T2002	4T2002	
	1000	990-1005	958-973	890	3T2003	4T2003	1.310,-

Left-hand fixing

Floor-flush installation recommended

Height	Model	M (middle of glass) B	Entry width	elegance	pure	Base price
2000	800	792-807	722	3T2004	4T2004	1.257,-
	900	892-907	822	3T2005	4T2005	
	1000	992-1007	922	3T2006	4T2006	1.310,-

Made-to-measure - Left-hand fixing

Height	Width B	elegance	pure	Base price
1600-2000	700-1000	3T2080	4T2080	1.634,-

Adjustment range = dimensions - 8mm / + 7mm

Right-hand fixing

Installation on shower tray recommended

Height	Model	WEM B	M (middle of glass) B	Entry width	elegance	pure	Base price
2000	800	790-805	758-773	690	3T2101	4T2101	1.257,-
	900	890-905	858-873	790	3T2102	4T2102	
	1000	990-1005	958-973	890	3T2103	4T2103	1.310,-

Right-hand fixing

Floor-flush installation recommended

Height	Model	M (middle of glass) B	Entry width	elegance	pure	Base price
2000	800	792-807	722	3T2104	4T2104	1.257,-
	900	892-907	822	3T2105	4T2105	
	1000	992-1007	922	3T2106	4T2106	1.310,-

Made-to-measure - Right-hand fixing



Height	Width B	elegance	pure	Base price
1600-2000	700-1000	3T2180	4T2180	1.634,-

Adjustment range = dimensions - 8mm / + 7mm

Slopes and cut-outs

Slopes and cut-outs	Extra charges
 Supplement per slope/cut-out for made-to-measure	170,-

Dim. Range: min. - max.

	
1600-2000	700-1000

Special options

Optional variants	Extra charges
Comfort handle	800
	57,-

Colours - Panel options

Profile colours	Colour code	Extra charges	Panel options	without Anti-Plaque		with Anti-Plaque	
				Glass code	Extra charges	Glass code	Extra charges
White	055	0,-	Clear	321	0,-	322	209,-
Matt silver	087		Sand Plus	315		316	
Silver high-gloss	092		Privatima	373	186,-	375	395,-
			Bubbles	376		377	
			Mirror glass	380	439,-	381	648,-

HÜPPE Enjoy elegance partially framed Rectangular

HÜPPE Enjoy pure partially framed Rectangular

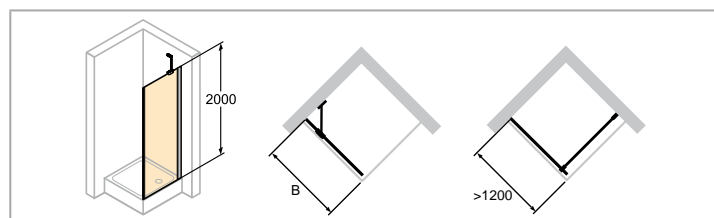
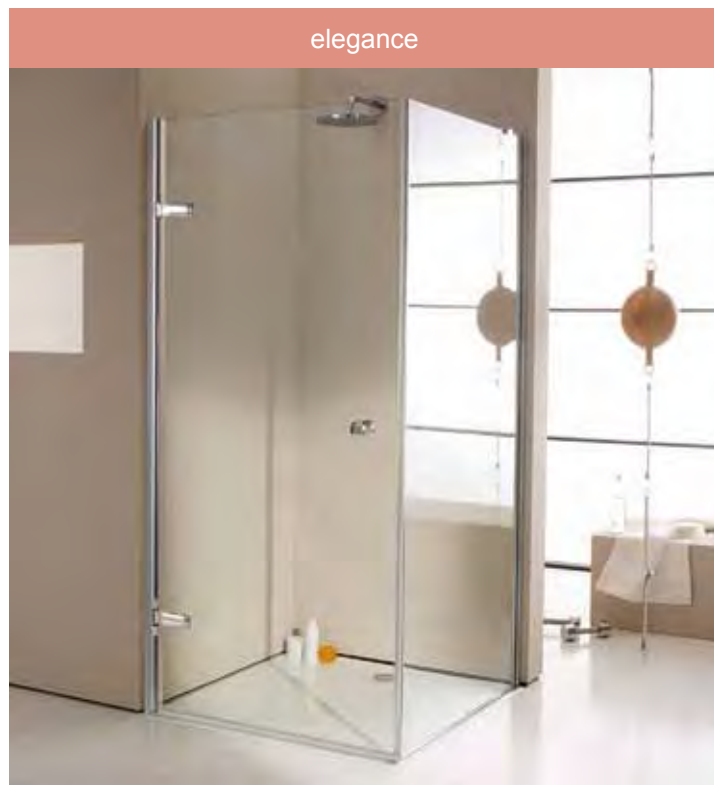

- Shortened side panel can only be combined with door in recess.
- Towel rail height can be selected individually and must be specified with the order. If nothing is specified, the towel rail is always delivered middle of glass (height and width).

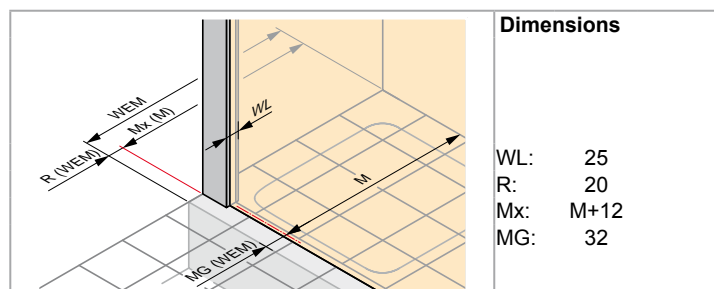

WEM = Tray installation dim. (000)
M = installation dimension Centre glass (001)
Please always specify when ordering.

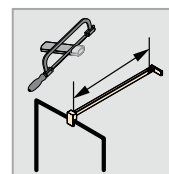
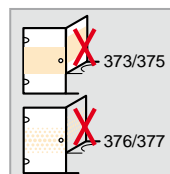
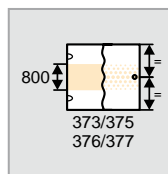
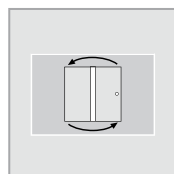
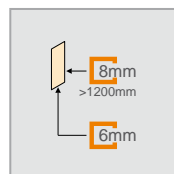

HÜPPE Enjoy elegance partially framed Rectangular

HÜPPE Enjoy pure partially framed Rectangular

Side panel for swing door

Installation on shower tray recommended

Height	Model	WEM B	M (middle of glass) B	elegance	pure	Base price
2000	SW 750	735-755	703-723	3T3001	4T3001	851,-
	SW 800	785-805	753-773	3T3002	4T3002	
	SW 900	885-905	853-873	3T3003	4T3003	
	SW 1000	985-1005	953-973	3T3004	4T3004	887,-
1750	SWK 800	785-805	753-773	3T3005	4T3005	851,-
	SWK 900	885-905	853-873	3T3006	4T3006	
	SWK 1000	985-1005	953-973	3T3007	4T3007	887,-

Floor-flush installation recommended

Height	Model	M (middle of glass) B	elegance	pure	Base price
2000	SW 750	740-760	3T3008	4T3008	851,-
	SW 800	790-810	3T3009	4T3009	
	SW 900	890-910	3T3010	4T3010	
	SW 1000	990-1010	3T3011	4T3011	887,-

Made-to-measure



Height	Model	Width B	Fixing	elegance	pure	Base price
1600-2000	Standard made-to-measure	200-1200	Stabilizer	3T3080	4T3080	1.106,-
	Standard made-to-measure	1201-1600	Cross bar	3T3083	4T3083	1.500,-
400-1750	On bath tub - only with door in recess	200-1200	Stabilizer	3T3081	4T3081	1.106,-
	On bath tub - only with door in recess	1201-1600	Cross bar	3T3082	4T3082	1.500,-

Adjustment range = dimensions - 10mm / + 10mm

Slopes and cut-outs

Slopes and cut-outs	Extra charges
 Supplement per slope/cut-out for made-to-measure	170,-

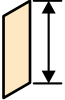
Dim. Range: min. - max.

	
1600-2000	200-1600

Special options

Special options	Extra charges
Towel rail (silver high-gloss)	T99 210,-

Colours - Panel options

Profile colours	Colour code	Extra charges	Panel options	without Anti-Plaque		with Anti-Plaque	
				Glass code	Extra charges	Glass code	Extra charges
White	055	0,-	Clear	321	0,-	322	209,-
Matt silver	087		Sand Plus	315		316	
Silver high-gloss	092		Privatima	373	186,-	375	395,-
			Bubbles	376		377	
			Mirror glass	380	439,-	381	648,-

HÜPPE Enjoy elegance partially framed Rectangular

HÜPPE Enjoy pure partially framed Rectangular

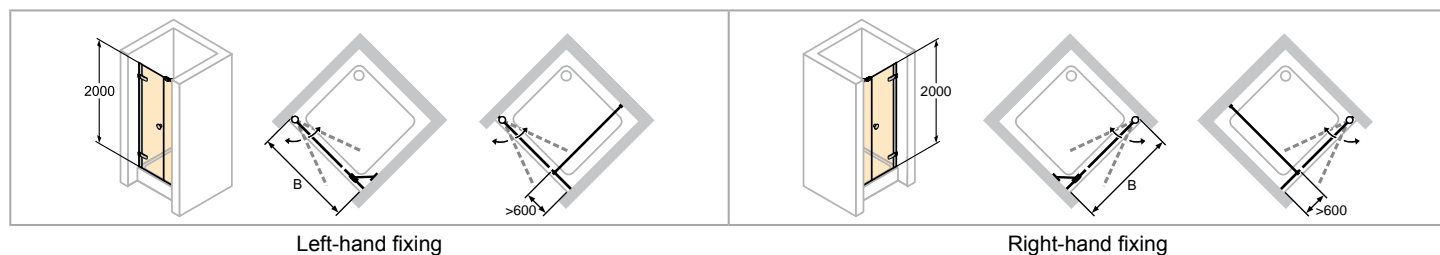
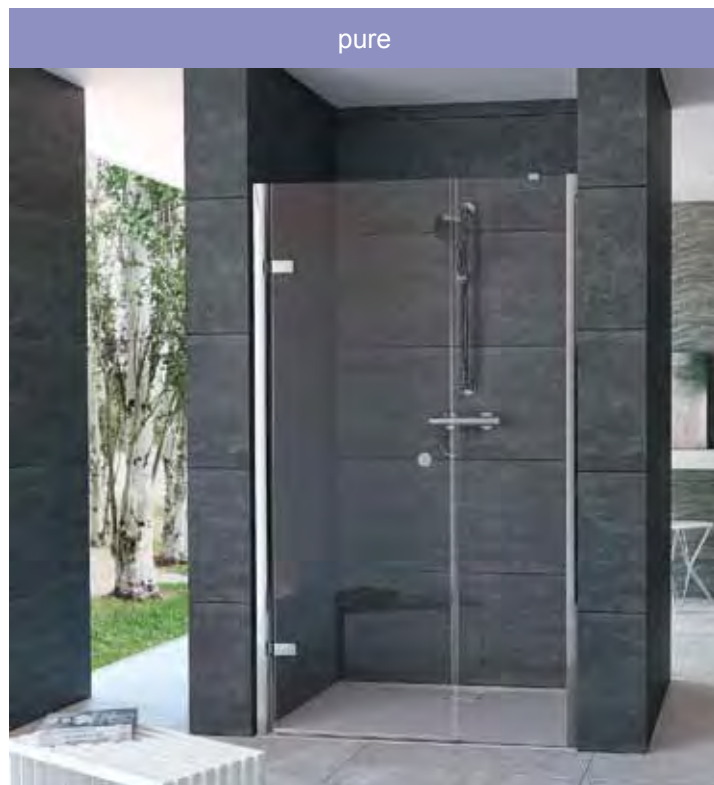
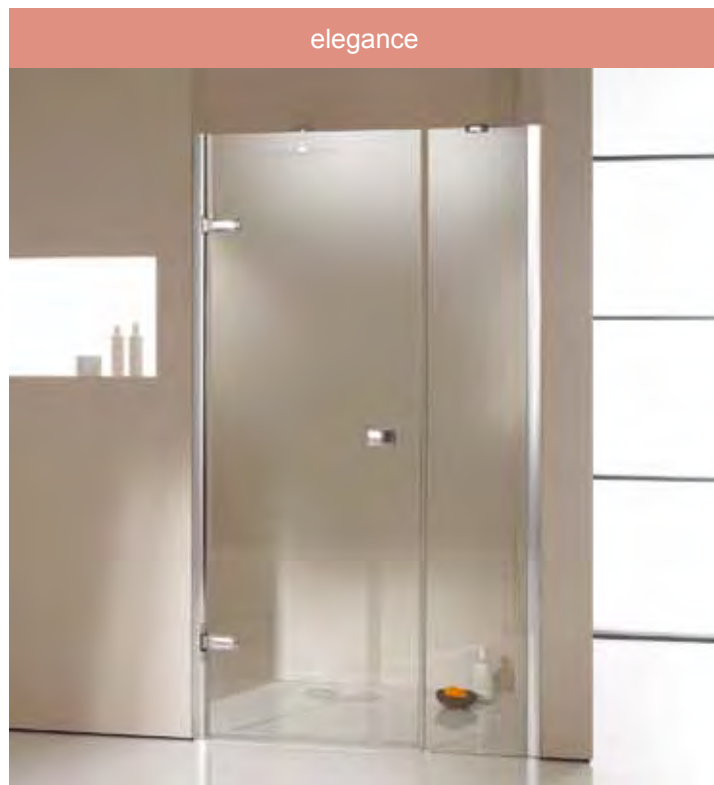

Left-hand fixing

Right-hand fixing

- Mirror glass (380/381): Please state in your order which segment should be produced with mirror glass. If this is not stated, the entire unit will be produced with mirror glass.
- For technical information, see Profile Colours and Panel Options section.

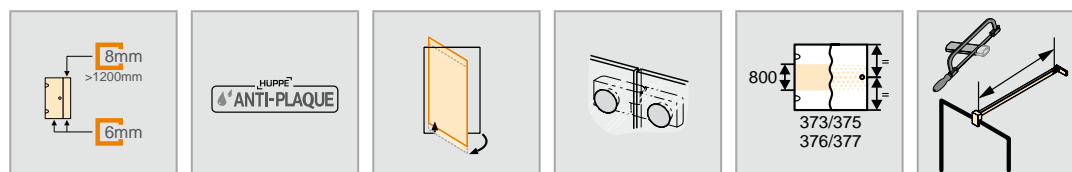
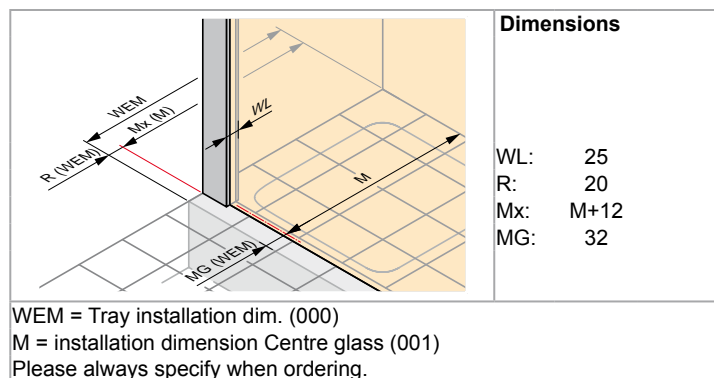

Swing door with additional section in recess

Left-hand fixing

Height	Model	WEM B	M (middle of glass) B	Additional section width	Entry width	elegance	pure	Base price
2000	800	770-805	770-805	209-229	502	3T3101	4T3101	1.257,-
	900	870-905	870-905	209-229	602	3T3102	4T3102	
	1000	970-1005	970-1005	209-229	702	3T3103	4T3103	1.310,-
	1200	1170-1205	1170-1205	409-429	702	3T3104	4T3104	1.333,-

Made-to-measure - Left-hand fixing

Height	Width B	Door width	elegance	pure	Base price
1600-2000	700-1200	max. 1000	3T3180	4T3180	1.634,-
	1201-2600	max. 1000	3T3181	4T3181	2.027,-

Adjustment range = dimensions - 18mm / + 17mm

The width of the additional section must be stated.

Right-hand fixing

Height	Model	WEM B	M (middle of glass) B	Additional section width	Entry width	elegance	pure	Base price
2000	800	770-805	770-805	209-229	502	3T3201	4T3201	1.257,-
	900	870-905	870-905	209-229	602	3T3202	4T3202	
	1000	970-1005	970-1005	209-229	702	3T3203	4T3203	1.310,-
	1200	1170-1205	1170-1205	409-429	702	3T3204	4T3204	1.333,-

Made-to-measure - Right-hand fixing

Height	Width B	Door width	elegance	pure	Base price
1600-2000	700-1200	max. 1000	3T3280	4T3280	1.634,-
	1201-2600	max. 1000	3T3281	4T3281	2.027,-

Adjustment range = dimensions - 18mm / + 17mm

The width of the additional section must be stated.

Slopes and cut-outs

Slopes and cut-outs	Extra charges
	Supplement per slope/cut-out for made-to-measure 170,-

Dim. Range: min. - max.

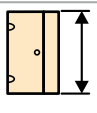
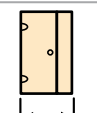
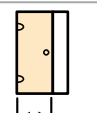
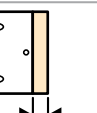
			
1600-2000	700-2600	max. 1000	116-1600

Special options

Optional variants	Extra charges
Comfort handle	800 57,-

Colours - Panel options

Profile colours	Colour code	Extra charges	Panel options	without Anti-Plaque		with Anti-Plaque	
				Glass code	Extra charges	Glass code	Extra charges
White	055	0,- 156,-	Clear	321	0,-	322	209,-
Matt silver	087		Sand Plus	315		316	
Silver high-gloss	092		Privatima	373	186,-	375	395,-
			Bubbles	376		377	
			Mirror glass	380	439,-	381	648,-

HÜPPE Enjoy elegance partially framed Rectangular

HÜPPE Enjoy pure partially framed Rectangular

elegance



pure

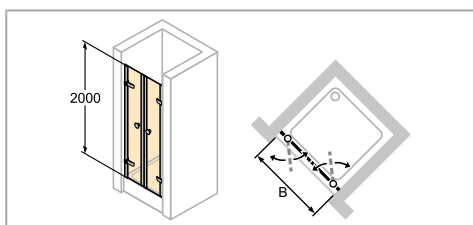

- Mirror glass (380/381): Please state in your order which segment should be produced with mirror glass. If this is not stated, the entire unit will be produced with mirror glass.
- For technical information, see Profile Colours and Panel Options section.

	<p>Dimensions</p> <p>WL: 25 R: 20 Mx: M+12 MG: 32</p>
<p>WEM = Tray installation dim. (000) M = installation dimension Centre glass (001) Please always specify when ordering.</p>	

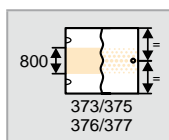
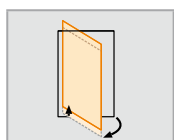
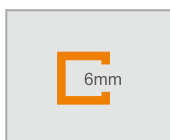

HÜPPE Enjoy elegance partially framed Rectangular

HÜPPE Enjoy pure partially framed Rectangular

Two-way door in recess

Height	Model	WEM B	M (middle of glass) B	Entry width	elegance	pure	Base price
2000	800	775-805	775-805	675	3T2401	4T2401	1.656,-
	900	875-905	875-905	775	3T2402	4T2402	
	1000	975-1005	975-1005	875	3T2403	4T2403	1.721,-
	1100	1075-1105	1075-1105	975	3T2404	4T2404	
	1200	1175-1205	1175-1205	1075	3T2405	4T2405	1.754,-

Made-to-measure

Height	Width B	elegance	pure	Base price
1600-2000	600-1200	3T2480	4T2480	2.153,-
	1201-1600	3T2481	4T2481	2.546,-

Adjustment range = dimensions - 15mm / + 15mm

Dim. Range: min. - max.

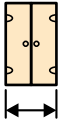
	
1600-2000	600-1600

Special options

Optional variants		Extra charges
Comfort handle	800	114,-

Colours - Panel options

Profile colours	Colour code	Extra charges	Panel options	without Anti-Plaque		with Anti-Plaque	
				Glass code	Extra charges	Glass code	Extra charges
White	055	0,-	Clear	321	0,-	322	209,-
Matt silver	087		Sand Plus	315		316	
Silver high-gloss	092		Privatima	373	186,-	375	395,-
			Bubbles	376		377	
			Mirror glass	380	439,-	381	648,-

HÜPPE Enjoy elegance partially framed Rectangular

HÜPPE Enjoy pure partially framed Rectangular

elegance



pure

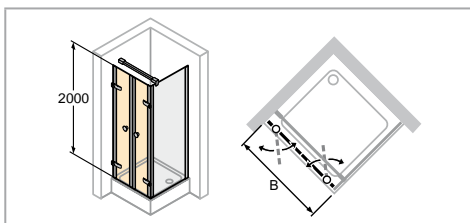

- Mirror glass (380/381): Please state in your order which segment should be produced with mirror glass. If this is not stated, the entire unit will be produced with mirror glass.
- For technical information, see Profile Colours and Panel Options section.

	<p>Dimensions</p> <p>WL: 25 R: 20 Mx: M+12 MG: 32</p>
<p>WEM = Tray installation dim. (000) M = installation dimension Centre glass (001) Please always specify when ordering.</p>	

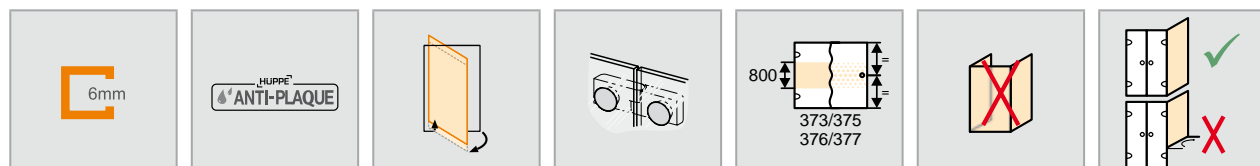

Two-way door for side panel

Installation on shower tray recommended

Height	Model	WEM B	M (middle of glass) B	Entry width	elegance	pure	Base price
2000	800	775-805	743-773	649	3T2201	4T2201	1.656,-
	900	875-905	843-873	749	3T2202	4T2202	
	1000	975-1005	943-973	849	3T2203	4T2203	1.721,-
	1100	1075-1105	1043-1073	949	3T2204	4T2204	
	1200	1175-1205	1143-1173	1049	3T2205	4T2205	1.754,-

Floor-flush installation recommended



Height	Model	M (middle of glass) B	Entry width	elegance	pure	Base price
2000	800	785-815	681	3T2206	4T2206	1.656,-
	900	885-915	781	3T2207	4T2207	
	1000	985-1015	881	3T2208	4T2208	1.721,-
	1100	1085-1115	981	3T2209	4T2209	
	1200	1185-1215	1081	3T2210	4T2210	1.754,-

Made-to-measure

Height	Width B	elegance	pure	Base price
1600-2000	600-1200	3T2280	4T2280	2.153,-

Adjustment range = dimensions - 15mm / + 15mm

Dim. Range: min. - max.

	
1600-2000	600-1200

Special options

Optional variants		Extra charges
Comfort handle	800	114,-

Colours - Panel options

Profile colours	Colour code	Extra charges	Panel options	
			without Anti-Plaque Glass code	with Anti-Plaque Glass code
White	055	0,-	321	322
Matt silver	087		315	316
Silver high-gloss	092	156,-	373	375
			376	377
			380	381
			439,-	648,-

HÜPPE Enjoy elegance partially framed Rectangular

HÜPPE Enjoy pure partially framed Rectangular

elegance



pure

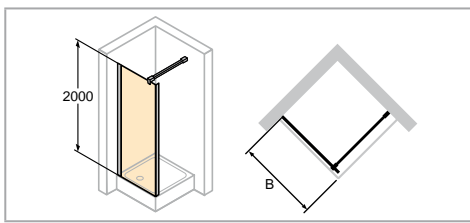

- Not suitable as a free-standing side panel.
- Shortened side panel not available.
- Towel rail height can be selected individually and must be specified with the order. If nothing is specified, the towel rail is always delivered middle of glass (height and width).

	<p>Dimensions</p> <p>WL: 26 R: 20 Mx: M+12 MG: 32</p>
<p>WEM = Tray installation dim. (000) M = installation dimension Centre glass (001) Please always specify when ordering.</p>	

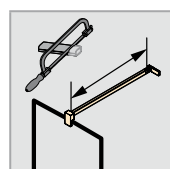
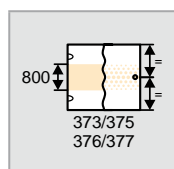
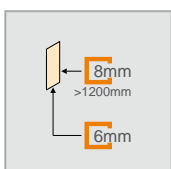

Side panel for two-way door

Left-hand fixing

Installation on shower tray recommended

Height	Model	WEM B	M (middle of glass) B	elegance	pure	Base price
2000	SW 750	735-755	703-723	3T2701	4T2701	851,-
	SW 800	785-805	753-773	3T2702	4T2702	
	SW 900	885-905	853-873	3T2703	4T2703	
	SW 1000	985-1005	953-973	3T2704	4T2704	887,-
	SW 1200	1185-1205	1153-1173	3T2705	4T2705	902,-

Left-hand fixing

Floor-flush installation recommended

Height	Model	M (middle of glass) B	elegance	pure	Base price
2000	SW 750	740-760	3T2706	4T2706	851,-
	SW 800	790-810	3T2707	4T2707	
	SW 900	890-910	3T2708	4T2708	
	SW 1000	990-1010	3T2709	4T2709	887,-
	SW 1200	1190-1210	3T2710	4T2710	902,-

Made-to-measure - Left-hand fixing

Height	Width B	elegance	pure	Base price
1600-2000	400-1200	3T2780	4T2780	1.106,-
	1201-1600	3T2781	4T2781	1.500,-

Adjustment range = dimensions - 10mm / + 10mm

Slopes and cut-outs

Slopes and cut-outs	Extra charges
 Supplement per slope/cut-out for made-to-measure	170,-

Dim. Range: min. - max.

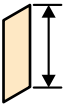
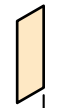
	
1600-2000	400-1600

Special options

Special options	Extra charges
Towel rail (silver high-gloss)	T99 210,-

Colours - Panel options

Profile colours	Colour code	Extra charges	Panel options				
			without Anti-Plaque Glass code	with Anti-Plaque Glass code			
White	055	0,- 114,-	Clear	321	0,-	322	209,-
Matt silver	087		Sand Plus	315		316	
Silver high-gloss	092		Privatima	373	186,-	375	395,-
			Bubbles	376		377	
			Mirror glass	380	439,-	381	648,-

HÜPPE Enjoy elegance partially framed Rectangular

HÜPPE Enjoy pure partially framed Rectangular

elegance



pure

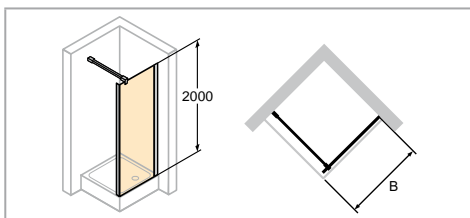

- Not suitable as a free-standing side panel.
- Shortened side panel not available.
- Towel rail height can be selected individually and must be specified with the order. If nothing is specified, the towel rail is always delivered middle of glass (height and width).

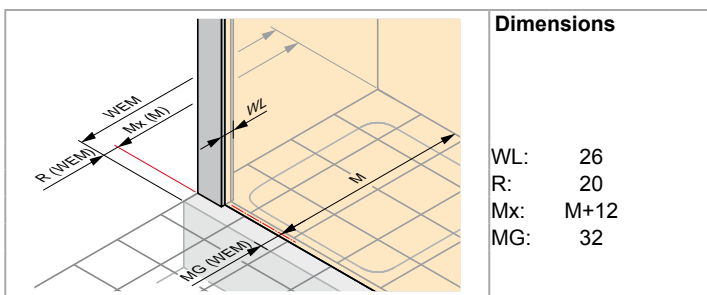

WEM = Tray installation dim. (000)
M = installation dimension Centre glass (001)
Please always specify when ordering.

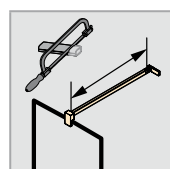
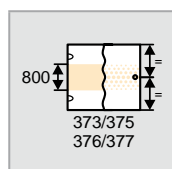
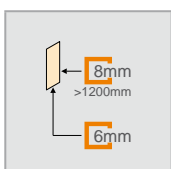

Side panel for two-way door

Right-hand fixing

Installation on shower tray recommended

Height	Model	WEM B	M (middle of glass) B	elegance	pure	Base price
2000	SW 750	735-755	703-723	3T2801	4T2801	851,-
	SW 800	785-805	753-773	3T2802	4T2802	
	SW 900	885-905	853-873	3T2803	4T2803	
	SW 1000	985-1005	953-973	3T2804	4T2804	887,-
	SW 1200	1185-1205	1153-1173	3T2805	4T2805	902,-

Right-hand fixing

Floor-flush installation recommended

Height	Model	M (middle of glass) B	elegance	pure	Base price
2000	SW 750	740-760	3T2806	4T2806	851,-
	SW 800	790-810	3T2807	4T2807	
	SW 900	890-910	3T2808	4T2808	
	SW 1000	990-1010	3T2809	4T2809	887,-
	SW 1200	1190-1210	3T2810	4T2810	902,-

Made-to-measure - Right-hand fixing



Height	Width B	elegance	pure	Base price
1600-2000	400-1200	3T2880	4T2880	1.106,-
	1201-1600	3T2881	4T2881	1.500,-

Adjustment range = dimensions - 10mm / + 10mm

Slopes and cut-outs

Slopes and cut-outs	Extra charges
 Supplement per slope/cut-out for made-to-measure	170,-

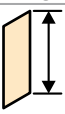
Dim. Range: min. - max.

	
1600-2000	400-1600

Special options

Special options	Extra charges
Towel rail (silver high-gloss)	T99 210,-

Colours - Panel options

Profile colours	Colour code	Extra charges	Panel options	
			without Anti-Plaque Glass code	with Anti-Plaque Glass code
White	055	0,-	321	322
Matt silver	087		315	316
Silver high-gloss	092	114,-	373	375
			376	377
			380	381
			439,-	648,-

HÜPPE Enjoy elegance partially framed Quadrant

HÜPPE Enjoy pure partially framed Quadrant

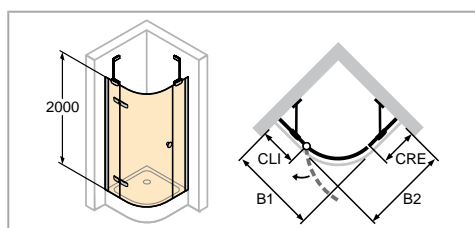
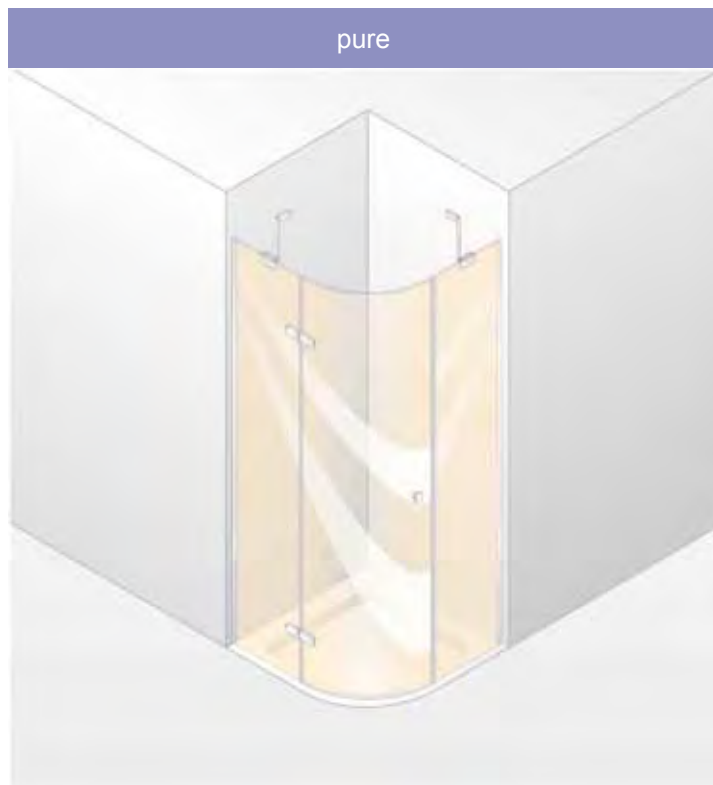
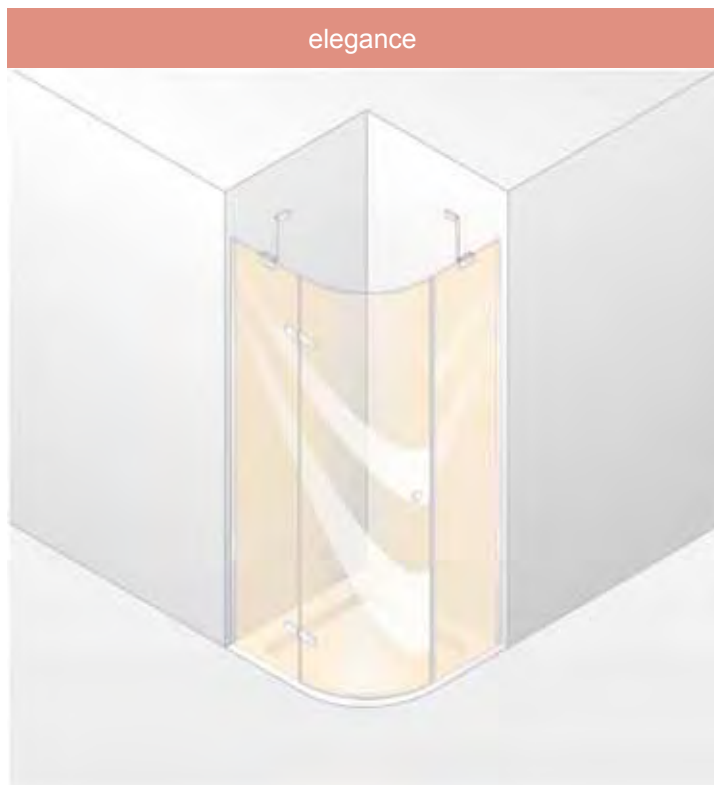

	<p>Dimensions</p> <p>WL: 26 R: 20 Mx: M+12 MG: 32</p>
<p>WEM = Tray installation dim. (000) M = installation dimension Centre glass (001) Please always specify when ordering.</p>	

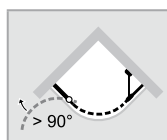
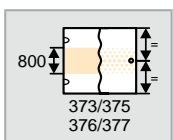
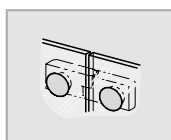
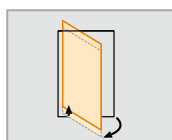
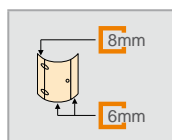

Swing door with fixed segments, 1-panel

Left-hand fixing

Installation on shower tray recommended

Height	Model B1/ B2	WEM B1	WEM B2	M (middle of glass) B1	M (middle of glass) B2	CLI	CRE	Entry width	Radius	elegance	pure	Base price
2000	900 x 900	885-905	885-905	853-873	853-873	266-286	363-383	745	500	3T3401	4T3401	2.488,-
	1000 x 1000	985-1005	985-1005	953-973	953-973	366-386	463-483	745	500	3T3402	4T3402	2.588,-
	900 x 1000	885-905	985-1005	853-873	953-973	266-286	463-483	745	500	3T3403	4T3403	
	1000 x 900	985-1005	885-905	953-973	853-873	366-386	363-383	745	500	3T3404	4T3404	
	900 x 1200	885-905	1185-1205	853-873	1153-1173	266-286	663-683	745	500	3T3405	4T3405	2.638,-
	1200 x 900	1185-1205	885-905	1153-1173	853-873	566-586	363-383	745	500	3T3406	4T3406	2.488,-
	900 x 900	885-905	885-905	853-873	853-873	219-239	317-337	810	550	3T3413	4T3413	
	1000 x 1000	985-1005	985-1005	953-973	953-973	319-339	417-437	810	550	3T3414	4T3414	
	900 x 1000	885-905	985-1005	853-873	953-973	219-239	417-437	810	550	3T3415	4T3415	
	1000 x 900	985-1005	885-905	953-973	853-873	319-339	317-337	810	550	3T3416	4T3416	

Left-hand fixing

Floor-flush installation recommended

Height	Model B1/B2	M (middle of glass) B1	M (middle of glass) B2	CLI	CRE	Entry width	Radius	elegance	pure	Base price
2000	900 x 900	890-910	890-910	298-318	395-415	745	500	3T3407	4T3407	2.488,-
	1000 x 1000	990-1010	990-1010	398-418	495-515	745	500	3T3408	4T3408	2.588,-
	900 x 1000	890-910	990-1010	298-318	495-515	745	500	3T3409	4T3409	
	1000 x 900	990-1010	890-910	398-418	395-415	745	500	3T3410	4T3410	
	900 x 1200	890-910	1190-1210	298-318	695-715	745	500	3T3411	4T3411	2.638,-
	1200 x 900	1190-1210	890-910	598-618	395-415	745	500	3T3412	4T3412	2.488,-
	900 x 900	890-910	890-910	251-271	349-369	810	550	3T3417	4T3417	
	1000 x 1000	990-1010	990-1010	351-371	449-469	810	550	3T3418	4T3418	
	900 x 1000	890-910	990-1010	251-271	449-469	810	550	3T3419	4T3419	
	1000 x 900	990-1010	890-910	351-371	349-369	810	550	3T3420	4T3420	

Made-to-measure - Left-hand fixing



Height	Width	CLI	CRE	Entry width	Radius	elegance	pure	Base price
2000	900-1200	210-600	210-600	745	500	3T3480	4T3480	3.234,-
	900-1200	210-600	210-600	810	550	3T3481	4T3481	

Adjustment range = dimensions - 10mm / + 10mm

Slopes and cut-outs

Slopes and cut-outs	Extra charges
 Supplement per slope/cut-out for made-to-measure	170,-

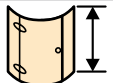
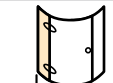
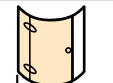
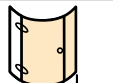
Dim. Range: min. - max.

				
2000	210-600	900-1200	900-1200	210-600

Special options

Optional variants	Extra charges
Comfort handle	800
	57,-

Colours - Panel options

Profile colours	Colour code	Extra charges	Panel options	without Anti-Plaque		with Anti-Plaque	
				Glass code	Extra charges	Glass code	Extra charges
White	055	0,-	Clear	321	0,-	322	418,-
Matt silver	087		Sand Plus	315		316	
Silver high-gloss	092	312,-	Privatima	373	371,-	375	789,-
			Bubbles	376		377	

HÜPPE Enjoy elegance partially framed Quadrant

HÜPPE Enjoy pure partially framed Quadrant

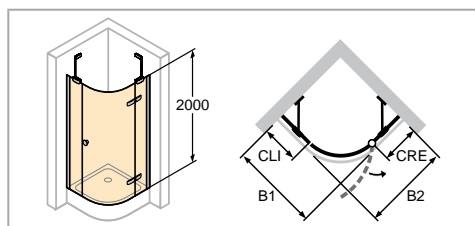
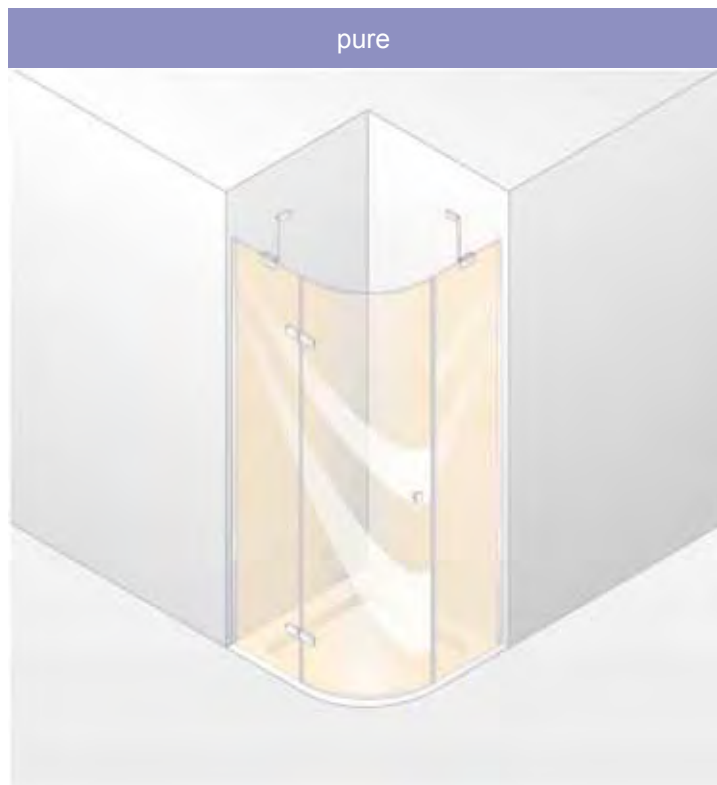
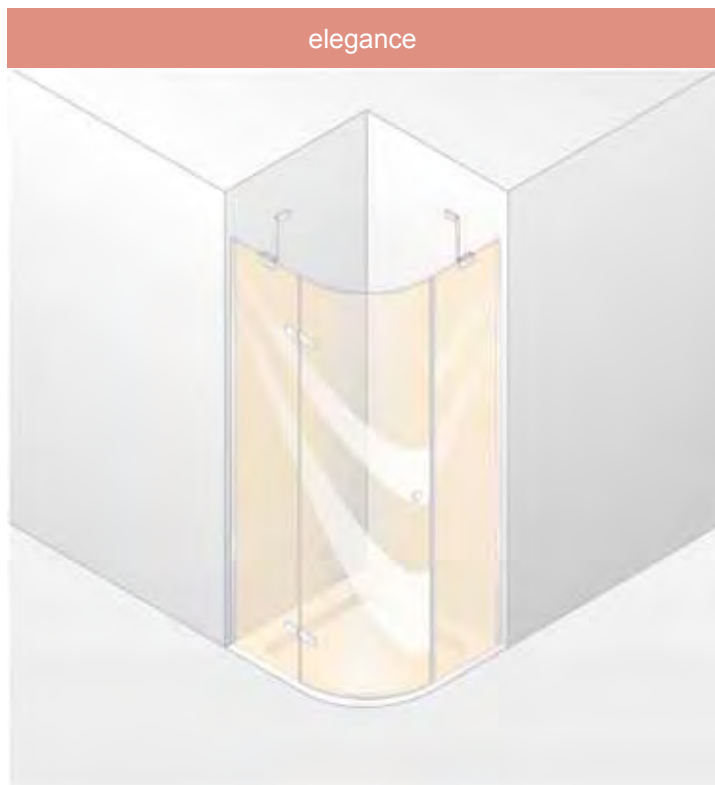

Dimensions	
WL:	26
R:	20
Mx:	M+12
MG:	32

WEM = Tray installation dim. (000)
M = installation dimension Centre glass (001)
Please always specify when ordering.

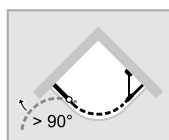
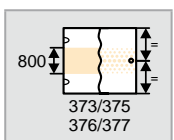
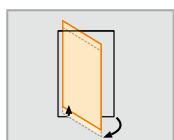
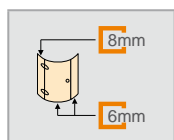

Swing door with fixed segments, 1-panel

Right-hand fixing

Installation on shower tray recommended

Height	Model B1/ B2	WEM B1	WEM B2	M (middle of glass) B1	M (middle of glass) B2	CLI	CRE	Entry width	Radius	elegance	pure	Base price
2000	900 x 900	885-905	885-905	853-873	853-873	363-383	266-286	745	500	3T3501	4T3501	2.488,-
	1000 x 1000	985-1005	985-1005	953-973	953-973	463-483	366-386	745	500	3T3502	4T3502	2.588,-
	900 x 1000	885-905	985-1005	853-873	953-973	363-383	366-386	745	500	3T3503	4T3503	
	1000 x 900	985-1005	885-905	953-973	853-873	463-483	266-286	745	500	3T3504	4T3504	2.638,-
	900 x 1200	885-905	1185-1205	853-873	1153-1173	363-483	566-586	745	500	3T3505	4T3505	
	1200 x 900	1185-1205	885-905	1153-1173	853-873	663-683	266-286	745	500	3T3506	4T3506	
	900 x 900	885-905	885-905	853-873	853-873	317-337	219-239	810	550	3T3513	4T3513	2.488,-
	1000 x 1000	985-1005	985-1005	953-973	953-973	417-437	319-339	810	550	3T3514	4T3514	2.588,-
	900 x 1000	885-905	985-1005	853-873	953-973	317-337	319-339	810	550	3T3515	4T3515	
	1000 x 900	985-1005	885-905	953-973	853-873	417-437	219-239	810	550	3T3516	4T3516	

Right-hand fixing

Floor-flush installation recommended

Height	Model B1/B2	M (middle of glass) B1	M (middle of glass) B2	CLI	CRE	Entry width	Radius	elegance	pure	Base price
2000	900 x 900	890-910	890-910	395-415	298-318	745	500	3T3507	4T3507	2.488,-
	1000 x 1000	990-1010	990-1010	495-515	398-418	745	500	3T3508	4T3508	2.588,-
	900 x 1000	890-910	990-1010	395-415	398-418	745	500	3T3509	4T3509	
	1000 x 900	990-1010	890-910	495-515	298-318	745	500	3T3510	4T3510	2.638,-
	900 x 1200	890-910	1190-1210	395-415	598-618	745	500	3T3511	4T3511	
	1200 x 900	1190-1210	890-910	695-715	298-318	745	500	3T3512	4T3512	
	900 x 900	890-910	890-910	349-369	251-271	810	550	3T3517	4T3517	2.488,-
	1000 x 1000	990-1010	990-1010	449-469	351-371	810	550	3T3518	4T3518	2.588,-
	900 x 1000	890-910	990-1010	349-469	351-371	810	550	3T3519	4T3519	
	1000 x 900	990-1010	890-910	449-469	251-271	810	550	3T3520	4T3520	

Made-to-measure - Right-hand fixing

Height	Width	CLI	CRE	Entry width	Radius	elegance	pure	Base price
2000	900-1200	210-600	210-600	745	500	3T3580	4T3580	3.234,-
	900-1200	210-600	210-600	810	550	3T3581	4T3581	

Adjustment range = dimensions - 10mm / + 10mm

Slopes and cut-outs

Slopes and cut-outs	Extra charges
 Supplement per slope/cut-out for made-to-measure	170,-

Dim. Range: min. - max.

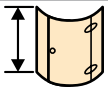
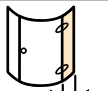
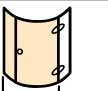
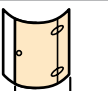
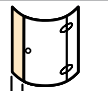
				
2000	210-600	900-1200	900-1200	210-600

Special options

Optional variants	Extra charges
Comfort handle	800
	57,-

Colours - Panel options

Profile colours	Colour code	Extra charges	Panel options	without Anti-Plaque		with Anti-Plaque	
				Glass code	Extra charges	Glass code	Extra charges
White	055	0,-	Clear	321	0,-	322	418,-
Matt silver	087		Sand Plus	315		316	
Silver high-gloss	092	312,-	Privatima	373	371,-	375	789,-
			Bubbles	376		377	

HÜPPE Enjoy elegance partially framed Quadrant

HÜPPE Enjoy pure partially framed Quadrant

elegance



pure

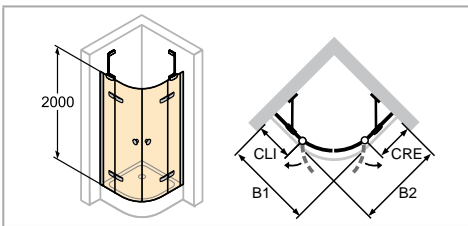

	<p>Dimensions</p> <p>WL: 26 R: 20 Mx: M+12 MG: 32</p>
<p>WEM = Tray installation dim. (000) M = installation dimension Centre glass (001) Please always specify when ordering.</p>	

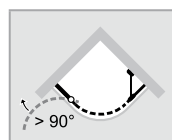
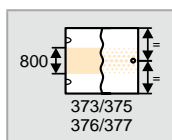
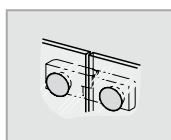
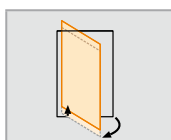
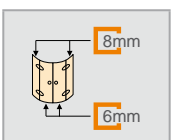

Swing door with fixed segments, 2-panel

Installation on shower tray recommended

Height	Model B1/B2	WEM B1	WEM B2	M (middle of glass) B1	M (middle of glass) B2	CLI	CRE	Entry width	Radius	elegance	pure	Base price
2000	900 x 900	885-905	885-905	853-873	853-873	266-286	266-286	810	500	3T1502	4T1502	2.488,-
	1000 x 1000	985-1005	985-1005	953-973	953-973	366-386	366-386	810	500	3T1503	4T1503	
	900 x 1000	885-905	985-1005	853-873	953-973	266-286	366-386	810	500	3T1504	4T1504	
	1000 x 900	985-1005	885-905	953-973	853-873	366-386	266-286	810	500	3T1505	4T1505	
	900 x 1200	885-905	1185-1205	853-873	1153-1173	266-286	566-586	810	500	3T1508	4T1508	2.638,-
	1200 x 900	1185-1205	885-905	1153-1173	853-873	566-586	266-286	810	500	3T1509	4T1509	
	900 x 900	885-905	885-905	853-873	853-873	219-239	219-239	880	550	3T1506	4T1506	2.488,-
	1000 x 1000	985-1005	985-1005	953-973	953-973	319-339	319-339	880	550	3T1507	4T1507	2.588,-
	900 x 1000	885-905	985-1005	853-873	953-973	219-239	319-339	880	550	3T1510	4T1510	
1000 x 900	985-1005	885-905	953-973	853-873	319-339	219-239	880	550	3T1511	4T1511		

Floor-flush installation recommended

Height	Model B1/B2	M (middle of glass) B1	M (middle of glass) B2	CLI	CRE	Entry width	Radius	elegance	pure	Base price
2000	900 x 900	890-910	890-910	298-318	298-318	810	500	3T1512	4T1512	2.488,-
	1000 x 1000	990-1010	990-1010	398-418	398-418	810	500	3T1513	4T1513	
	900 x 1000	890-910	990-1010	298-318	398-418	810	500	3T1514	4T1514	
	1000 x 900	990-1010	890-910	398-418	298-318	810	500	3T1515	4T1515	
	900 x 1200	890-910	1190-1210	298-318	598-618	810	500	3T1516	4T1516	2.638,-
	1200 x 900	1190-1210	890-910	598-618	298-318	810	500	3T1517	4T1517	
	900 x 900	890-910	890-910	251-271	251-271	880	550	3T1518	4T1518	2.488,-
	1000 x 1000	990-1010	990-1010	351-371	351-371	880	550	3T1521	4T1521	2.588,-
	900 x 1000	890-910	990-1010	251-271	351-371	880	550	3T1520	4T1520	
1000 x 900	990-1010	890-910	351-371	251-271	880	550	3T1519	4T1519		

Made-to-measure



Height	Width B	CLI	CRE	Entry width	Radius	elegance	pure	Base price
2000	900-1200	210-600	210-600	810	500	3T1580	4T1580	3.234,-
	900-1200	210-600	210-600	880	550	3T1581	4T1581	

Adjustment range = dimensions - 10mm / + 10mm

Slopes and cut-outs

Slopes and cut-outs	Extra charges
 Supplement per slope/cut-out for made-to-measure	170,-

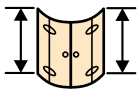
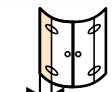
Dim. Range: min. - max.

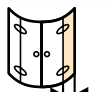
				
2000	210-600	900-1200	900-1200	210-600

Special options

Optional variants	Extra charges
Comfort handle	800
	114,-

Colours - Panel options

Profile colours	Colour code	Extra charges	Panel options	without Anti-Plaque		with Anti-Plaque	
				Glass code	Extra charges	Glass code	Extra charges
White	055	0,-	Clear	321	0,-	322	418,-
Matt silver	087		Sand Plus	315		316	
Silver high-gloss	092		Privatima	373	371,-	375	789,-
			Bubbles	376		377	

HÜPPE Enjoy elegance partially framed Pentagonal

HÜPPE Enjoy pure partially framed Pentagonal

elegance



pure

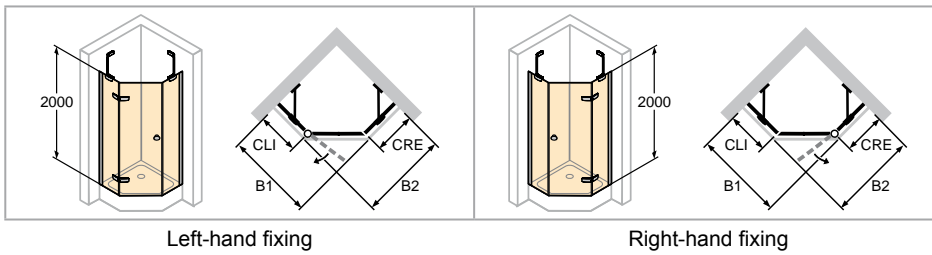

Left-hand fixing

Right-hand fixing

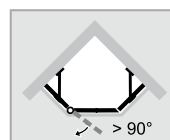
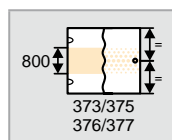
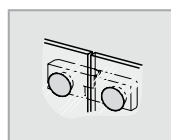
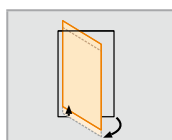
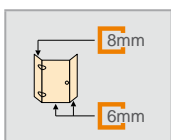
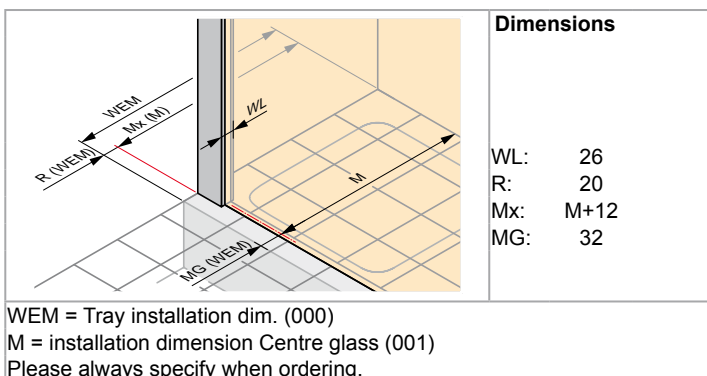

Swing door with fixed segments, 1-panel

Left-hand fixing

Height	Model B1/B2	WEM B1	WEM B2	M (middle of glass) B1/B2	CLI	CRE	Entry width	elegance	pure	Base price
2000	900 x 900	885-905	885-905	853-873/853-873	420-440	412-432	590	3T3601	4T3601	2.488,-
	1000 x 1000	985-1005	985-1005	953-973/953-973	470-490	462-482	665	3T3602	4T3602	2.588,-

Made-to-measure - Left-hand fixing

Height	Model	B1	B2	Entry width	elegance	pure	Base price
1600-2000	900	675-1125	675-1125	590	3T3680	4T3680	3.234,-
	1000	725-1275	725-1275	665	3T3681	4T3681	

Adjustment range = dimensions - 10mm / + 10mm

Right-hand fixing

Height	Model B1/B2	WEM B1	WEM B2	M (middle of glass) B1/B2	CLI	CRE	Entry width	elegance	pure	Base price
2000	900 x 900	885-905	885-905	853-873/853-873	412-432	420-440	590	3T3701	4T3701	2.488,-
	1000 x 1000	985-1005	985-1005	953-973/953-973	462-482	470-490	665	3T3702	4T3702	2.588,-

Made-to-measure - Right-hand fixing

Height	Model	B1	B2	Entry width	elegance	pure	Base price
1600-2000	900	675-1125	675-1125	590	3T3780	4T3780	3.234,-
	1000	725-1275	725-1275	665	3T3781	4T3781	

Adjustment range = dimensions - 10mm / + 10mm

Slopes and cut-outs

Slopes and cut-outs	Extra charges
	Supplement per slope/cut-out for made-to-measure 170,-

Dim. Range: min. - max.

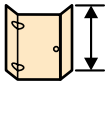
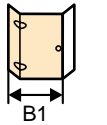
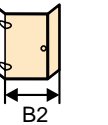
				Model
1600-2000	675-1125	675-1125	412-432	900
1600-2000	725-1275	725-1275	462-482	1000

Special options

Optional variants	Extra charges
Comfort handle	800 57,-

Colours - Panel options

Profile colours	Colour code	Extra charges	Panel options	without Anti-Plaque		with Anti-Plaque	
				Glass code	Extra charges	Glass code	Extra charges
White	055	0,-	Clear	321	371,-	322	418,-
Matt silver	087		Sand Plus	315		316	
Silver high-gloss	092		Privatima	373		375	
			Bubbles	376		377	

HÜPPE Solva pure frameless model overview - Base price

Rectangular

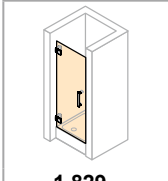
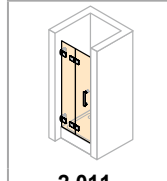
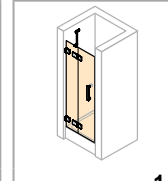
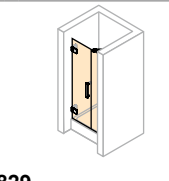
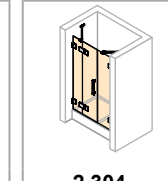
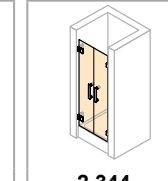
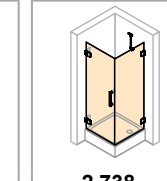
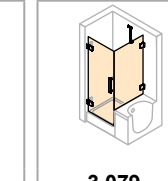
Swing door in recess  1.829,- K.4-K.5	Folding swing door in recess  2.011,- K.6-K.7	Swing door with fixed segment in recess  1.829,- K.8-K.9	Swing door with additional section in recess  1.829,- K.10-K.11	Swing door with fixed segment and additional section in recess  2.304,- K.12-K.13	Two-way door in recess  2.344,- K.14-K.15	Swing door with side panel  2.738,- K.16-K.17	Swing door with shortened side panel  3.079,- K.18-K.19
--	--	---	--	--	---	--	--

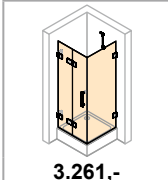
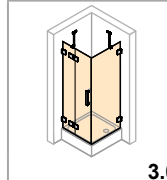
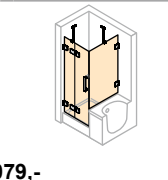
Folding swing door with side panel  3.261,- K.20-K.21	Swing door with fixed segment and side panel  3.079,- K.22-K.23	Swing door with fixed segment and side panel, short  3.079,- K.24-K.25
--	--	---

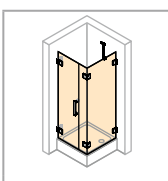
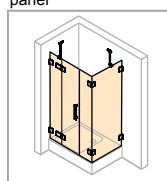
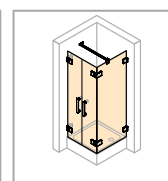
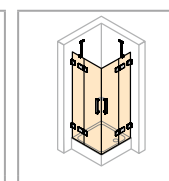
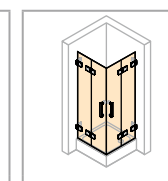
Swing door with additional section and side panel  3.079,- K.26-K.27	Swing door with fixed segment, with additional section and side panel  3.554,- K.28-K.29	Two-way door with side panel  3.282,- K.30-K.31	Swing door corner entry with fixed segments  3.624,- K.32-K.33	Folding swing door corner entry  3.986,- K.34-K.35
--	--	---	--	--

Quadrant

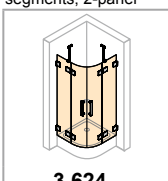
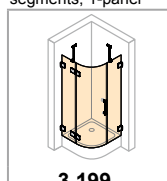
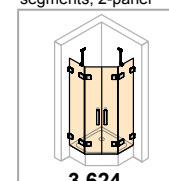
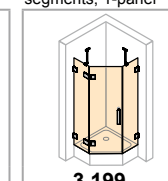
Swing door with fixed segments, 2-panel  3.624,- K.36-K.37	Swing door with fixed segments, 1-panel  3.199,- K.38-K.39	Swing door with fixed segments, 2-panel  3.624,- K.40-K.41	Swing door with fixed segments, 1-panel  3.199,- K.42-K.43
---	---	---	---

Pentagonal

U-shaped enclosure

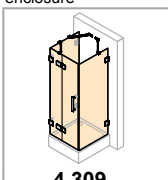
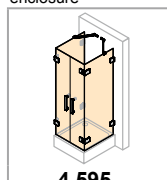
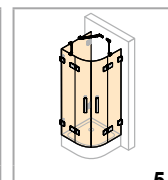
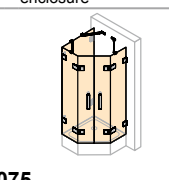
Swing door, rectangular U-shaped enclosure  4.309,- K.44-K.46	Two-way door, rectangular U-shaped enclosure  4.595,- K.47	Swing door, quadrant U-shaped enclosure  5.075,- K.48	Swing door, pentagonal U-shaped enclosure  5.075,- K.49
--	---	--	--

Walk-In

Free standing side panel

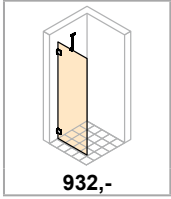

932,-

S.24-S.25

Walk-In side panel with movable segment

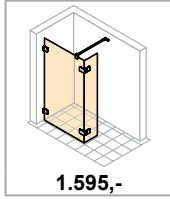

1.595,-

S.26-S.27

Bath-top shower screen

1-panel

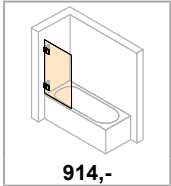

914,-

T.28-T.29

1-panel with fixed segment

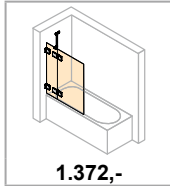

1.372,-

T.30-T.31

Folding swing door

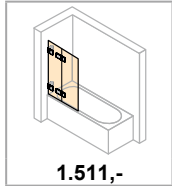

1.511,-

T.32-T.33

HÜPPE Solva pure frameless glass

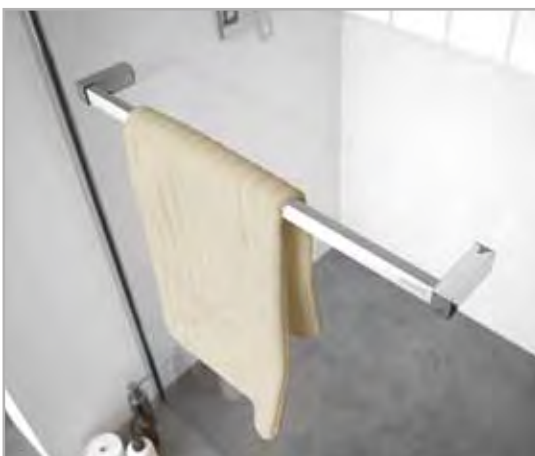

Towel rail in brushed silver for all side panels. If you order the towel rail as a special option, it is screw-fitted to the side panel. For a subsequent installation the towel rail can be ordered as an accessory (bonded installation).



All HÜPPE Solva pure models can be optionally installed with a drip deflector strip for optimum tightness or or without for a barrier free easy entry

Product details



HÜPPE Solva pure is equipped with a high quality handle combination - an attractive bow-shaped handle outside, a knob handle inside for easy cleaning



All folding swing doors of the HÜPPE Solva pure frameless series are fitted with a stylish handle on both sides for maximum pivoting range.



NEW TECHNOLOGY: The rise & fall mechanism - now discreetly hidden behind a cover - gently lifts the door on opening. This spares the lower seals and enables almost automatic closing of the doors



Adjustable glass-glass bracket as standard - easy installation of side panels with walls that are not vertically aligned. You can find suitable movable wall angles in the „Accessory kit“ section



The perfect combination of maximum transparency and optimum water-tightness. A small strip provides increased frameless water-tightness with direct stop hinge



NEW TECHNOLOGY: The new HÜPPE SoftSeal technology now provides maximum water-tightness despite a heavy load on the hinges



The door panels open inwards and outwards thanks to the HÜPPE Solva pure hinges. They can remain on the inside after showering. Ideal for saving space around the shower in small bathrooms and perfect for ventilating the shower area



HÜPPE Solva pure frameless Rectangular

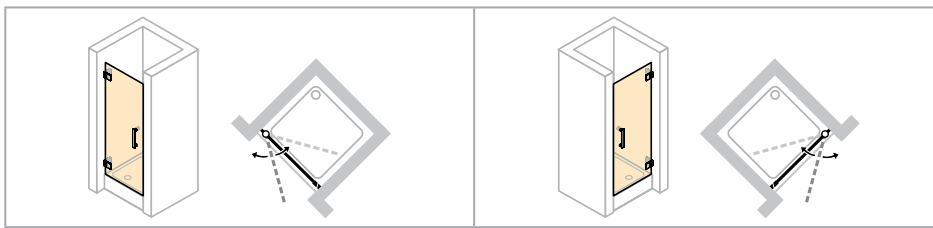

Left-hand fixing

Right-hand fixing

- Measurements must always be taken.

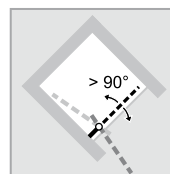
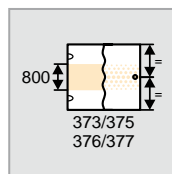
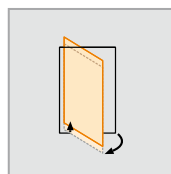
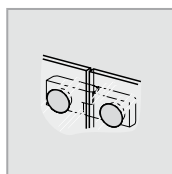
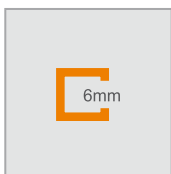

Swing door in recess



Made-to-measure

Height	Width Door front	Left-hand fixing Product no.	Right-hand fixing Product no.	Base price
1200-2000	500-1000	SR2380	SR2480	1.829,-
2001-2200	500-900	SR2381	SR2481	2.376,-

Slopes and cut-outs

Slopes and cut-outs	Extra charges
	Supplement per slope/cut-out for made-to-measure 170,-

Dim. Range: min. - max.

	
1200-2000	500-1000
2001-2200	500-900

Colours - Panel options

Profile colours	Colour code	Extra charges	Panel options	without Anti-Plaque		with Anti-Plaque	
				Glass code	Extra charges	Glass code	Extra charges
Silver high-gloss	092	0,-	Clear	321	0,-	322	209,-
			Grey	301		368	
			Bronze	341		378	
			Sand Plus	315	186,-	316	395,-
			Privatima	373		375	
			Bubbles	376		377	
			Mirror glass	380	439,-	381	648,-

HÜPPE Solva pure frameless Rectangular

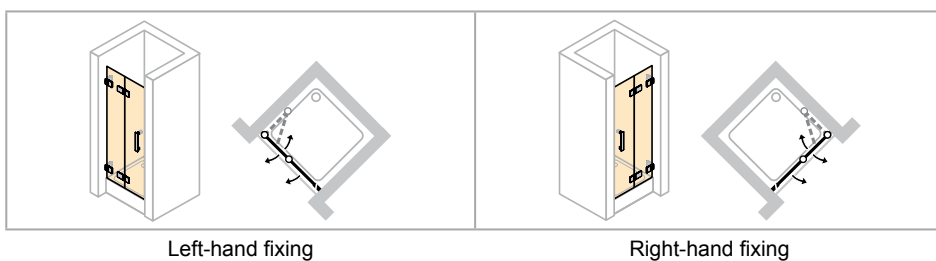

Left-hand fixing

Right-hand fixing

- Measurements must always be taken.
- Mirror glass (380/381): Please state in your order which segment should be produced with mirror glass. If this is not stated, the entire unit will be produced with mirror glass.
- For technical information, see Profile Colours and Panel Options section.

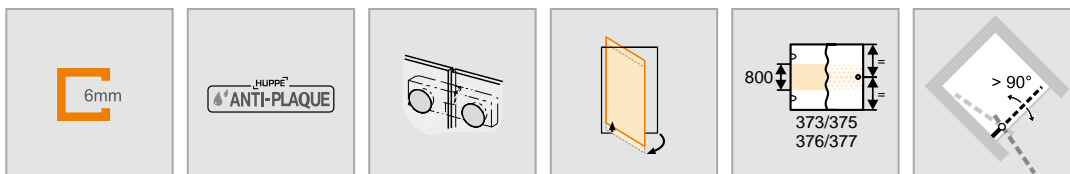

Folding swing door in recess

Made-to-measure

Height	Width Door front	Left-hand fixing Product no.	Right-hand fixing Product no.	Base price
1200-2000	500-1250	SR4380	SR4480	2.011,-

Slopes and cut-outs

Slopes and cut-outs	Extra charges
	Supplement per slope/cut-out for made-to-measure 170,-

Dim. Range: min. - max.

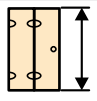
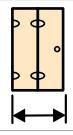
	
1200-2000	500-1250

Colours - Panel options

Profile colours	Colour code	Extra charges	Panel options	without Anti-Plaque		with Anti-Plaque	
				Glass code	Extra charges	Glass code	Extra charges
Silver high-gloss	092	0,-	Clear	321	0,-	322	209,-
			Grey	301		368	
			Bronze	341		378	
			Sand Plus	315	186,-	316	395,-
			Privatima	373		375	
			Bubbles	376		377	
			Mirror glass	380	439,-	381	648,-

HÜPPE Solva pure frameless Rectangular

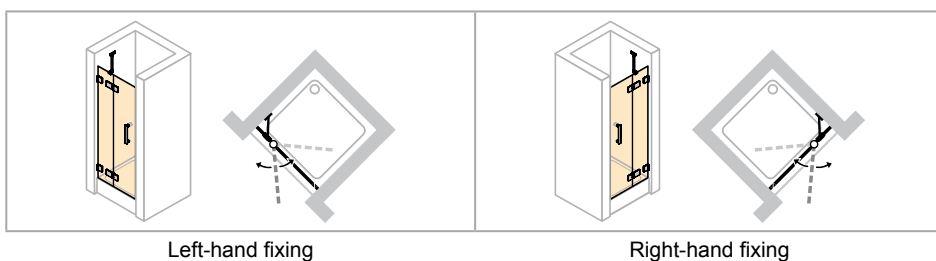

Left-hand fixing

Right-hand fixing

- Measurements must always be taken.
- Mirror glass (380/381): Please state in your order which segment should be produced with mirror glass. If this is not stated, the entire unit will be produced with mirror glass.
- For technical information, see Profile Colours and Panel Options section.

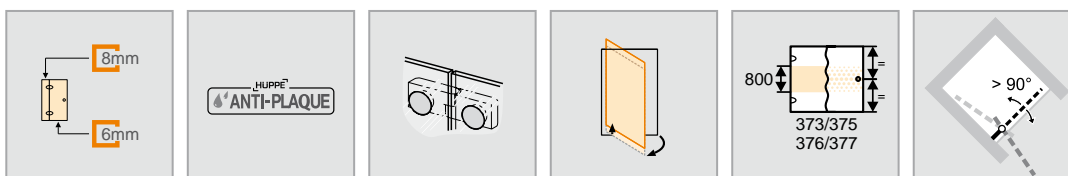

Swing door with fixed segment in recess





Made-to-measure

Height	Width Door front	Left-hand fixing Product no.	Right-hand fixing Product no.	Base price
1200-2000	700-1200	SR0480	SR0580	1.829,-
	1201-1500	SR0482	SR0582	2.485,-
2001-2200	700-1200	SR0481	SR0581	2.376,-
	1201-1500	SR0483	SR0583	3.032,-

Slopes and cut-outs

Slopes and cut-outs	Extra charges
	Supplement per slope/cut-out for made-to-measure 170,-

Dim. Range: min. - max.

			
1200-2200	700-1500	220-600	max. 900

Special options

Optional variants	Extra charges
T-solution brace, complete (solid wall/glass/solid wall) to 2000mm x 150mm	 925 208,-

Colours - Panel options

Profile colours	Colour code	Extra charges	Panel options		without Anti-Plaque		with Anti-Plaque	
			Glass code	Extra charges	Glass code	Extra charges		
Silver high-gloss	092	0,-	Clear	321	0,-	322	209,-	
			Grey	301		368		
			Bronze	341		378		
			Sand Plus	315	186,-	316	395,-	
			Privatima	373		375		
			Bubbles	376		377		
			Mirror glass	380	439,-	381	648,-	

HÜPPE Solva pure frameless Rectangular

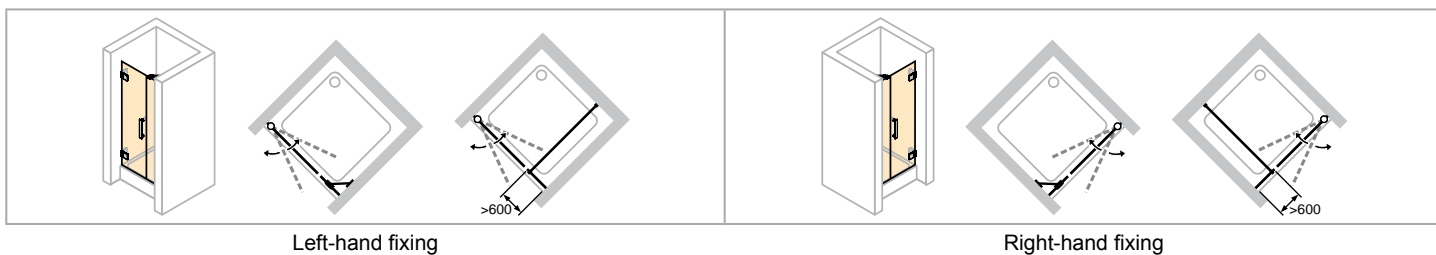

Left-hand fixing

Right-hand fixing

- Measurements must always be taken.
- Mirror glass (380/381): Please state in your order which segment should be produced with mirror glass. If this is not stated, the entire unit will be produced with mirror glass.
- For technical information, see Profile Colours and Panel Options section.

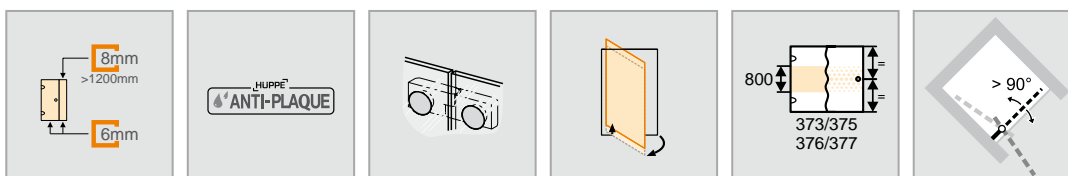

Swing door with additional section in recess

Made-to-measure

Height	Width Door front	Left-hand fixing Product no.	Right-hand fixing Product no.	Base price
1200-2000	700-1200	SR2980	SR3080	1.829,-
	1201-2800	SR2982	SR3082	2.485,-
2001-2200	700-1200	SR2981	SR3081	2.376,-
	1201-2700	SR2983	SR3083	3.032,-

Slopes and cut-outs

Slopes and cut-outs	Extra charges
	Supplement per slope/cut-out for made-to-measure 170,-

Dim. Range: min. - max.

Height	Width	Max. width	Max. depth
1200-2000	700-2800	max. 1000	200-1800
2001-2200	700-2700	max. 900	200-1800

Special options

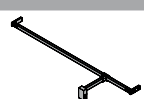
Optional variants	Extra charges
T-solution brace, complete (solid wall/glass/solid wall) to 2000mm x 150mm	 925 208,-

Colours - Panel options

Profile colours	Colour code	Extra charges	Panel options		without Anti-Plaque		with Anti-Plaque	
			Glass code	Extra charges	Glass code	Extra charges		
Silver high-gloss	092	0,-	Clear	321	0,-	322	209,-	
			Grey	301		368		
			Bronze	341	186,-	378	395,-	
			Sand Plus	315		316		
			Privatima	373		375		
			Bubbles	376		377		
			Mirror glass	380	439,-	381	648,-	

HÜPPE Solva pure frameless Rectangular

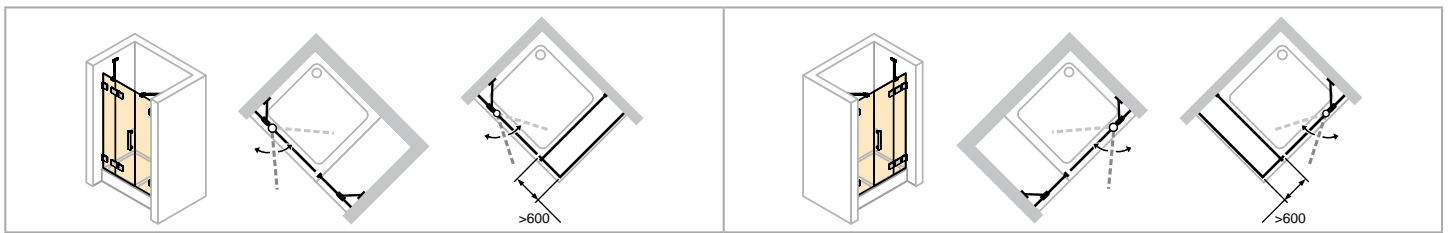

Left-hand fixing

Right-hand fixing

- Measurements must always be taken.
- Mirror glass (380/381): Please state in your order which segment should be produced with mirror glass. If this is not stated, the entire unit will be produced with mirror glass.
- For technical information, see Profile Colours and Panel Options section.

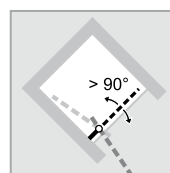
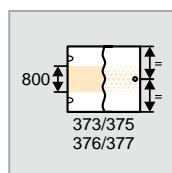
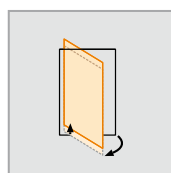
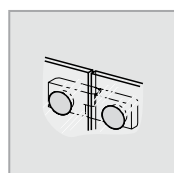
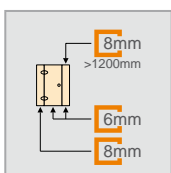

Swing door with fixed segment and additional section in recess

Made-to-measure

Height	Width Door front	Left-hand fixing Product no.	Right-hand fixing Product no.	Base price
1200-2000	1100-1500	SR1480	SR1580	2.304,-
	1501-3300	SR1482	SR1582	2.960,-
2001-2200	1100-1500	SR1481	SR1581	2.851,-
	1501-3300	SR1483	SR1583	3.508,-

Slopes and cut-outs

Slopes and cut-outs	Extra charges
	Supplement per slope/cut-out for made-to-measure 170,-

Dim. Range: min. - max.

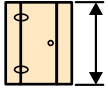
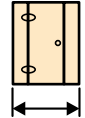
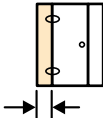
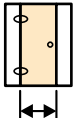
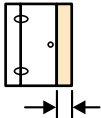
				
1200-2200	1100-3300	220-600	max. 900	200-1800

Special options

Optional variants		Extra charges
F-solution brace, complete (solid wall/glass/glass/solid wall) to 2000mm x 150mm x 150mm		371,-

Colours - Panel options

Profile colours	Colour code	Extra charges	Panel options		without Anti-Plaque		with Anti-Plaque	
					Glass code	Extra charges	Glass code	Extra charges
Silver high-gloss	092	0,-	Clear	321	0,-	322	418,-	
			Grey	301		368		
			Bronze	341	371,-	378	789,-	
			Sand Plus	315		316		
			Privatima	373		375		
			Bubbles	376		377		
			Mirror glass	380	439,-	381	857,-	

HÜPPE Solva pure frameless Rectangular

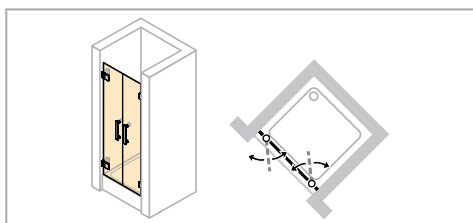

- Measurements must always be taken.
- Mirror glass (380/381): Please state in your order which segment should be produced with mirror glass. If this is not stated, the entire unit will be produced with mirror glass.
- For technical information, see Profile Colours and Panel Options section.

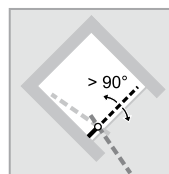
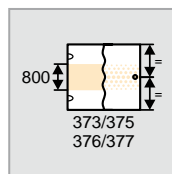
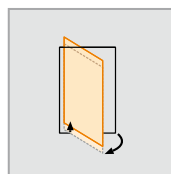
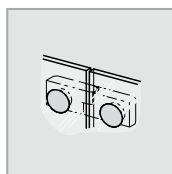
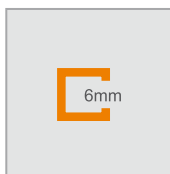



Two-way door in recess

Made-to-measure

Height	Width Door front	Product no.	Base price
1200-2000	600-1200	SR3380	2.344,-
	1201-1800	SR3382	3.002,-
2001-2200	600-1200	SR3381	2.893,-
	1201-1800	SR3383	3.549,-

Dim. Range: min. - max.

	
1200-2200	600-1800

Colours - Panel options

Profile colours	Colour code	Extra charges	Panel options	without Anti-Plaque		with Anti-Plaque	
				Glass code	Extra charges	Glass code	Extra charges
Silver high-gloss	092	0,-	Clear	321	0,-	322	209,-
			Grey	301		368	
			Bronze	341		378	
			Sand Plus	315	186,-	316	395,-
			Privatima	373		375	
			Bubbles	376		377	
			Mirror glass	380	439,-	381	648,-

HÜPPE Solva pure frameless Rectangular

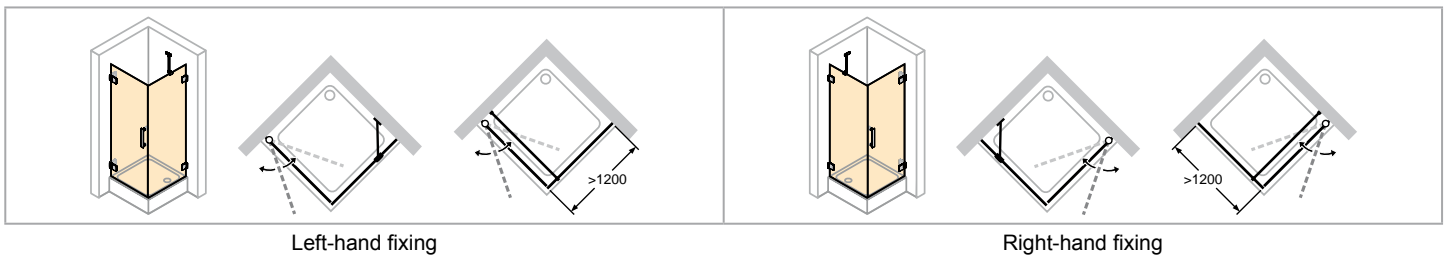

- Measurements must always be taken.
- Mirror glass (380/381): Please state in your order which segment should be produced with mirror glass. If this is not stated, the entire unit will be produced with mirror glass.
- For technical information, see Profile Colours and Panel Options section.
- Towel rail height can be selected individually and must be specified with the order. If nothing is specified, the towel rail is always delivered middle of glass (height and width).
- Installation of towel rail only possible on side panel.

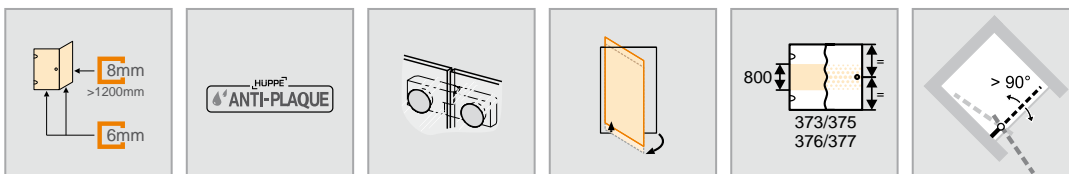

Swing door with side panel

Made-to-measure

Height	Width Door front	Width Side panel	Left-hand fixing Product no.	Right-hand fixing Product no.	Base price
1200-2000	500-1000	200-1200	SR2580	SR2680	2.738,-
	500-1000	1201-1800	SR2582	SR2682	3.395,-
2001-2200	500-900	200-1200	SR2581	SR2681	3.285,-
	500-900	1201-1800	SR2583	SR2683	3.941,-

Slopes and cut-outs

Slopes and cut-outs	Extra charges
	Supplement per slope/cut-out for made-to-measure 170,-

Dim. Range: min. - max.

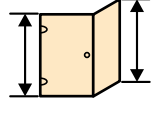
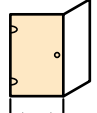
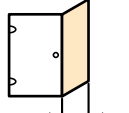
		
1200-2000	500-1000	200-1800
2001-2200	500-900	200-1800

Special options

Optional variants	Extra charges
Towel rail (silver high-gloss)	T99 210,-

Colours - Panel options

Profile colours	Colour code	Extra charges	Panel options		without Anti-Plaque		with Anti-Plaque	
			Glass code	Extra charges	Glass code	Extra charges		
Silver high-gloss	092	0,-	Clear	321	0,-	322	418,-	
			Grey	301		368		
			Bronze	341	371,-	378	789,-	
			Sand Plus	315		316		
			Privatima	373		375		
			Bubbles	376		377		
			Mirror glass	380	439,-	381	857,-	

HÜPPE Solva pure frameless Rectangular

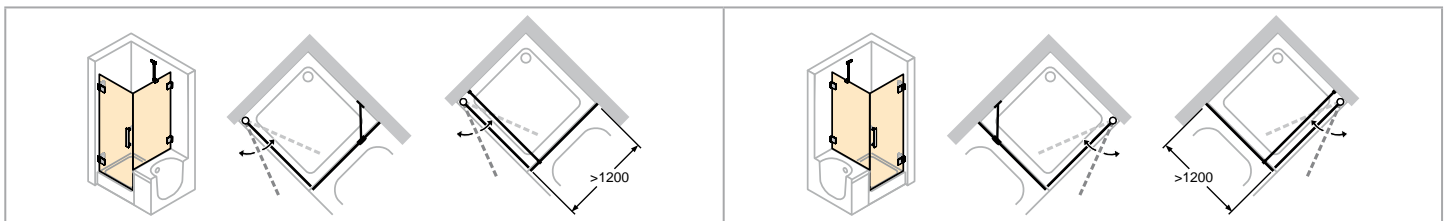

Left-hand fixing

Right-hand fixing

- Measurements must always be taken.
- Mirror glass (380/381): Please state in your order which segment should be produced with mirror glass. If this is not stated, the entire unit will be produced with mirror glass.
- For technical information, see Profile Colours and Panel Options section.
- Towel rail height can be selected individually and must be specified with the order. If nothing is specified, the towel rail is always delivered middle of glass (height and width).
- Installation of towel rail only possible on side panel.

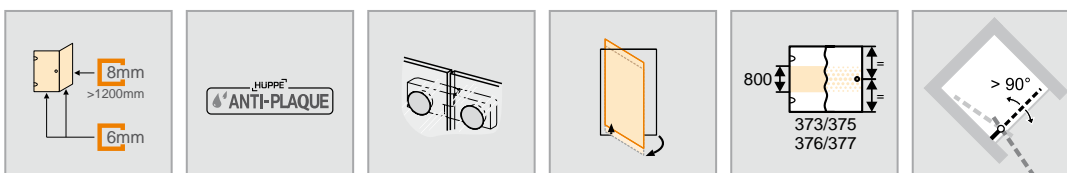

Swing door with shortened side panel

Made-to-measure

Height	Width Door front	Width Side panel	Left-hand fixing Product no.	Right-hand fixing Product no.	Base price
1200-2000	500-1000	200-1200	SR2780	SR2880	3.079,-
	500-1000	1201-1800	SR2782	SR2882	3.735,-
2001-2200	500-900	200-1200	SR2781	SR2881	3.625,-
	500-900	1201-1800	SR2783	SR2883	4.281,-

Slopes and cut-outs

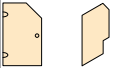
Slopes and cut-outs	Extra charges
	Supplement per slope/cut-out for made-to-measure 170,-

Dim. Range: min. - max.

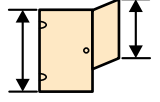
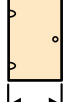
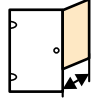
		
1200-2000	500-1000	200-1800
2001-2200	500-900	200-1800

Special options

Optional variants	Extra charges
Towel rail (silver high-gloss)	T99 210,-

Colours - Panel options

Profile colours	Colour code	Extra charges	Panel options	without Anti-Plaque		with Anti-Plaque	
				Glass code	Extra charges	Glass code	Extra charges
Silver high-gloss	092	0,-	Clear	321	0,-	322	418,-
			Grey	301		368	
			Bronze	341		378	
			Sand Plus	315	371,-	316	789,-
			Privatima	373		375	
			Bubbles	376		377	
			Mirror glass	380	439,-	381	857,-

HÜPPE Solva pure frameless Rectangular

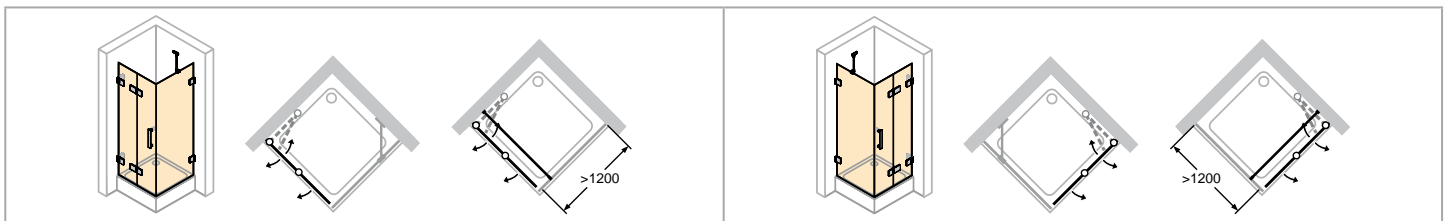

Left-hand fixing

Right-hand fixing

- Measurements must always be taken.
- Mirror glass (380/381): Please state in your order which segment should be produced with mirror glass. If this is not stated, the entire unit will be produced with mirror glass.
- For technical information, see Profile Colours and Panel Options section.
- Towel rail height can be selected individually and must be specified with the order. If nothing is specified, the towel rail is always delivered middle of glass (height and width).
- Installation of towel rail only possible on side panel.

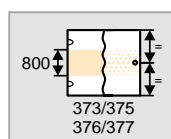
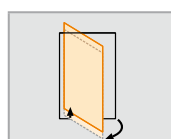
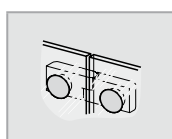
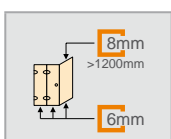

Folding swing door with side panel

Made-to-measure

Height	Width Door front	Width Side panel	Left-hand fixing Product no.	Right-hand fixing Product no.	Base price
1200-2000	500-1250	200-1200	SR4580	SR4680	3.261,-
	500-1250	1201-1800	SR4581	SR4681	3.917,-

Slopes and cut-outs

Slopes and cut-outs	Extra charges
	Supplement per slope/cut-out for made-to-measure 170,-

Dim. Range: min. - max.

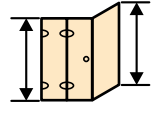
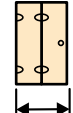
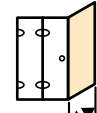
		
1200-2000	500-1250	200-1800

Special options

Optional variants	Extra charges
Towel rail (silver high-gloss)	T99 210,-

Colours - Panel options

Profile colours	Colour code	Extra charges	Panel options		without Anti-Plaque		with Anti-Plaque	
			Glass code	Extra charges	Glass code	Extra charges		
Silver high-gloss	092	0,-	Clear	321	0,-	322	418,-	
			Grey	301		368		
			Bronze	341	371,-	378	789,-	
			Sand Plus	315		316		
			Privatima	373		375		
			Bubbles	376		377		
			Mirror glass	380	439,-	381	857,-	

HÜPPE Solva pure frameless Rectangular

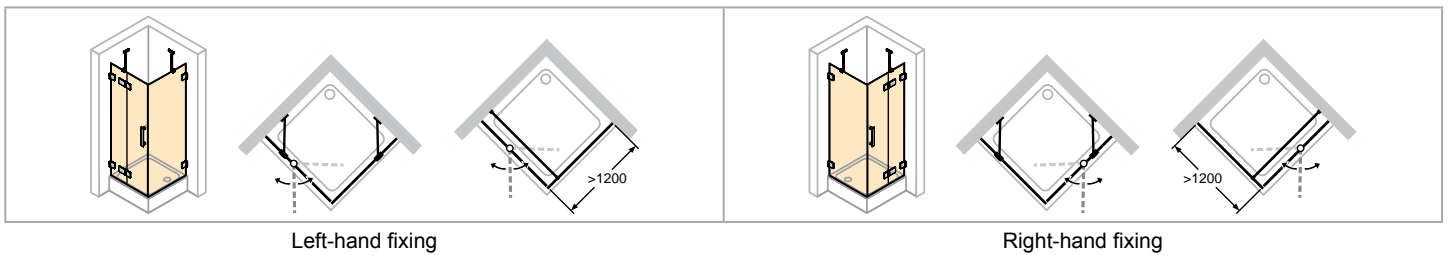

Left-hand fixing

Right-hand fixing

- Measurements must always be taken.
- Mirror glass (380/381): Please state in your order which segment should be produced with mirror glass. If this is not stated, the entire unit will be produced with mirror glass.
- For technical information, see Profile Colours and Panel Options section.
- Towel rail height can be selected individually and must be specified with the order. If nothing is specified, the towel rail is always delivered middle of glass (height and width).
- Installation of towel rail only possible on side panel.

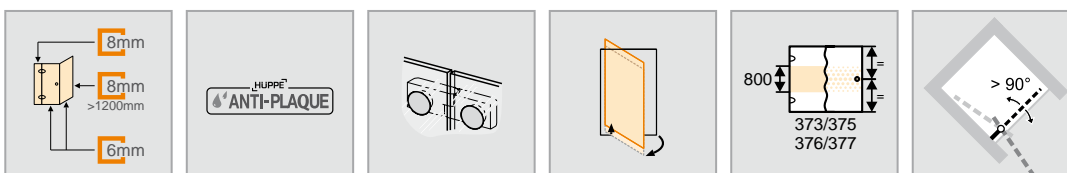

Swing door with fixed segment and side panel

Made-to-measure

Height	Width Door front	Width Side panel	Left-hand fixing Product no.	Right-hand fixing Product no.	Base price
1200-2000	700-1200	200-1200	SR0980	SR1080	3.079,-
	700-1200	1201-1800	SR0982	SR1082	3.735,-
	1201-1500 1201-1500	200-1200 1201-1800			
2001-2200	700-1200	200-1200	SR0981	SR1081	3.625,-
	700-1200	1201-1800	SR0983	SR1083	4.281,-
	1201-1500 1201-1500	200-1200 1201-1800			

Slopes and cut-outs

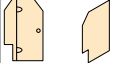
Slopes and cut-outs	Extra charges
	Supplement per slope/cut-out for made-to-measure 170,-

Dim. Range: min. - max.

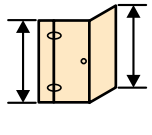
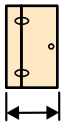
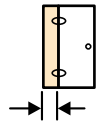
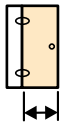
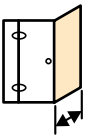
				
1200-2200	700-1500	220-600	max. 900	200-1800

Special options

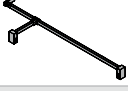
Optional variants	Extra charges
T-solution brace, complete (solid wall/glass/glass) to 2000mm x 150mm	 927 148,-
Towel rail (silver high-gloss)	T99 210,-
Towel rail and T-solution stabilizer, complete (solid wall/glass/glass) up to 2000mm x 150mm	T27 358,-

Colours - Panel options

Profile colours	Colour code	Extra charges	Panel options		without Anti-Plaque		with Anti-Plaque	
			Glass code	Extra charges	Glass code	Extra charges		
Silver high-gloss	092	0,-	Clear	321	0,-	322	418,-	
			Grey	301		368		
			Bronze	341	371,-	378	789,-	
			Sand Plus	315		316		
			Privatima	373		375		
			Bubbles	376		377		
			Mirror glass	380	439,-	381	857,-	

HÜPPE Solva pure frameless Rectangular

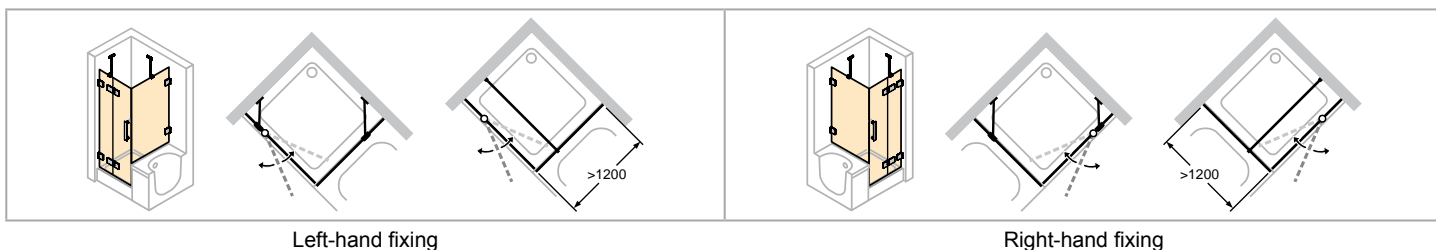

Left-hand fixing

Right-hand fixing

- Measurements must always be taken.
- Mirror glass (380/381): Please state in your order which segment should be produced with mirror glass. If this is not stated, the entire unit will be produced with mirror glass.
- For technical information, see Profile Colours and Panel Options section.
- Towel rail height can be selected individually and must be specified with the order. If nothing is specified, the towel rail is always delivered middle of glass (height and width).
- Installation of towel rail only possible on side panel.

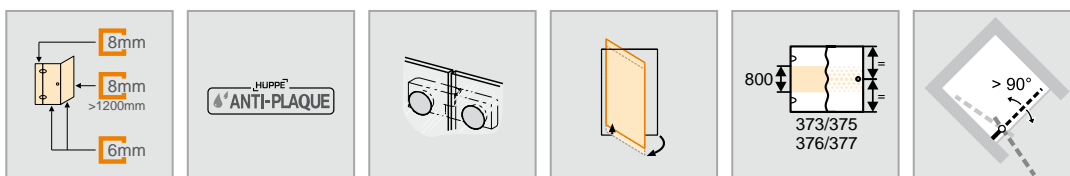

Swing door with fixed segment and side panel, short

Made-to-measure

Height	Width Door front	Width Side panel	Left-hand fixing Product no.	Right-hand fixing Product no.	Base price
1200-2000	700-1200	200-1200	SR1280	SR1380	3.079,-
	700-1200	1201-1800	SR1282	SR1382	3.735,-
	1201-1500 1201-1500	200-1200 1201-1800			
2001-2200	700-1200	200-1200	SR1281	SR1381	3.625,-
	700-1200	1201-1800	SR1283	SR1383	4.281,-
	1201-1500 1201-1500	200-1200 1201-1800			

Slopes and cut-outs

Slopes and cut-outs	Extra charges
	Supplement per slope/cut-out for made-to-measure 170,-

Dim. Range: min. - max.

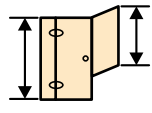
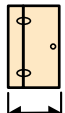
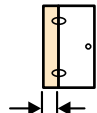
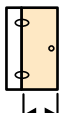
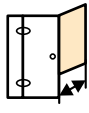
				
1200-2200	700-1500	220-600	max. 900	200-1800

Special options

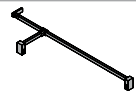
Optional variants	Extra charges
T-solution brace, complete (solid wall/glass/glass) to 2000mm x 150mm	 927 148,-
Towel rail (silver high-gloss)	T99 210,-
Towel rail and T-solution stabilizer, complete (solid wall/glass/glass) up to 2000mm x 150mm	T27 358,-

Colours - Panel options

Profile colours	Colour code	Extra charges	Panel options		without Anti-Plaque		with Anti-Plaque	
			Glass code	Extra charges	Glass code	Extra charges		
Silver high-gloss	092	0,-	Clear	321	0,-	322	418,-	
			Grey	301		368		
			Bronze	341	371,-	378	789,-	
			Sand Plus	315		316		
			Privatima	373		375		
			Bubbles	376		377		
			Mirror glass	380	439,-	381	857,-	

HÜPPE Solva pure frameless Rectangular

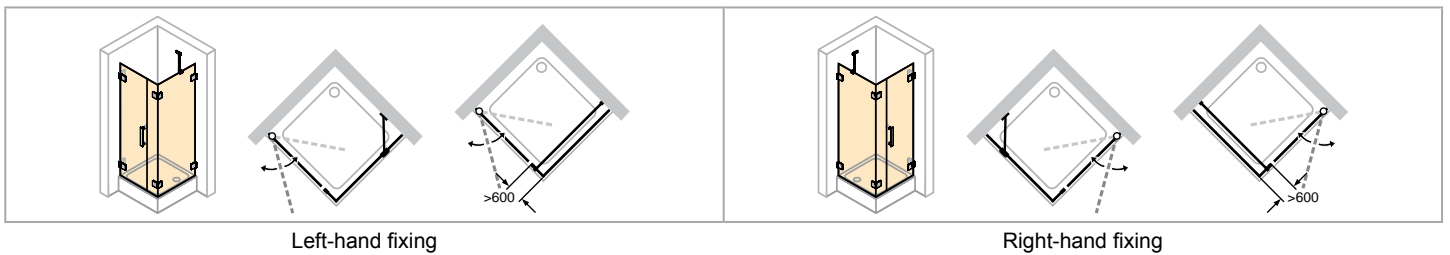

- Measurements must always be taken.
- Mirror glass (380/381): Please state in your order which segment should be produced with mirror glass. If this is not stated, the entire unit will be produced with mirror glass.
- For technical information, see Profile Colours and Panel Options section.
- Towel rail height can be selected individually and must be specified with the order. If nothing is specified, the towel rail is always delivered middle of glass (height and width).
- Installation of towel rail only possible on side panel.

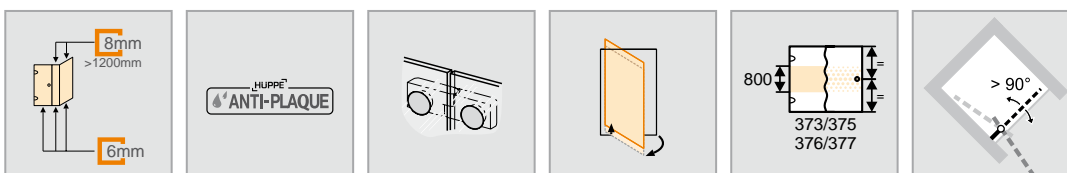

Swing door with additional section and side panel

Made-to-measure

Height	Width Door front	Width Side panel	Left-hand fixing Product no.	Right-hand fixing Product no.	Base price
1200-2000	700-1200	200-1200	SR3180	SR3280	3.079,-
	700-1200	1201-1800	SR3182	SR3282	3.735,-
	1201-2800	200-1200			
2001-2200	700-1200	200-1200	SR3181	SR3281	3.625,-
	700-1200	1201-1800	SR3183	SR3283	4.281,-
	1201-2700	200-1200			
	1201-2700	1201-1800			

Slopes and cut-outs

Slopes and cut-outs	Extra charges
	Supplement per slope/cut-out for made-to-measure 170,-

Dim. Range: min. - max.

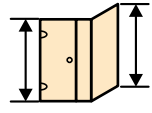
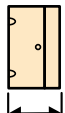
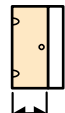
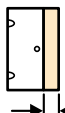
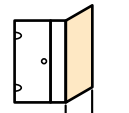
				
1200-2000	700-2800	max. 1000	200-1800	200-1800
2001-2200	700-2700	max. 900	200-1800	200-1800

Special options

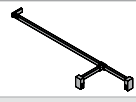
Optional variants	Extra charges
T-solution brace, complete (solid wall/glass/glass) to 2000mm x 150mm	 927 148,-
Towel rail (silver high-gloss)	T99 210,-
Towel rail and T-solution stabilizer, complete (solid wall/glass/glass) up to 2000mm x 150mm	T27 358,-

Colours - Panel options

Profile colours	Colour code	Extra charges	Panel options		without Anti-Plaque		with Anti-Plaque	
			Glass code	Extra charges	Glass code	Extra charges		
Silver high-gloss	092	0,-	Clear	321	0,-	322	418,-	
			Grey	301		368		
			Bronze	341	371,-	378	789,-	
			Sand Plus	315		316		
			Privatima	373		375		
			Bubbles	376		377		
			Mirror glass	380	439,-	381	857,-	

HÜPPE Solva pure frameless Rectangular

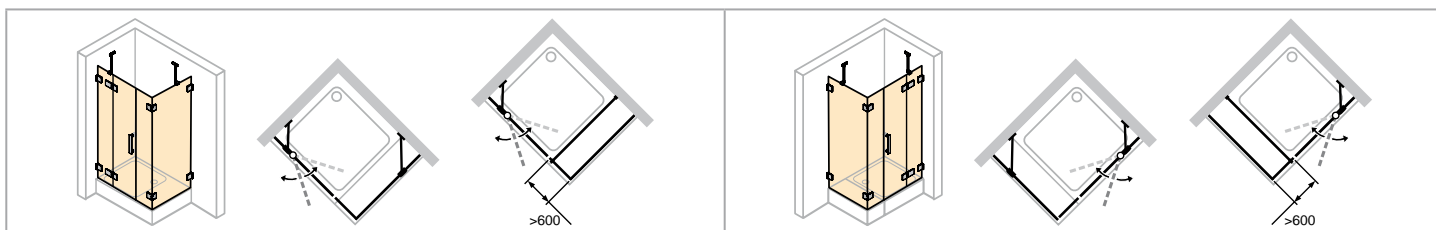

Left-hand fixing

Right-hand fixing

- Measurements must always be taken.
- Mirror glass (380/381): Please state in your order which segment should be produced with mirror glass. If this is not stated, the entire unit will be produced with mirror glass.
- For technical information, see Profile Colours and Panel Options section.
- Towel rail height can be selected individually and must be specified with the order. If nothing is specified, the towel rail is always delivered middle of glass (height and width).
- Installation of towel rail only possible on side panel.

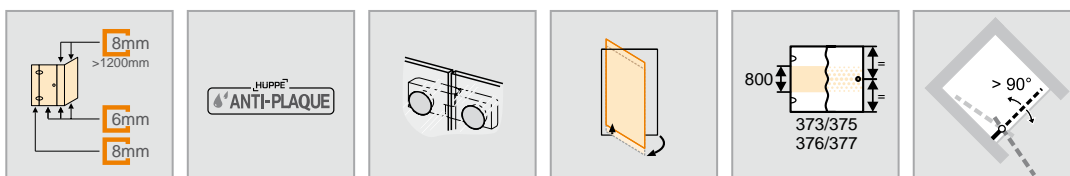

Swing door with fixed segment, with additional section and side panel

Made-to-measure

Height	Width Door front	Width Side panel	Left-hand fixing Product no.	Right-hand fixing Product no.	Base price
1200-2000	900-1200	200-1200	SR1680	SR1780	3.554,-
	900-1200	1201-1800	SR1682	SR1782	4.211,-
	1201-3300	200-1200			
2001-2200	1201-3300	1201-1800	SR1681	SR1781	4.101,-
	900-1200	200-1200	SR1683	SR1783	4.757,-
	1201-3300	1201-1800			

Slopes and cut-outs

Slopes and cut-outs	Extra charges
	Supplement per slope/cut-out for made-to-measure 170,-

Dim. Range: min. - max.

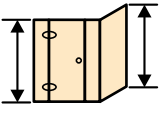
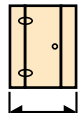
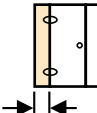
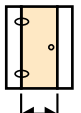
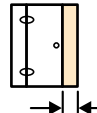
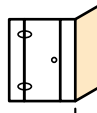
					
1200-2200	900-3300	220-600	max. 900	200-1800	200-1800

Special options

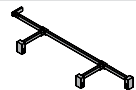
Optional variants		Extra charges
F-solution stabilizer, complete (solid wall/glass/glass/glass) up to 2000mm x 150mm x 150mm		928 312,-
Towel rail (silver high-gloss)		T99 210,-
Towel rail and F-solution stabilizer, complete (solid wall/glass/glass/glass) up to 2000mm x 150mm x 150mm		T28 522,-

Colours - Panel options

Profile colours	Colour code	Extra charges	Panel options		without Anti-Plaque		with Anti-Plaque	
			Glass code	Extra charges	Glass code	Extra charges		
Silver high-gloss	092	0,-	Clear	321	0,-	322	418,-	
			Grey	301		368		
			Bronze	341	371,-	378	789,-	
			Sand Plus	315		316		
			Privatima	373		375		
			Bubbles	376		377		
			Mirror glass	380	439,-	381	857,-	

HÜPPE Solva pure frameless Rectangular

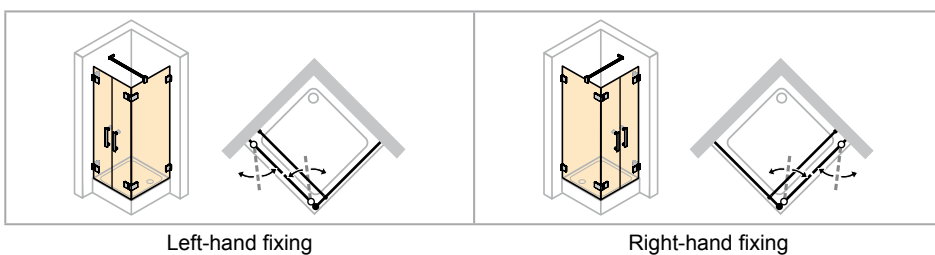

Left-hand fixing

Right-hand fixing

- Measurements must always be taken.
- Mirror glass (380/381): Please state in your order which segment should be produced with mirror glass. If this is not stated, the entire unit will be produced with mirror glass.
- For technical information, see Profile Colours and Panel Options section.
- Towel rail height can be selected individually and must be specified with the order. If nothing is specified, the towel rail is always delivered middle of glass (height and width).
- Installation of towel rail only possible on side panel.

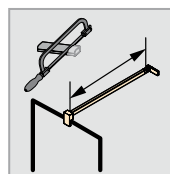
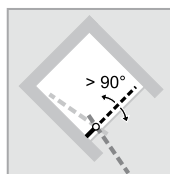
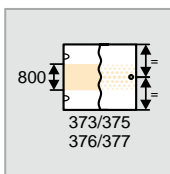
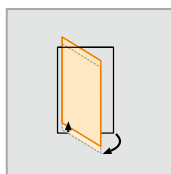
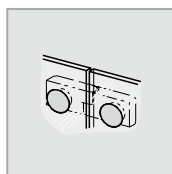
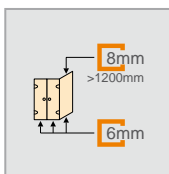

Two-way door with side panel

Made-to-measure

Height	Width Door front	Width Side panel	Left-hand fixing Product no.	Right-hand fixing Product no.	Base price
1200-2000	600-1200	200-1200	SR4180	SR4280	3.282,-
	600-1200	1201-1800	SR4182	SR4282	3.938,-
2001-2200	600-1200	200-1200	SR4181	SR4281	3.828,-
	600-1200	1201-1800	SR4183	SR4283	4.485,-

Slopes and cut-outs

Slopes and cut-outs	Extra charges
	Supplement per slope/cut-out for made-to-measure 170,-

Dim. Range: min. - max.

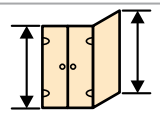
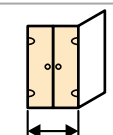
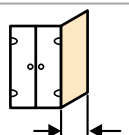
		
1200-2200	600-1200	200-1800

Special options

Special options	Extra charges
Towel rail (silver high-gloss)	T99 210,-

Colours - Panel options

Profile colours	Colour code	Extra charges	Panel options		without Anti-Plaque		with Anti-Plaque	
			Glass code	Extra charges	Glass code	Extra charges		
Silver high-gloss	092	0,-	Clear	321	0,-	322	418,-	
			Grey	301		368		
			Bronze	341	371,-	378	789,-	
			Sand Plus	315		316		
			Privatima	373		375		
			Bubbles	376		377		
			Mirror glass	380	439,-	381	857,-	

HÜPPE Solva pure frameless Rectangular

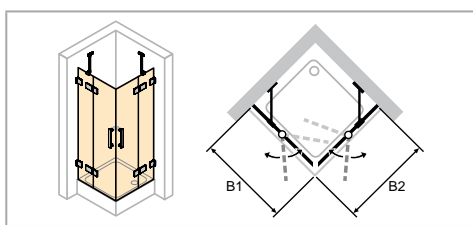

- Measurements must always be taken.
- Mirror glass (380/381): Please state in your order which segment should be produced with mirror glass. If this is not stated, the entire unit will be produced with mirror glass.
- For technical information, see Profile Colours and Panel Options section.

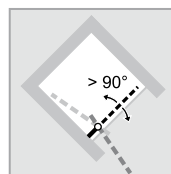
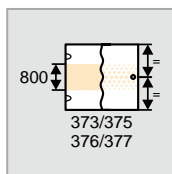
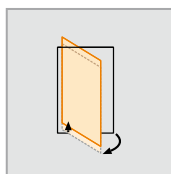
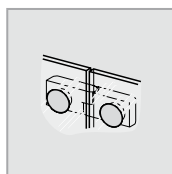
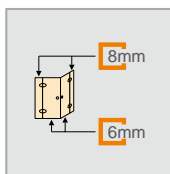

Swing door corner entry with fixed segments

Made-to-measure

Height	Width B1	Width B2	Product no.	Base price
1200-2000	700-1200	700-1200	SR1180	3.624,-
	700-1200	1201-1500	SR1182	4.280,-
	1201-1500	1201-1500		
2001-2200	700-1200	700-1200	SR1181	4.171,-
	700-1200	1201-1500	SR1183	4.828,-
	1201-1500	1201-1500		

Slopes and cut-outs

Slopes and cut-outs	Extra charges
	Supplement per slope/cut-out for made-to-measure 170,-

Dim. Range: min. - max.

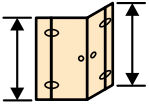
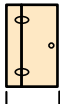
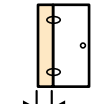
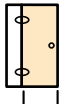
			
1200-2200	700-1500	220-600	max. 900

Colours - Panel options

Profile colours	Colour code	Extra charges	Panel options	without Anti-Plaque		with Anti-Plaque	
				Glass code	Extra charges	Glass code	Extra charges
Silver high-gloss	092	0,-	Clear	321	0,-	322	418,-
			Grey	301		368	
			Bronze	341		378	
			Sand Plus	315	371,-	316	789,-
			Privatima	373		375	
			Bubbles	376		377	
			Mirror glass	380	439,-	381	857,-

HÜPPE Solva pure frameless Rectangular

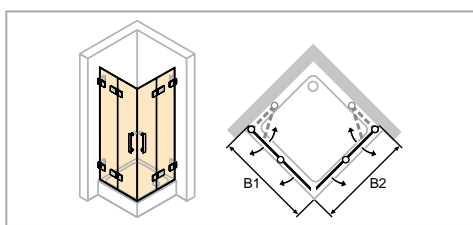

- Measurements must always be taken.
- Mirror glass (380/381): Please state in your order which segment should be produced with mirror glass.
If this is not stated, the entire unit will be produced with mirror glass.
- For technical information, see Profile Colours and Panel Options section.

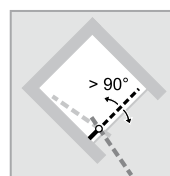
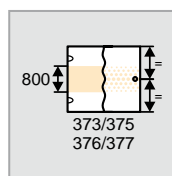
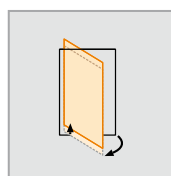
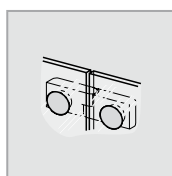
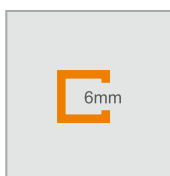

Folding swing door corner entry

Made-to-measure

Height	Width B1	Width B2	Product no.	Base price
1200-2000	500-1250	500-1250	SR4780	3.986,-

Slopes and cut-outs

Slopes and cut-outs	Extra charges
	Supplement per slope/cut-out for made-to-measure 170,-

Dim. Range: min. - max.

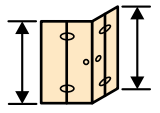
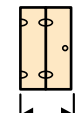
	
1200-2000	500-1250

Colours - Panel options

Profile colours	Colour code	Extra charges	Panel options	without Anti-Plaque		with Anti-Plaque	
				Glass code	Extra charges	Glass code	Extra charges
Silver high-gloss	092	0,-	Clear	321	0,-	322	418,-
			Grey	301		368	
			Bronze	341		378	
			Sand Plus	315	371,-	316	789,-
			Privatima	373		375	
			Bubbles	376		377	
			Mirror glass	380	439,-	381	857,-

HÜPPE Solva pure frameless Quadrant

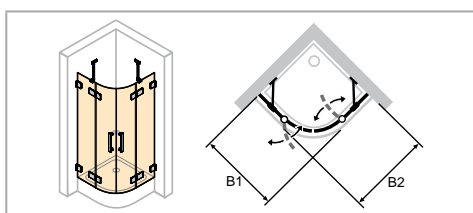

- Measurements must always be taken.

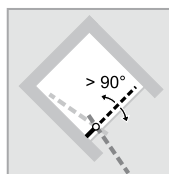
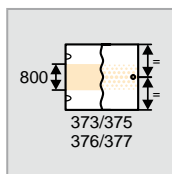
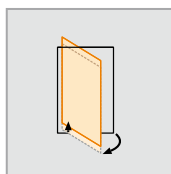
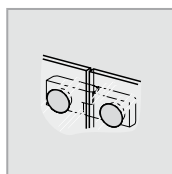
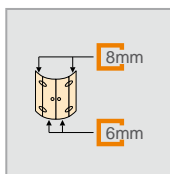

Swing door with fixed segments, 2-panel



Made-to-measure

Height	Width B1	Width B2	Radius	Product no.	Base price
2000	900-1200	900-1200	500	SR1880	3.624,-
	900-1200	900-1200	550	SR1881	

Slopes and cut-outs

Slopes and cut-outs	Extra charges
	Supplement per slope/cut-out for made-to-measure 170,-

Dim. Range: min. - max.

		
2000	900-1200	900-1200

Colours - Panel options

Profile colours	Colour code	Extra charges	Panel options	
			without Anti-Plaque Glass code	with Anti-Plaque Glass code
Silver high-gloss	092	0,-	Clear 321	322
			Privatima 373	375
			Bubbles 376	377
				418,-
				789,-

HÜPPE Solva pure frameless Quadrant

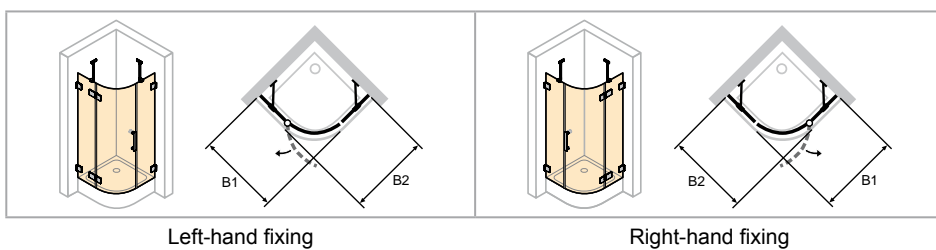

- Measurements must always be taken.
- The fixed segments on the door side are installed with a tilt of 5mm (at the top) towards the outside.

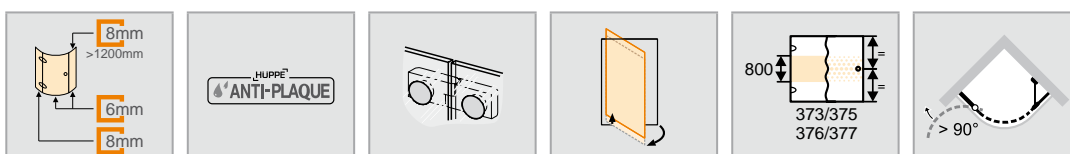

Swing door with fixed segments, 1-panel



Made-to-measure

Height	Width B1	Width B2	Radius	Left-hand fixing Product no.	Right-hand fixing Product no.	Base price
2000	900-1200	900-1200	500	SR1980	SR2080	3.199,-
	900-1200	1201-2300	500	SR1981	SR2081	3.855,-
	900-1200	900-1200	550	SR1982	SR2082	3.199,-
	900-1200	1201-2300	550	SR1983	SR2083	3.855,-

Slopes and cut-outs

Slopes and cut-outs	Extra charges
	Supplement per slope/cut-out for made-to-measure 170,-

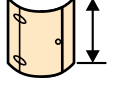
Dim. Range: min. - max.

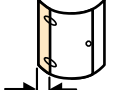
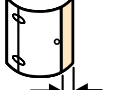
				
2000	900-1200	900-2300	220-600	200-1800

Colours - Panel options

Profile colours	Colour code	Extra charges	Panel options	without Anti-Plaque		with Anti-Plaque	
				Glass code	Extra charges	Glass code	Extra charges
Silver high-gloss	092	0,-	Clear	321	0,-	322	418,-
			Privatima	373	371,-	375	789,-
			Bubbles	376		377	

HÜPPE Solva pure frameless Pentagonal

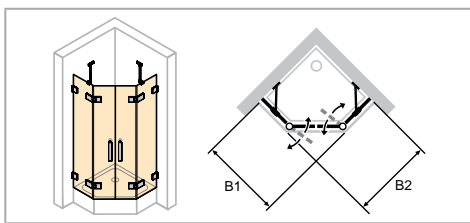

- Measurements must always be taken.

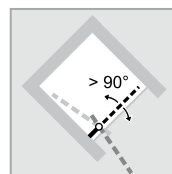
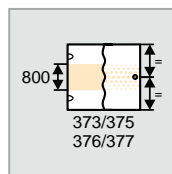
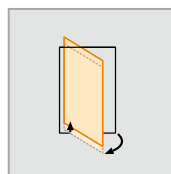
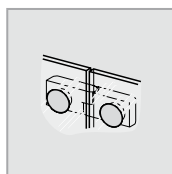
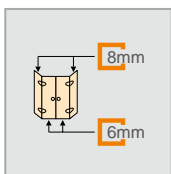

Swing door with fixed segments, 2-panel



Made-to-measure

Height	Width B1	Width B2	Product no.	Base price
1200-2000	700-1200	700-1200	SR4080	3.624,-
	700-1200	1201-1870	SR4082	4.280,-
	1201-1870	700-1200		
	1201-1870	1201-1870		
2001-2200	700-1200	700-1200	SR4081	4.171,-
	700-1200	1201-1870	SR4083	4.828,-
	1201-1870	700-1200		
	1201-1870	1201-1870		

Slopes and cut-outs

Slopes and cut-outs	Extra charges
	Supplement per slope/cut-out for made-to-measure 170,-

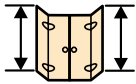
Dim. Range: min. - max.

		
1200-2200	700-1870	700-1870

Colours - Panel options

Profile colours	Colour code	Extra charges	Panel options		without Anti-Plaque		with Anti-Plaque	
			Glass code	Extra charges	Glass code	Extra charges		
Silver high-gloss	092	0,-	Clear	321	0,-	322	418,-	
			Sand Plus	315	371,-	316	789,-	
			Privatima	373		375		
			Bubbles	376		377		

HÜPPE Solva pure frameless Pentagonal

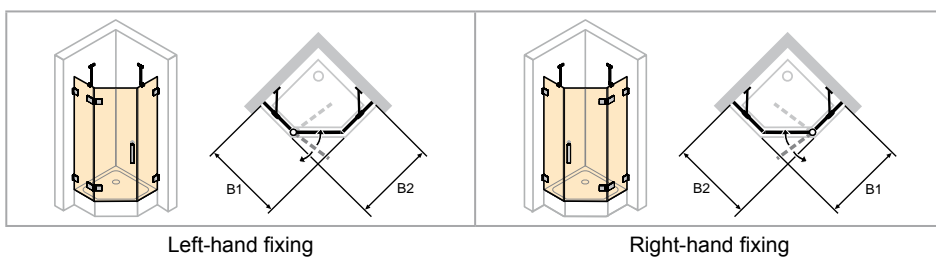

- Measurements must always be taken.

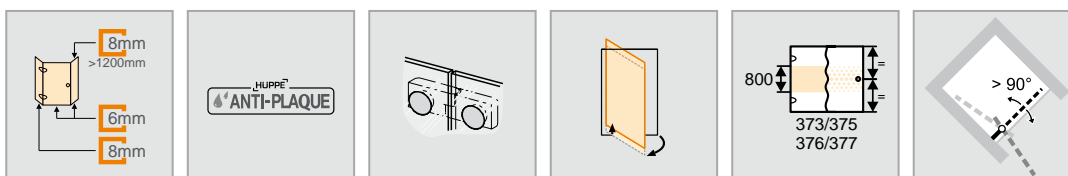

Swing door with fixed segments, 1-panel



Made-to-measure

Height	Width B1	Width B2	Left-hand fixing Product no.	Right-hand fixing Product no.	Base price
1200-2000	700-1200	700-1200	SR3880	SR3980	3.199,-
	700-1200	1201-2430	SR3882	SR3982	3.855,-
	1201-1230	700-1200			
2001-2200	1201-1230	1201-2430	SR3881	SR3981	3.745,-
	700-1200	700-1200	SR3883	SR3983	4.402,-
	700-1200	1201-2430			
	1201-1230	700-1200			

Slopes and cut-outs

Slopes and cut-outs	Extra charges
	Supplement per slope/cut-out for made-to-measure 170,-

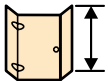
Dim. Range: min. - max.

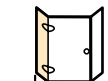
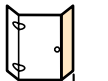
				
1200-2200	700-1230	700-2430	220-600	200-1800

Colours - Panel options

Profile colours	Colour code	Extra charges	Panel options	without Anti-Plaque		with Anti-Plaque	
				Glass code	Extra charges	Glass code	Extra charges
Silver high-gloss	092	0,-	Clear	321	0,-	322	418,-
			Sand Plus	315		316	
			Privatima	373	371,-	375	789,-
			Bubbles	376		377	

HÜPPE Solva pure frameless Rectangular

Swing door, rectangular U-shaped enclosure

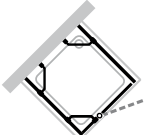
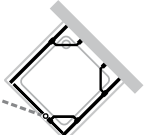
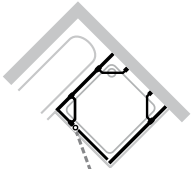
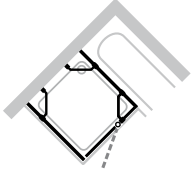
Height	Width	Consisting of:	For ...	Product no.	Price
1200-2000 1200-2000	700-1200 200-1200	1 swing door with fixed segment, left 2 side panels		SR8080	4.309,-
1200-2000 1200-2000	700-1200 200-1200	1 swing door with fixed segment, right 2 side panels		SR8081	4.309,-
1200-2000 1200-2000 1200-2000	700-1200 200-1200 200-1200	1 swing door with fixed segment, left 1 side panel, right 1 shortened side panel, left		SR8082	4.309,-
1200-2000 1200-2000 1200-2000	700-1200 200-1200 200-1200	1 swing door with fixed segment, right 1 side panel, left 1 shortened side panel, right		SR8083	4.309,-

Measurements must always be taken.

Colours - Panel options

Profile colours	Colour code	Extra charges
Silver high-gloss	092	0,-

Panel options	without Anti-Plaque		with Anti-Plaque	
	Glass code	Extra charges	Glass code	Extra charges
Clear	321	0,-	322	418,-
Grey	301		368	
Bronze	341		378	
Sand Plus	315	371,-	316	789,-
Privatima	373		375	
Bubbles	376		377	
Mirror glass	380	439,-	381	857,-

HÜPPE Solva pure frameless Rectangular

Swing door, rectangular U-shaped enclosure

Height	Width	Consisting of:	For ...	Product no.	Price
1200-2000	700-1200	1 swing door with fixed segment, left		SR8280	4.618,-
1200-2000	200-1200	1 side panel, left			
1200-2000	500-1250	1 folding swing door, right			
1200-2000	700-1200	1 swing door with fixed segment, right		SR8281	4.618,-
1200-2000	200-1200	1 side panel, right			
1200-2000	500-1250	1 folding swing door, left			
1200-2000	700-1200	1 swing door with fixed segment, left		SR8282	4.618,-
1200-2000	200-1200	1 shortened side panel, left			
1200-2000	500-1250	1 folding swing door, right			
1200-2000	700-1200	1 swing door with fixed segment, right		SR8283	4.618,-
1200-2000	200-1200	1 shortened side panel, right			
1200-2000	500-1250	1 folding swing door, left			
1200-2200	700-1500	1 Swing door corner entry with fixed segments		SR8380	5.075,-
1200-2000	200-1200	1 side panel			



Measurements must always be taken.

Colours - Panel options

Profile colours	Colour code	Extra charges	Panel options	without Anti-Plaque		with Anti-Plaque	
				Glass code	Extra charges	Glass code	Extra charges
Silver high-gloss	092	0,-	Clear	321	0,-	322	418,-
			Grey	301		368	
			Bronze	341		378	
			Sand Plus	315	371,-	316	789,-
			Privatima	373		375	
			Bubbles	376		377	
			Mirror glass	380	439,-	381	857,-

HÜPPE Solva pure frameless Rectangular

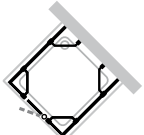
Swing door, rectangular U-shaped enclosure

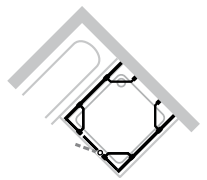
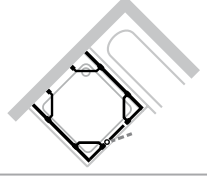
Height	Width	Consisting of:	For ...	Product no.	Price
1200-2000	900-3300	1 Swing door with fixed segment and additional section, right		SR8580	4.975,-
1200-2000	200-1200	1 side panel, left			
1200-2000	200-1200	1 side panel, right			
1200-2000	900-3300	1 Swing door with fixed segment and additional section, left		SR8581	4.975,-
1200-2000	200-1200	1 side panel, left			
1200-2000	200-1200	1 side panel, right			
1200-2000	900-3300	1 Swing door with fixed segment and additional section, right		SR8582	4.975,-
1200-2000	200-1200	1 shortened side panel, left			
1200-2000	200-1200	1 side panel, right			
1200-2000	900-3300	1 Swing door with fixed segment and additional section, left		SR8583	4.975,-
1200-2000	200-1200	1 side panel, left			
1200-2000	200-1200	1 shortened side panel, right			

Measurements must always be taken.

Colours - Panel options

Profile colours	Colour code	Extra charges
Silver high-gloss	092	0,-

Panel options	without Anti-Plaque		with Anti-Plaque	
	Glass code	Extra charges	Glass code	Extra charges
Clear	321	0,-	322	418,-
Grey	301		368	
Bronze	341		378	
Sand Plus	315	371,-	316	789,-
Privatima	373		375	
Bubbles	376		377	
Mirror glass	380	439,-	381	857,-

Two-way door, rectangular U-shaped enclosure

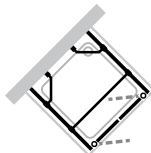
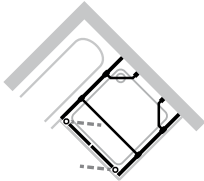
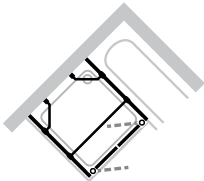
Height	Width	Consisting of:	For ...	Product no.	Price
1200-2000 1200-2000	600-1200 200-1200	1 two-way door 2 side panels		SR8480	4.595,-
1200-2000 1200-2000 1200-2000	600-1200 200-1200 200-1200	1 two-way door 1 side panel, right 1 shortened side panel, left		SR8481	4.595,-
1200-2000 1200-2000 1200-2000	600-1200 200-1200 200-1200	1 two-way door 1 side panel, left 1 shortened side panel, right		SR8482	4.595,-

Measurements must always be taken.



Colours - Panel options

Profile colours	Colour code	Extra charges
Silver high-gloss	092	0,-

Panel options	without Anti-Plaque		with Anti-Plaque	
	Glass code	Extra charges	Glass code	Extra charges
Clear	321	0,-	322	418,-
Grey	301		368	
Bronze	341		378	
Sand Plus	315	371,-	316	789,-
Privatima	373		375	
Bubbles	376		377	
Mirror glass	380	439,-	381	857,-

HÜPPE Solva pure frameless Quadrant

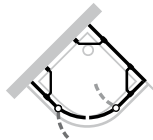
Swing door, quadrant U-shaped enclosure

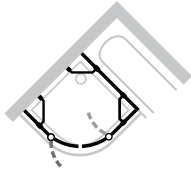
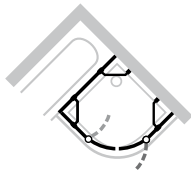
Height	Width	Consisting of:	For ...	Product no.	Price
2000 1200-2000	900-1200 200-1200	1 quadrant swing door with fixed segments, 2-panel, left 1 side panel, right		SR8680	5.075,-
2000 1200-2000	900-1200 200-1200	1 quadrant swing door with fixed segments, 2-panel, right 1 side panel, left		SR8681	5.075,-
2000 1200-2000	900-1200 200-1200	1 quadrant swing door with fixed segments, 2-panel, left 1 shortened side panel, right		SR8682	5.075,-
2000 1200-2000	900-1200 200-1200	1 quadrant swing door with fixed segments, 2-panel, right 1 shortened side panel, left		SR8683	5.075,-

Measurements must always be taken.

Colours - Panel options

Profile colours	Colour code	Extra charges
Silver high-gloss	092	0,-

Panel options	without Anti-Plaque		with Anti-Plaque	
	Glass code	Extra charges	Glass code	Extra charges
Clear	321	0,-	322	418,-
Privatima	373	371,-	375	789,-
Bubbles	376		377	

Swing door, pentagonal U-shaped enclosure

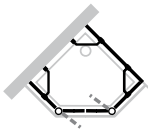
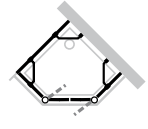
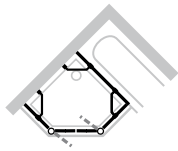
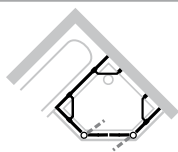
Height	Width	Consisting of:	For ...	Product no.	Price
1200-2000 1200-2000	700-1200 200-1200	1 pentagonal swing door with fixed segments, 2-panel, left 1 side panel, right		SR8780	5.075,-
1200-2000 1200-2000	700-1200 200-1200	1 pentagonal swing door with fixed segments, 2-panel, right 1 side panel, left		SR8781	5.075,-
1200-2000 1200-2000	700-1200 200-1200	1 pentagonal swing door with fixed segments, 2-panel, left 1 shortened side panel, right		SR8782	5.075,-
1200-2000 1200-2000	700-1200 200-1200	1 pentagonal swing door with fixed segments, 2-panel, right 1 shortened side panel, left		SR8783	5.075,-

Measurements must always be taken.

Colours - Panel options

Profile colours	Colour code	Extra charges	Panel options		without Anti-Plaque		with Anti-Plaque	
			Glass code	Extra charges	Glass code	Extra charges		
Silver high-gloss	092	0,-	Clear	321	0,-	322	418,-	
			Sand Plus	315		316		
			Privatima	373	371,-	375	789,-	
			Bubbles	376		377		

HÜPPE Solva pure partially framed model overview - Base price

Rectangular

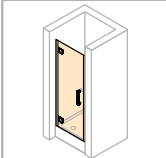
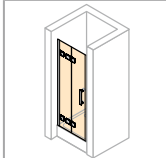
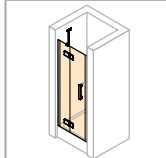
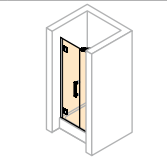
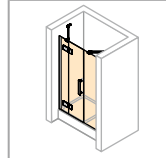
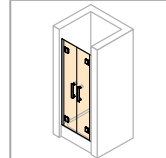
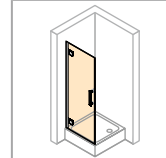
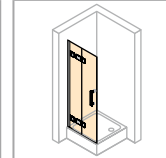
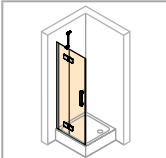
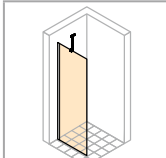
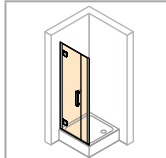
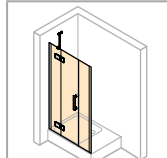
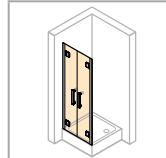
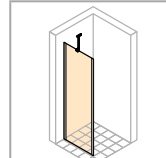
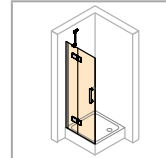
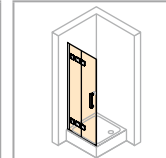
Swing door in recess  1.440,- L.4-L.5	Folding swing door in recess  1.584,- L.6-L.7	Swing door with fixed segment in recess  1.440,- L.8-L.9	Swing door with additional section in recess  1.815,- L.10-L.11	Swing door with fixed segment and additional section in recess  1.847,- L.12-L.13	Two-way door in recess  1.440,- L.14-L.15	Swing door for side panel  1.440,- L.16-L.17	Folding swing door for side panel  1.584,- L.18-L.19
Swing door with fixed segment for side panel  1.440,- L.20-L.23	Side panel for swing door/Folding swing door/Swing door with fixed segment  984,- L.24-L.25	Swing door with additional section for side panel  1.440,- L.26-L.27	Swing door with fixed segment, plus additional section for side panel  1.815,- L.28-L.31	Two-way door for side panel  1.847,- L.32-L.33	Side panel for swing door with additional section/Swing door with fixed segment and additional section/Two-way door  984,- L.34-L.37	Swing door with fixed segment for corner entry  1.609,- L.38-L.39	Folding swing door for corner entry  1.569,- L.40-L.41

Quadrant

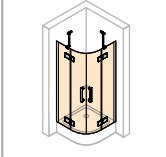
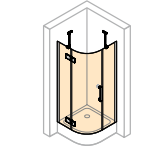
Swing door with fixed segments, 2-panel  2.854,- L.42-L.43	Swing door with fixed segments, 1-panel  2.854,- L.44-L.45
---	--

Pentagonal

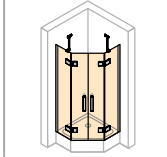
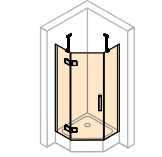
Swing door with fixed segments, 2-panel  2.854,- L.46-L.47	Swing door with fixed segments, 1-panel  2.854,- L.48-L.49
--	--

U-shaped enclosure

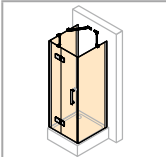
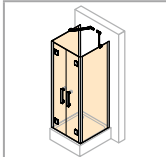
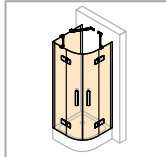
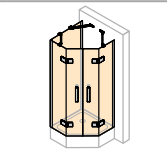
Swing door, rectangular U-shaped enclosure  3.797,- L.50-L.52	Two-way door, rectangular U-shaped enclosure  4.314,- L.53	Swing door, quadrant U-shaped enclosure  4.608,- L.54	Swing door, pentagonal U-shaped enclosure  4.608,- L.55
---	---	--	--

Walk-In

Walk-In side panel
with movable segment

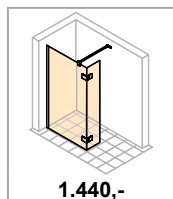

S.28-S.29

Bath-top shower screen

1-panel

1-panel with fixed
segment

Folding swing door

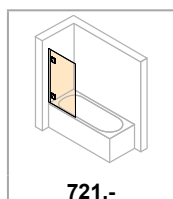

T.34-T.35

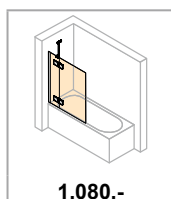

T.36-T.37

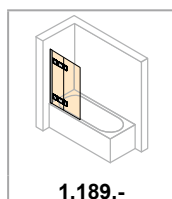

T.38-T.39

HÜPPE Solva pure partially framed



Product details



HÜPPE Solva pure is equipped with a high quality handle combination - an attractive bow-shaped handle outside, a knob handle inside for easy cleaning



The hinge can be opened inwards and outwards. This saves space and provides perfect ventilation in the shower area.



Partially-framed direct stop hinge: the high quality anodised wall profile hides the intelligent hinge connection



NEW TECHNOLOGY: The rise & fall mechanism - now discreetly hidden behind a cover - gently lifts the door on opening. This spares the lower seals and enables almost automatic closing of the doors



NEW TECHNOLOGY: The new HÜPPE SoftSeal technology now provides maximum water-tightness despite a heavy load on the hinges



All HÜPPE Solva pure models can be optionally installed with a drip deflector strip for optimum tightness or without for a barrier free easy entry

HÜPPE Solva pure partially framed Rectangular

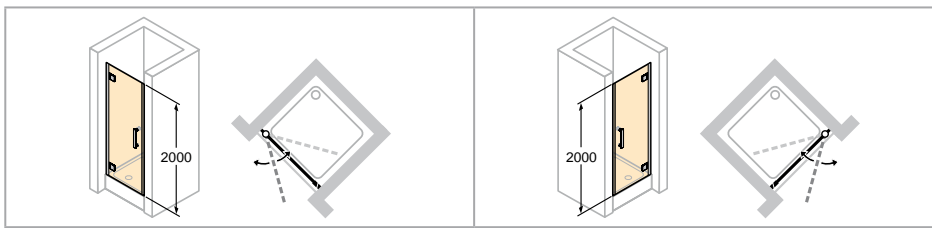

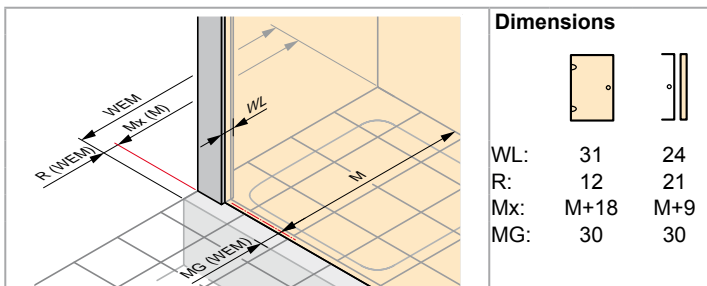

Left-hand fixing

Right-hand fixing



Dimensions

		
WL:	31	24
R:	12	21
Mx:	M+18	M+9
MG:	30	30

WEM = Tray installation dim. (000)

M = installation dimension Centre glass (001)

Please always specify when ordering.

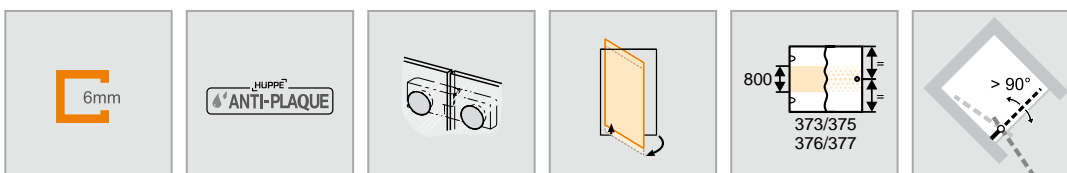

Swing door in recess

Height	Model	WEM	M (middle of glass)	Entry width	Left-hand fixing Product no.	Right-hand fixing Product no.	Base price
2000	800	775-805	775-805	659	ST2301	ST2401	1.440,-
	900	875-905	875-905	759	ST2302	ST2402	
	1000	975-1005	975-1005	859	ST2303	ST2403	1.513,-

Made-to-measure

Height	Width Door front	Left-hand fixing Product no.	Right-hand fixing Product no.	Base price
1200-2000	500-1000	ST2380	ST2480	1.829,-
2001-2200	500-900	ST2381	ST2481	2.376,-

Adjustment range = dimensions - 15mm / + 15mm

Slopes and cut-outs

Slopes and cut-outs	Extra charges
	Supplement per slope/cut-out for made-to-measure 170,-

Dim. Range: min. - max.

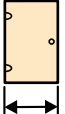
	
1200-2000	500-1000
2001-2200	500-900

Extras

Height	Profile	Product no.	Price
2000	15mm extension profile, hinge side	ST7001	32,-
	15mm extension profile for fixed segment, recess profile or additional section	 ST7003	

Colours - Panel options

Profile colours	Colour code	Extra charges	Panel options		without Anti-Plaque		with Anti-Plaque	
			Glass code	Extra charges	Glass code	Extra charges		
Silver high-gloss	092	0,-	Clear	321	0,-	322	209,-	
			Grey	301		368		
			Bronze	341		378		
			Sand Plus	315	186,-	316	395,-	
			Privatima	373		375		
			Bubbles	376		377		
			Mirror glass	380	439,-	381	648,-	

HÜPPE Solva pure partially framed Rectangular

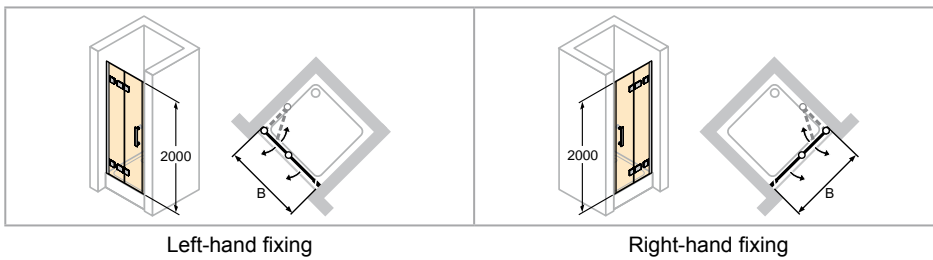

- Mirror glass (380/381): Please state in your order which segment should be produced with mirror glass. If this is not stated, the entire unit will be produced with mirror glass.
- For technical information, see Profile Colours and Panel Options section.

Dimensions

WL:	31	24
R:	12	21
Mx:	M+18	M+9
MG:	30	30

WEM = Tray installation dim. (000)
M = installation dimension Centre glass (001)
Please always specify when ordering.

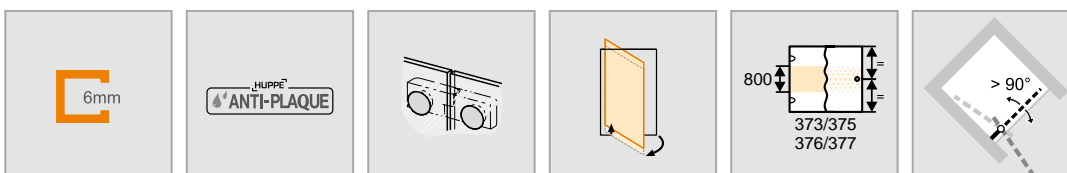

Folding swing door in recess

Height	Model	WEM B	M (middle of glass) B	Folded width F	Profile thickness P	Entry width	Left-hand fixing Product no.	Right-hand fixing Product no.	Base price
2000	700	675-705	675-705	317	95-110	549	ST4301	ST4401	1.584,-
	750	725-755	725-755	342	95-110	599	ST4302	ST4402	
	800	775-805	775-805	367	95-110	649	ST4303	ST4403	
	900	875-905	875-905	417	95-110	749	ST4304	ST4404	1.663,-
	1000	975-1005	975-1005	467	95-110	849	ST4305	ST4405	
1200	1175-1205	1175-1205	567	95-110	1049	ST4306	ST4406	1.694,-	

Made-to-measure



Height	Width Door front	Left-hand fixing Product no.	Right-hand fixing Product no.	Base price
1200-2000	500-1250	ST4380	ST4480	2.011,-

Adjustment range = dimensions - 15mm / + 15mm

Slopes and cut-outs

Slopes and cut-outs	Extra charges
	Supplement per slope/cut-out for made-to-measure 170,-

Dim. Range: min. - max.

	
1200-2000	500-1250

Extras

Height	Profile	Product no.	Price
2000	15mm extension profile, hinge side	ST7001	32,-
	15mm extension profile for fixed segment, recess profile or additional section	ST7003	

Colours - Panel options

Profile colours	Colour code	Extra charges	Panel options		without Anti-Plaque		with Anti-Plaque	
					Glass code	Extra charges	Glass code	Extra charges
Silver high-gloss	092	0,-	Clear	321	0,-	322	209,-	
			Grey	301		368		
			Bronze	341	186,-	378	395,-	
			Sand Plus	315		316		
			Privatima	373		375		
			Bubbles	376		377		
			Mirror glass	380	439,-	381	648,-	

HÜPPE Solva pure partially framed Rectangular

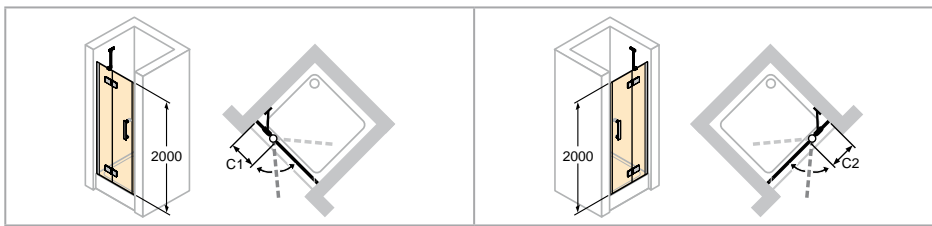

Left-hand fixing

Right-hand fixing

- Mirror glass (380/381): Please state in your order which segment should be produced with mirror glass. If this is not stated, the entire unit will be produced with mirror glass.
- For technical information, see Profile Colours and Panel Options section.

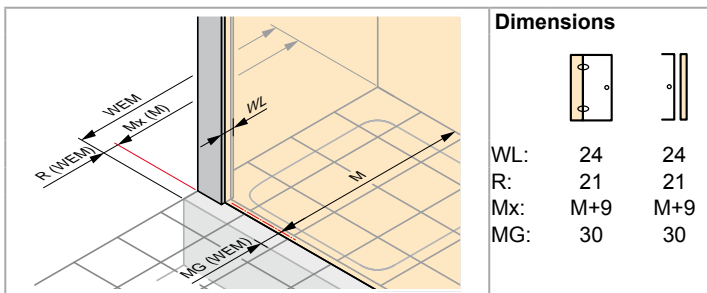

WEM = Tray installation dim. (000)
M = installation dimension Centre glass (001)
Please always specify when ordering.

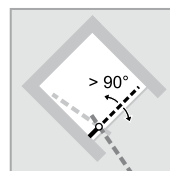
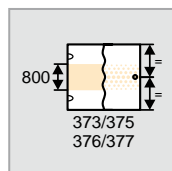
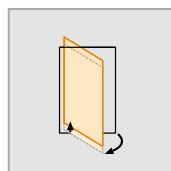
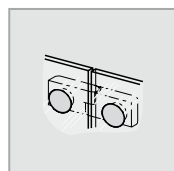
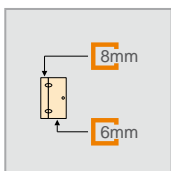

Swing door with fixed segment in recess

Height	Model	WEM	M (middle of glass)	C1/C2	Entry width	Left-hand fixing Product no.	Right-hand fixing Product no.	Base price
2000	800	775-805	775-805	266-281	450	ST0401	ST0501	1.440,-
	900	875-905	875-905	266-281	550	ST0402	ST0502	
	1000	975-1005	975-1005	266-281	650	ST0403	ST0503	1.513,-
	1100	1075-1105	1075-1105	266-281	750	ST0407	ST0507	
	1200	1175-1205	1175-1205	366-381	750	ST0404	ST0504	1.541,-
	1300	1275-1305	1275-1305	366-381	850	ST0405	ST0505	
	1400	1375-1405	1375-1405	466-481	850	ST0406	ST0506	1.612,-

Made-to-measure

Height	Width Door front	Left-hand fixing Product no.	Right-hand fixing Product no.	Base price
1200-2000	700-1200	ST0480	ST0580	1.829,-
	1201-1500	ST0482	ST0582	2.485,-
2001-2200	700-1200	ST0481	ST0581	2.376,-
	1201-1500	ST0483	ST0583	3.032,-





Adjustment range = dimensions - 15mm / + 15mm

The width of the fixed segment must be stated.

Slopes and cut-outs

Slopes and cut-outs	Extra charges
	Supplement per slope/cut-out for made-to-measure 170,-

Dim. Range: min. - max.

			
1200-2200	700-1500	200-600	max. 900

Extras

Height	Profile	Product no.	Price
2000	15mm extension profile for fixed segment, recess profile or additional section	 ST7003	32,-

Special options

Special options	Extra charges
T-solution brace, complete (solid wall/glass/solid wall) to 2000mm x 150mm	 925 208,-

Colours - Panel options

Profile colours	Colour code	Extra charges	Panel options		without Anti-Plaque		with Anti-Plaque	
			Glass code	Extra charges	Glass code	Extra charges		
Silver high-gloss	092	0,-	Clear	321	0,-	322	209,-	
			Grey	301		368		
			Bronze	341	186,-	378	395,-	
			Sand Plus	315		316		
			Privatima	373		375		
			Bubbles	376		377		
			Mirror glass	380	439,-	381	648,-	

HÜPPE Solva pure partially framed Rectangular

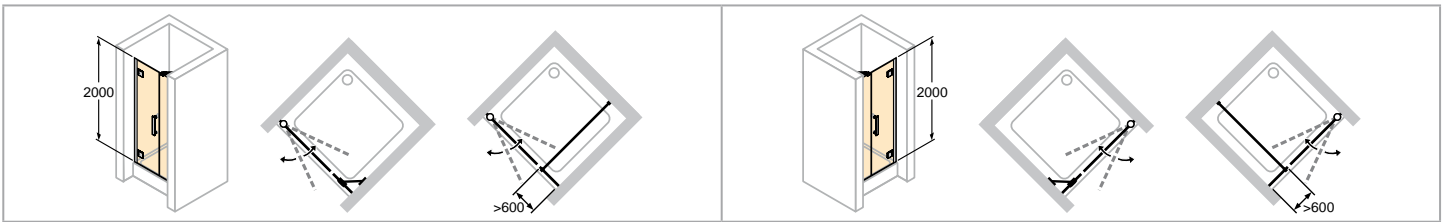

Left-hand fixing

Right-hand fixing

- Mirror glass (380/381): Please state in your order which segment should be produced with mirror glass. If this is not stated, the entire unit will be produced with mirror glass.
- For technical information, see Profile Colours and Panel Options section.

Dimensions

WL:	31	24
R:	12	21
Mx:	M+18	M+9
MG:	30	30

WEM = Tray installation dim. (000)
M = installation dimension Centre glass (001)
Please always specify when ordering.

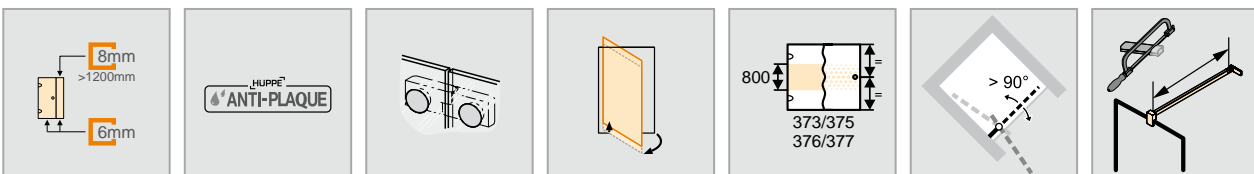

Swing door with additional section in recess

Height	Model	WEM	M (middle of glass)	Width additional section	Entry width	Left-hand fixing Product no.	Right-hand fixing Product no.	Base price
2000	800	775-805	775-805	261-276	450	ST2901	ST3001	1.440,-
	900	875-905	875-905	261-276	550	ST2902	ST3002	
	1000	975-1005	975-1005	261-276	650	ST2903	ST3003	1.513,-
	1200	1175-1205	1175-1205	361-376	750	ST2904	ST3004	1.541,-

Made-to-measure

Height	Width Door front	Left-hand fixing Product no.	Right-hand fixing Product no.	Base price
1200-2000	700-1200	ST2980	ST3080	1.829,-
	1201-2800	ST2982	ST3082	2.485,-
2001-2200	700-1200	ST2981	ST3081	2.376,-
	1201-2700	ST2983	ST3083	3.032,-





Adjustment range = dimensions - 15mm / + 5mm

The width of the additional section must be stated.

Slopes and cut-outs

Slopes and cut-outs	Extra charges
	Supplement per slope/cut-out for made-to-measure 170,-

Dim. Range: min. - max.

			
1200-2000	700-2800	max. 1000	200-1800
2001-2200	700-2700	max. 900	200-1800

Extras

Height	Profile	Product no.	Price
2000	15mm extension profile, hinge side	ST7001	32,-
	15mm extension profile for fixed segment, recess profile or additional section	ST7003	

Special options

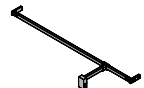
Special options	Extra charges
T-solution brace, complete (solid wall/glass/solid wall) to 2000mm x 150mm	 925 208,-

Colours - Panel options

Profile colours	Colour code	Extra charges	Panel options		without Anti-Plaque		with Anti-Plaque	
					Glass code	Extra charges	Glass code	Extra charges
Silver high-gloss	092	0,-	Clear	321	0,-	322	209,-	
			Grey	301		368		
			Bronze	341	186,-	378	395,-	
			Sand Plus	315		316		
			Privatima	373		375		
			Bubbles	376		377		
			Mirror glass	380	439,-	381	648,-	

HÜPPE Solva pure partially framed Rectangular

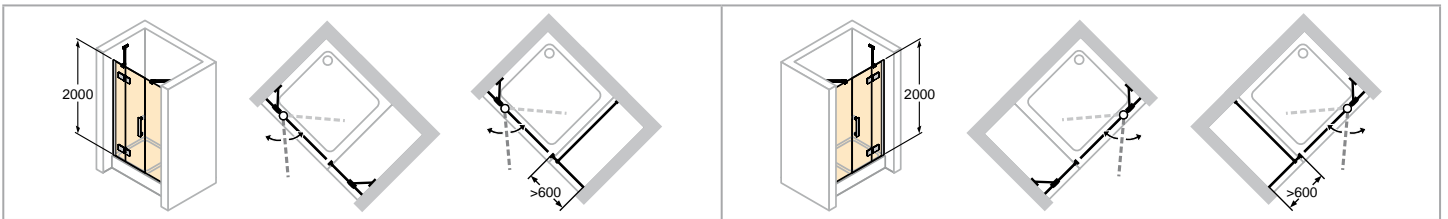

Left-hand fixing

Right-hand fixing

- Mirror glass (380/381): Please state in your order which segment should be produced with mirror glass. If this is not stated, the entire unit will be produced with mirror glass.
- For technical information, see Profile Colours and Panel Options section.

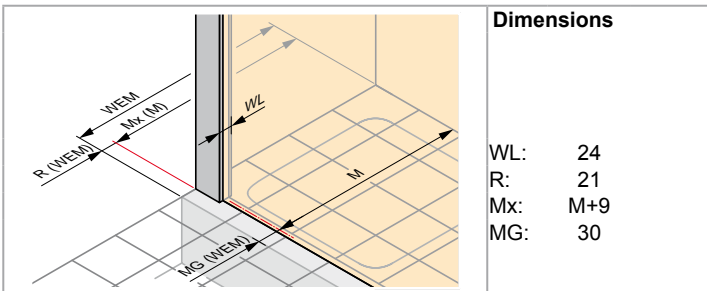

WEM = Tray installation dim. (000)
 M = installation dimension Centre glass (001)
 Please always specify when ordering.

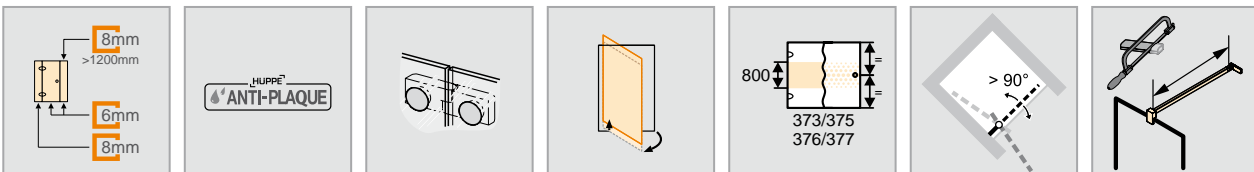

Swing door with fixed segment and additional section in recess

Height	Model	WEM	M (middle of glass)	Width of fixed segment	Width additional section	Entry width	Left-hand fixing Product no.	Right-hand fixing Product no.	Base price
2000	1100	1075-1105	1075-1105	268-283	241-256	550	ST1401	ST1501	1.815,-
	1200	1175-1205	1175-1205	268-283	241-256	650	ST1402	ST1502	
	1300	1275-1305	1275-1305	268-283	241-256	750	ST1403	ST1503	
	1400	1375-1405	1375-1405	368-383	241-256	750	ST1404	ST1504	
	1500	1475-1505	1475-1505	368-383	241-256	850	ST1405	ST1505	2.145,-
	1600	1575-1605	1575-1605	368-383	341-356	850	ST1406	ST1506	
	1700	1675-1705	1675-1705	468-483	341-356	850	ST1407	ST1507	2.325,-
1800	1775-1805	1775-1805	468-483	441-456	850	ST1408	ST1508		

Made-to-measure

Height	Width Door front	Left-hand fixing Product no.	Right-hand fixing Product no.	Base price
1200-2000	1100-1500	ST1480	ST1580	2.304,-
	1501-3300	ST1482	ST1582	2.960,-
2001-2200	1100-1500	ST1481	ST1581	2.851,-
	1501-3300	ST1483	ST1583	3.508,-





Adjustment range = dimensions - 15mm / + 15mm

The width of the fixed segment and additional section must be stated.

Slopes and cut-outs

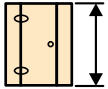
Slopes and cut-outs	Extra charges
	Supplement per slope/cut-out for made-to-measure 170,-

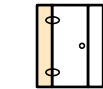
Dim. Range: min. - max.

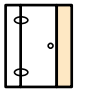
				
1200-2200	1100-3300	200-600	max. 900	200-1800

Extras

Height	Profile	Product no.	Price
2000	15mm extension profile for fixed segment, recess profile or additional section	 ST7003	32,-

Special options

Special options	Extra charges
F-solution brace, complete (solid wall/glass/glass/solid wall) to 2000mm x 150mm x 150mm	 926 371,-

Colours - Panel options

Profile colours	Colour code	Extra charges	Panel options		without Anti-Plaque		with Anti-Plaque	
			Glass code	Extra charges	Glass code	Extra charges		
Silver high-gloss	092	0,-	Clear	321	0,-	322	418,-	
			Grey	301		368		
			Bronze	341	371,-	378	789,-	
			Sand Plus	315		316		
			Privatima	373		375		
			Bubbles	376		377		
			Mirror glass	380	439,-	381	857,-	

HÜPPE Solva pure partially framed Rectangular

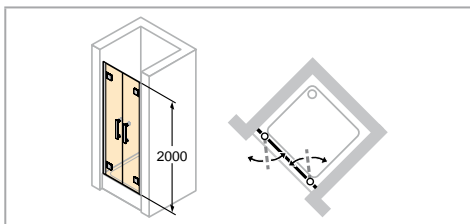

- Mirror glass (380/381): Please state in your order which segment should be produced with mirror glass. If this is not stated, the entire unit will be produced with mirror glass.
- For technical information, see Profile Colours and Panel Options section.

Dimensions

WL: 31
R: 12
Mx: M+18
MG: 30

WEM = Tray installation dim. (000)
M = installation dimension Centre glass (001)
Please always specify when ordering.

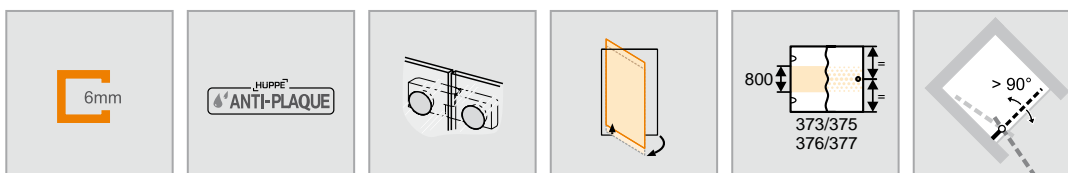

Two-way door in recess

Height	Model	WEM	M (middle of glass)	Entry width	Product no.	Base price
2000	800	775-805	775-805	646	ST3301	1.847,-
	900	875-905	875-905	746	ST3302	
	1000	975-1005	975-1005	846	ST3303	1.938,-
	1100	1075-1105	1075-1105	946	ST3304	
	1200	1175-1205	1175-1205	1046	ST3305	

Made-to-measure

Height	Width Door front	Product no.	Base price
1200-2000	600-1200	ST3380	2.344,-
	1201-1800	ST3382	3.002,-
2001-2200	600-1200	ST3381	2.893,-
	1201-1800	ST3383	3.549,-

Adjustment range = dimensions - 15mm / + 15mm

Dim. Range: min. - max.

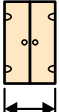
	
1200-2200	600-1800

Extras

Height		Product no.	Price
2000	15mm extension profile, hinge side	ST7001	32,-

Colours - Panel options

Profile colours	Colour code	Extra charges	Panel options		without Anti-Plaque		with Anti-Plaque	
					Glass code	Extra charges	Glass code	Extra charges
Silver high-gloss	092	0,-	Clear	321	0,-	322	209,-	
			Grey	301		368		
			Bronze	341	186,-	378	395,-	
			Sand Plus	315		316		
			Privatima	373		375		
			Bubbles	376		377		
			Mirror glass	380	439,-	381	648,-	

HÜPPE Solva pure partially framed Rectangular

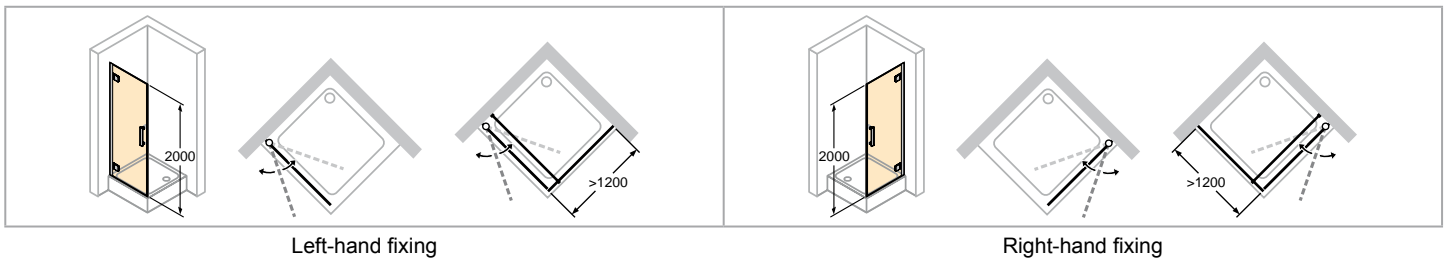

• For technical information, see Profile Colours and Panel Options section.

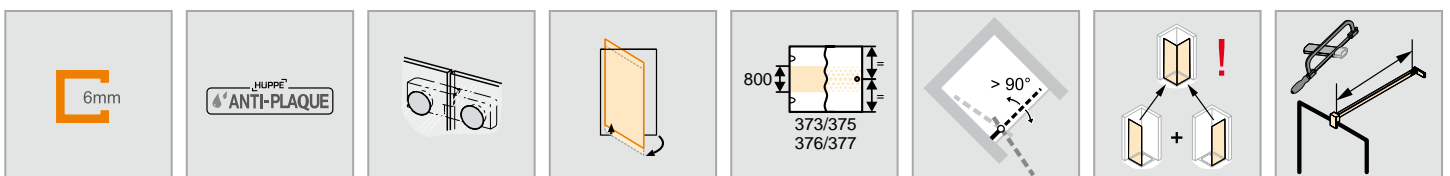
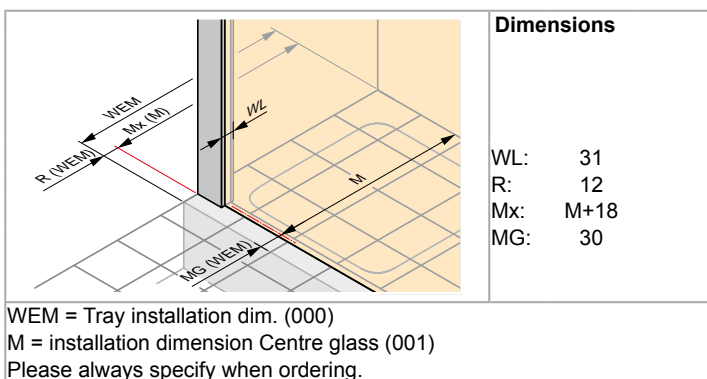

Swing door for side panel

Installation on shower tray recommended

Height	Model	WEM	M (middle of glass)	Entry width	Left-hand fixing Product no.	Right-hand fixing Product no.	Base price
2000	750	740-755	710-725	634	ST2501	ST2601	1.440,-
	800	790-805	760-775	684	ST2502	ST2602	
	900	890-905	860-875	784	ST2503	ST2603	
	1000	990-1005	960-975	864	ST2504	ST2604	1.513,-

Floor-flush installation recommended

Height	Model	M (middle of glass)	Entry width	Left-hand fixing Product no.	Right-hand fixing Product no.	Base price
2000	750	742-757	666	ST2505	ST2605	1.440,-
	800	792-807	716	ST2506	ST2606	
	900	892-907	816	ST2507	ST2607	
	1000	992-1007	916	ST2508	ST2608	1.513,-

Made-to-measure



Height	Width Door front	Left-hand fixing Product no.	Right-hand fixing Product no.	Base price
1200-2000	500-1000	ST2580	ST2680	1.829,-
2001-2200	500-900	ST2581	ST2681	2.102,-

Adjustment range = dimensions - 8mm / + 7mm

Slopes and cut-outs

Slopes and cut-outs	Extra charges
	Supplement per slope/cut-out for made-to-measure 170,-

Dim. Range: min. - max.

	
1200-2000	500-1000
2001-2200	500-900

Extras

Height	Product no.	Price
2000	15mm extension profile, hinge side ST7001	32,-

Colours - Panel options

Profile colours	Colour code	Extra charges	Panel options	without Anti-Plaque		with Anti-Plaque	
				Glass code	Extra charges	Glass code	Extra charges
Silver high-gloss	092	0,-	Clear	321	0,-	322	209,-
			Grey	301		368	
			Bronze	341	186,-	378	395,-
			Sand Plus	315		316	
			Privatima	373		375	
			Bubbles	376	377		
			Mirror glass	380	439,-	381	648,-

HÜPPE Solva pure partially framed Rectangular

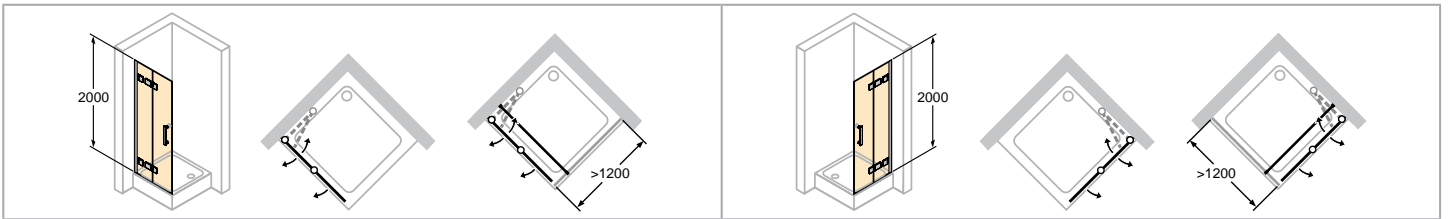

Left-hand fixing

Right-hand fixing

- Mirror glass (380/381): Please state in your order which segment should be produced with mirror glass. If this is not stated, the entire unit will be produced with mirror glass.
- For technical information, see Profile Colours and Panel Options section.

	<p>Dimensions</p> <p>WL: 31 R: 12 Mx: M+18 MG: 30</p>
<p>WEM = Tray installation dim. (000) M = installation dimension Centre glass (001) Please always specify when ordering.</p>	

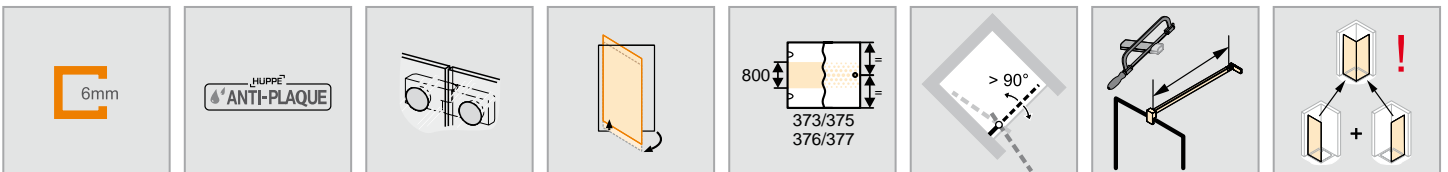

Folding swing door for side panel

Installation on shower tray recommended

Height	Model	WEM	M (middle of glass)	Folded width F	Profile thickness P	Entry width	Left-hand fixing Product no.	Right-hand fixing Product no.	Base price
2000	700	690-705	660-675	321	95-110	574	ST4501	ST4601	1.584,-
	750	740-755	710-725	346	95-110	624	ST4502	ST4602	
	800	790-805	760-775	371	95-110	674	ST4503	ST4603	
	900	890-905	860-875	421	95-110	774	ST4504	ST4604	1.663,-
	1000	990-1005	960-975	471	95-110	874	ST4505	ST4605	
	1200	1190-1205	1160-1175	571	95-110	1074	ST4506	ST4606	

Floor-flush installation recommended

Height	Model	M (middle of glass)	Folded width F	Profile thickness P	Entry width	Left-hand fixing Product no.	Right-hand fixing Product no.	Base price
2000	700	692-707	337	95-110	604	ST4507	ST4607	1.584,-
	750	742-757	362	95-110	654	ST4508	ST4608	
	800	792-807	387	95-110	704	ST4509	ST4609	
	900	892-907	437	95-110	804	ST4510	ST4610	1.663,-
	1000	992-1007	487	95-110	904	ST4511	ST4611	
	1200	1192-1207	587	95-110	1104	ST4512	ST4612	

Made-to-measure

Height	Width of door front	Left-hand fixing Product no.	Right-hand fixing Product no.	Base price
1200-2000	500-1250	ST4580	ST4680	2.011,-

Adjustment range = dimensions - 8mm / + 7mm

Slopes and cut-outs

Slopes and cut-outs	Extra charges
	Supplement per slope/cut-out for made-to-measure 170,-

Dim. Range: min. - max.

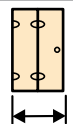
	
1200-2000	500-1250

Extras

Height	Product no.	Price
2000	15mm extension profile, hinge side ST7001	32,-

Colours - Panel options

Profile colours	Colour code	Extra charges	Panel options	without Anti-Plaque		with Anti-Plaque	
				Glass code	Extra charges	Glass code	Extra charges
Silver high-gloss	092	0,-	Clear	321	0,-	322	209,-
			Grey	301		368	
			Bronze	341	186,-	378	395,-
			Sand Plus	315		316	
			Privatima	373		375	
			Bubbles	376	377		
			Mirror glass	380	439,-	381	648,-

HÜPPE Solva pure partially framed Rectangular

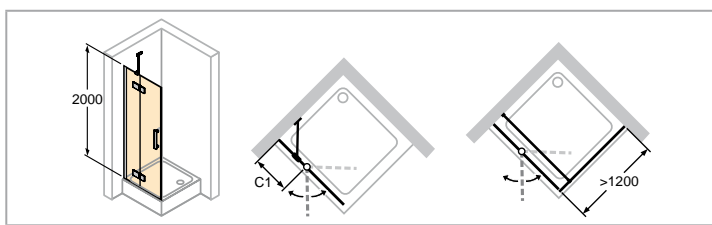

- Mirror glass (380/381): Please state in your order which segment should be produced with mirror glass. If this is not stated, the entire unit will be produced with mirror glass.
- For technical information, see Profile Colours and Panel Options section.

Dimensions	
WL:	24
R:	21
Mx:	M+9
MG:	30

WEM = Tray installation dim. (000)
M = installation dimension Centre glass (001)
Please always specify when ordering.

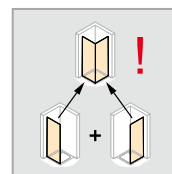
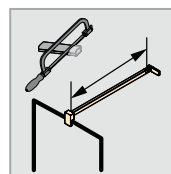
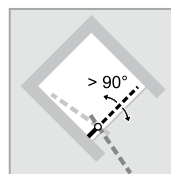
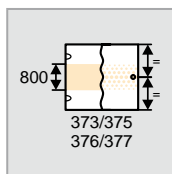
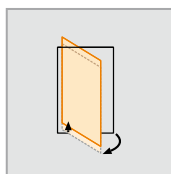
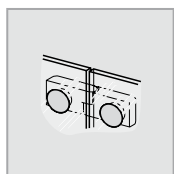
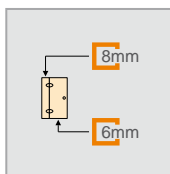

Swing door with fixed segment for side panel

Left-hand fixing

Installation on shower tray recommended

Height	Model	WEM	M (middle of glass)	C1	Entry width	Product no.	Base price
2000	750	740-755	710-725	232-247	450	ST0601	1.440,-
	800	790-805	760-775	282-297	450	ST0602	
	900	890-905	860-875	282-297	550	ST0603	
	1000	990-1005	960-975	382-397	550	ST0604	1.513,-
	1100	1090-1105	1060-1075	482-497	550	ST0611	
	1200	1190-1205	1160-1175	482-497	650	ST0605	1.541,-
	1300	1290-1305	1260-1275	482-497	750	ST0612	1.612,-
	1400	1390-1405	1360-1375	582-597	750	ST0613	

Left-hand fixing

Floor-flush installation recommended

Height	Model	M (middle of glass)	C1	Entry width	Product no.	Base price
2000	750	742-757	264-279	450	ST0606	1.440,-
	800	792-807	314-329	450	ST0607	
	900	892-907	314-329	550	ST0608	
	1000	992-1007	414-429	550	ST0609	1.513,-
	1100	1092-1107	514-529	550	ST0614	
	1200	1192-1207	514-529	650	ST0610	1.541,-
	1300	1292-1307	514-529	750	ST0615	1.612,-
	1400	1392-1407	614-629	750	ST0616	

Made-to-measure - Left-hand fixing

Height	Width of door front	Product no.	Base price
1200-2000	700-1200	ST0680	1.829,-
	1201-1500	ST0682	2.157,-
2001-2200	700-1200	ST0681	2.102,-
	1201-1500	ST0683	2.429,-





Adjustment range = dimensions - 8mm / + 7mm

The width of the fixed segment must be stated.

Slopes and cut-outs

Slopes and cut-outs	Extra charges
	Supplement per slope/cut-out for made-to-measure 170,-

Dim. Range: min. - max.

			
1200-2200	700-1500	200-600	max. 900

Extras

Height	Profile	Product no.	Price
2000	15mm extension profile for fixed segment, recess profile or additional section	 ST7003	32,-

Special options

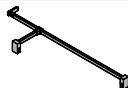
Special options	Extra charges
T-solution brace, complete (solid wall/glass/glass) to 2000mm x 150mm	 927 148,-

Colours - Panel options

Profile colours	Colour code	Extra charges	Panel options		without Anti-Plaque		with Anti-Plaque	
			Glass code	Extra charges	Glass code	Extra charges		
Silver high-gloss	092	0,-	Clear	321	0,-	322	209,-	
			Grey	301		368		
			Bronze	341	186,-	378	395,-	
			Sand Plus	315		316		
			Privatima	373		375		
			Bubbles	376		377		
			Mirror glass	380	439,-	381	648,-	

HÜPPE Solva pure partially framed Rectangular

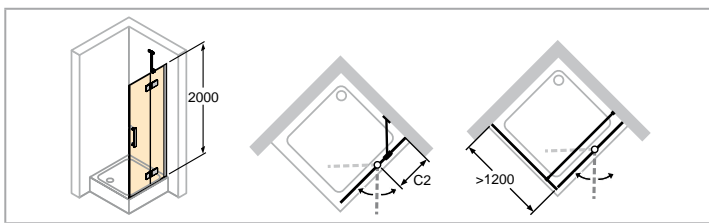

- Mirror glass (380/381): Please state in your order which segment should be produced with mirror glass. If this is not stated, the entire unit will be produced with mirror glass.
- For technical information, see Profile Colours and Panel Options section.

Dimensions

WL:	24
R:	21
Mx:	M+9
MG:	30

WEM = Tray installation dim. (000)
M = installation dimension Centre glass (001)
Please always specify when ordering.

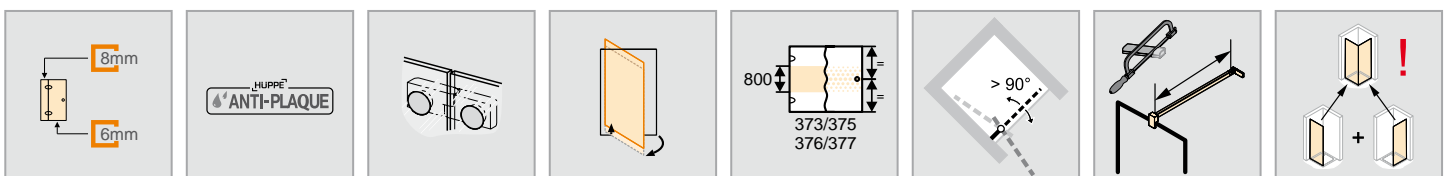

Swing door with fixed segment for side panel

Right-hand fixing

Installation on shower tray recommended

Height	Model	WEM	M (middle of glass)	C2	Entry width	Product no.	Base price
2000	750	740-755	710-725	232-247	450	ST0701	1.440,-
	800	790-805	760-775	282-297	450	ST0702	
	900	890-905	860-875	282-297	550	ST0703	
	1000	990-1005	960-975	382-397	550	ST0704	1.513,-
	1100	1090-1105	1060-1075	482-497	550	ST0711	
	1200	1190-1205	1160-1175	482-497	650	ST0705	
	1300	1290-1305	1260-1275	482-497	750	ST0712	1.612,-
	1400	1390-1405	1360-1375	582-597	750	ST0713	

Right-hand fixing

Floor-flush installation recommended

Height	Model	M (middle of glass)	C2	Entry width	Product no.	Base price
2000	750	742-757	264-279	450	ST0706	1.440,-
	800	792-807	314-329	450	ST0707	
	900	892-907	314-329	550	ST0708	
	1000	992-1007	414-429	550	ST0709	1.513,-
	1100	1092-1107	514-529	550	ST0714	
	1200	1192-1207	514-529	650	ST0710	
	1300	1292-1307	514-529	750	ST0715	1.612,-
	1400	1392-1407	614-629	750	ST0716	

Made-to-measure - Right-hand fixing

Height	Width of door front	Product no.	Base price
1200-2000	700-1200	ST0780	1.829,-
	1201-1500	ST0782	2.157,-
2001-2200	700-1200	ST0781	2.102,-
	1201-1500	ST0783	2.429,-





Adjustment range = dimensions - 8mm / + 7mm

The width of the fixed segment must be stated.

Slopes and cut-outs

Slopes and cut-outs	Extra charges
	Supplement per slope/cut-out for made-to-measure 170,-

Dim. Range: min. - max.

			
1200-2200	700-1500	200-600	max. 900

Extras

Height	Profile	Product no.	Price
2000	15mm extension profile for fixed segment, recess profile or additional section	ST7003	32,-

Special options

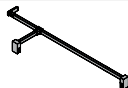
Special options	Extra charges
T-solution brace, complete (solid wall/glass/glass) to 2000mm x 150mm	 927 148,-

Colours - Panel options

Profile colours	Colour code	Extra charges	Panel options		without Anti-Plaque		with Anti-Plaque	
			Glass code	Extra charges	Glass code	Extra charges		
Silver high-gloss	092	0,-	Clear	321	0,-	322	209,-	
			Grey	301		368		
			Bronze	341	186,-	378	395,-	
			Sand Plus	315		316		
			Privatima	373		375		
			Bubbles	376		377		
			Mirror glass	380	439,-	381	648,-	

HÜPPE Solva pure partially framed Rectangular

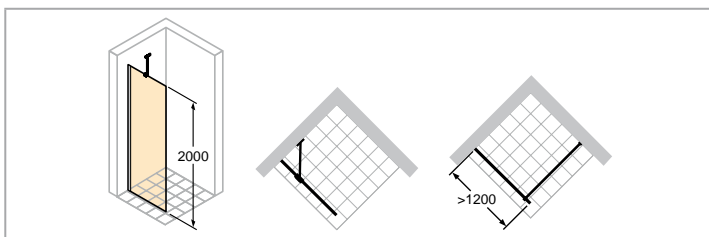

- Shortened side panel can only be combined with door in recess.
- Towel rail height can be selected individually and must be specified with the order. If nothing is specified, the towel rail is always delivered middle of glass (height and width).

Dimensions

WL: 24
R: 21
Mx: M+9
MG: 30

WEM = Tray installation dim. (000)
M = installation dimension Centre glass (001)
Please always specify when ordering.

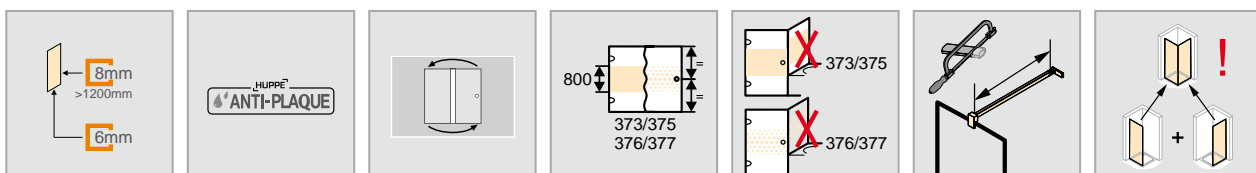

Side panel for swing door/Folding swing door/Swing door with fixed segment

Installation on shower tray recommended

Height	Model	WEM	M (middle of glass)	Product no.	Base price
2000	SW 700	690-705	660-675	ST0801	984,-
	SW 750	740-755	710-725	ST0802	
	SW 800	790-805	760-775	ST0803	
	SW 900	890-905	860-875	ST0804	
	SW 1000	990-1005	960-975	ST0805	1.033,-
	SW 1200	1190-1205	1160-1175	ST0806	1.053,-

Floor-flush installation recommended

Height	Model	M (middle of glass)	Product no.	Base price
2000	SW 700	692-707	ST0812	984,-
	SW 750	742-757	ST0813	
	SW 800	792-807	ST0814	
	SW 900	892-907	ST0815	
	SW 1000	992-1007	ST0816	1.033,-
	SW 1200	1192-1207	ST0817	1.053,-

Made-to-measure



Height	Model	Width	Left-hand/ right-hand fixing Product no.	Left-hand fixing Product no.	Right-hand fixing Product no.	Base price
1200-2000	Standard made-to-measure	200-1200	ST0880			1.248,-
	Standard made-to-measure	1201-1800	ST0882			1.576,-
2001-2200	Standard made-to-measure	200-1200	ST0881			1.522,-
	Standard made-to-measure	1201-1800	ST0883			1.850,-
1200-2000	On bathtub	200-1200		ST5084	ST5184	1.248,-
	On bathtub	1201-1800		ST5086	ST5186	1.576,-

Adjustment range = dimensions - 8mm / + 7mm

Slopes and cut-outs

Slopes and cut-outs	Extra charges
	Supplement per slope/cut-out for made-to-measure 170,-

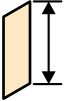
Dim. Range: min. - max.

	
1200-2200	200-1800

Extras

Height	Profile	Product no.	Price
2000	15mm extension profile for fixed segment, recess profile or additional section 	ST7003	32,-

Special options

Special options	Extra charges
Towel rail (silver high-gloss)	T99 210,-

Colours - Panel options

Profile colours	Colour code	Extra charges	Panel options		without Anti-Plaque		with Anti-Plaque	
			Glass code	Extra charges	Glass code	Extra charges		
Silver high-gloss	092	0,-	Clear	321	0,-	322	209,-	
			Grey	301		368		
			Bronze	341	186,-	378	395,-	
			Sand Plus	315		316		
			Privatima	373		375		
			Bubbles	376		377		
			Mirror glass	380	439,-	381	648,-	

HÜPPE Solva pure partially framed Rectangular

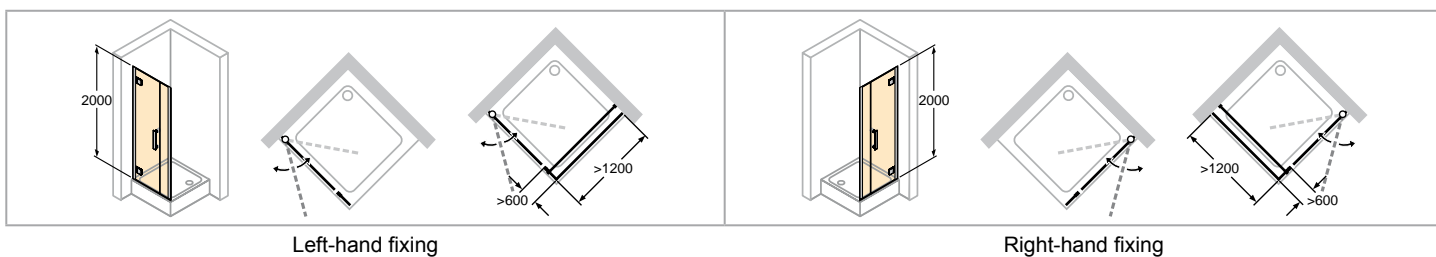

Left-hand fixing

Right-hand fixing

- Mirror glass (380/381): Please state in your order which segment should be produced with mirror glass. If this is not stated, the entire unit will be produced with mirror glass.
- For technical information, see Profile Colours and Panel Options section.

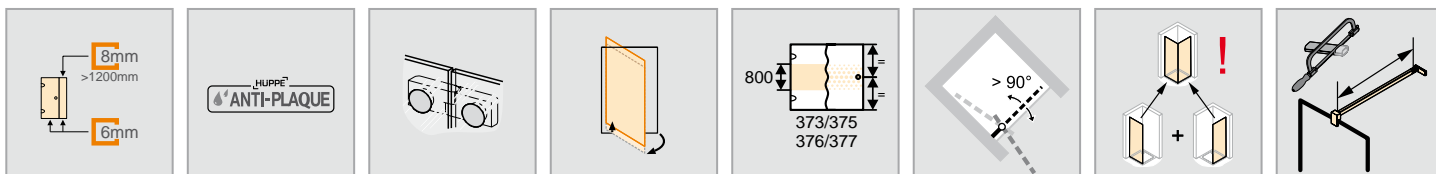
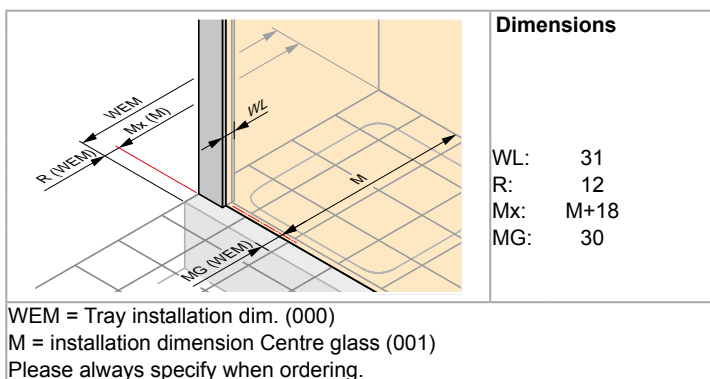

Swing door with additional section for side panel

Installation on shower tray recommended

Height	Model	WEM	M (middle of glass)	Width additional section	Entry width	Left-hand fixing Product no.	Right-hand fixing Product no.	Base price
2000	800	775-805	745-775	261-276	450	ST3101	ST3201	1.440,-
	900	875-905	845-875	261-276	550	ST3102	ST3202	
	1000	975-1005	945-975	261-276	650	ST3103	ST3203	1.513,-
	1200	1175-1205	1145-1175	361-376	750	ST3104	ST3204	1.541,-

Floor-flush installation recommended

Height	Model	M (middle of glass)	Width additional section	Entry width	Left-hand fixing Product no.	Right-hand fixing Product no.	Base price
2000	800	785-815	270-285	450	ST3105	ST3205	1.440,-
	900	885-915	270-285	550	ST3106	ST3206	
	1000	985-1015	270-285	650	ST3107	ST3207	1.513,-
	1200	1185-1215	370-385	750	ST3108	ST3208	1.541,-

Made-to-measure

Height	Width of door front	Left-hand fixing Product no.	Right-hand fixing Product no.	Base price
1200-2000	700-1200	ST3180	ST3280	1.829,-
	1201-2800	ST3182	ST3282	2.157,-
2001-2200	700-1200	ST3181	ST3281	2.102,-
	1201-2700	ST3183	ST3283	2.429,-





Adjustment range = dimensions - 15mm / + 15mm

The width of the additional section must be stated.

Slopes and cut-outs

Slopes and cut-outs	Extra charges
 Supplement per slope/cut-out for made-to-measure	170,-

Dim. Range: min. - max.

			
1200-2000	700-2800	max. 1000	200-1800
2001-2200	700-2700	max. 900	200-1800

Extras

Height	Product no.	Price
2000	15mm extension profile, hinge side ST7001	32,-

Special options

Special options	Product no.	Extra charges
T-solution brace, complete (solid wall/glass/glass) to 2000mm x 150mm	 927	148,-

Colours - Panel options

Profile colours	Colour code	Extra charges	Panel options		without Anti-Plaque		with Anti-Plaque	
					Glass code	Extra charges	Glass code	Extra charges
Silver high-gloss	092	0,-	Clear	321	0,-	322	209,-	
			Grey	301		368		
			Bronze	341	186,-	378	395,-	
			Sand Plus	315		316		
			Privatima	373		375		
			Bubbles	376		377		
			Mirror glass	380	439,-	381	648,-	

HÜPPE Solva pure partially framed Rectangular

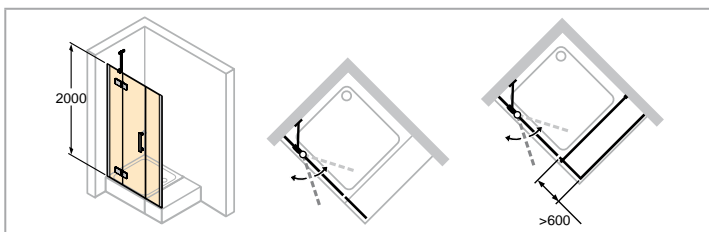

- Mirror glass (380/381): Please state in your order which segment should be produced with mirror glass. If this is not stated, the entire unit will be produced with mirror glass.
- For technical information, see Profile Colours and Panel Options section.

Dimensions

WL: 24
R: 21
Mx: M+9
MG: 30

WEM = Tray installation dim. (000)
M = installation dimension Centre glass (001)
Please always specify when ordering.

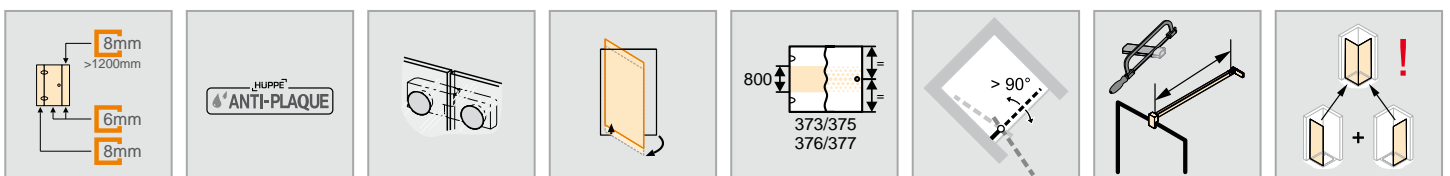

Swing door with fixed segment, plus additional section for side panel

Left-hand fixing

Installation on shower tray recommended

Height	Model	WEM	M (middle of glass)	Width of fixed segment	Width additional section	Entry width	Product no.	Base price
2000	1100	1075-1105	1045-1075	268-283	241-256	550	ST1601	1.815,-
	1200	1175-1205	1145-1175	268-283	241-256	650	ST1602	
	1300	1275-1305	1245-1275	268-283	241-256	750	ST1603	
	1400	1375-1405	1345-1375	368-383	341-356	750	ST1604	
	1500	1475-1505	1445-1475	368-383	341-356	850	ST1605	
	1600	1575-1605	1545-1575	368-383	341-356	850	ST1611	2.145,-
	1700	1675-1705	1645-1675	468-483	441-456	850	ST1612	2.325,-
	1800	1775-1805	1745-1775	468-483	441-456	850	ST1613	

Left-hand fixing

Floor-flush installation recommended

Height	Model	M (middle of glass)	Width of fixed segment	Width additional section	Entry width	Product no.	Base price
2000	1100	1085-1115	272-287	246-270	550	ST1606	1.815,-
	1200	1185-1215	272-287	246-270	650	ST1607	
	1300	1285-1315	272-287	246-270	750	ST1608	
	1400	1385-1415	372-387	346-370	750	ST1609	
	1500	1485-1515	372-387	346-370	850	ST1610	
	1600	1585-1615	372-387	346-370	850	ST1614	2.145,-
	1700	1685-1715	472-487	446-470	850	ST1615	2.325,-
	1800	1785-1815	472-487	446-470	850	ST1616	

Made-to-measure - Left-hand fixing

Height	Width of door front	Product no.	Base price
1200-2000	900-1200	ST1680	2.304,-
	1201-3300	ST1682	2.632,-
2001-2200	900-1200	ST1681	2.578,-
	1201-3300	ST1683	2.905,-





Adjustment range = dimensions - 15mm / + 15mm

The width of the fixed segment and additional section must be stated.

Slopes and cut-outs

Slopes and cut-outs	Extra charges
 Supplement per slope/cut-out for made-to-measure	170,-

Dim. Range: min. - max.

				
1200-2200	900-3300	200-600	max. 900	200-1800

Extras

Height	Profile	Product no.	Price
2000	15mm extension profile for fixed segment, recess profile or additional section	ST7003	32,-

Special options

Optional variants	Extra charges
F-solution stabilizer, complete (solid wall/glass/glass/glass) up to 2000mm x 150mm x 150mm	928 312,-

Colours - Panel options

Profile colours	Colour code	Extra charges	Panel options		without Anti-Plaque		with Anti-Plaque	
			Glass code	Extra charges	Glass code	Extra charges		
Silver high-gloss	092	0,-	Clear	321	0,-	322	418,-	
			Grey	301		368		
			Bronze	341		378		
			Sand Plus	315	371,-	316	789,-	
			Privatima	373		375		
			Bubbles	376		377		
			Mirror glass	380	439,-	381	857,-	

HÜPPE Solva pure partially framed Rectangular

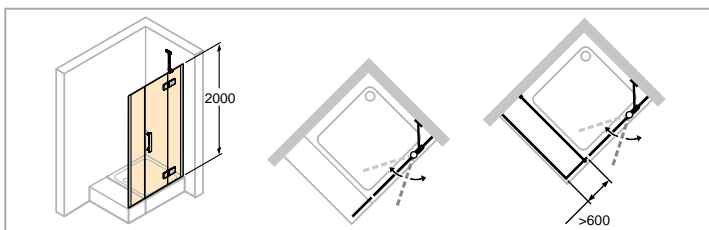

- Mirror glass (380/381): Please state in your order which segment should be produced with mirror glass. If this is not stated, the entire unit will be produced with mirror glass.
- For technical information, see Profile Colours and Panel Options section.

Dimensions

WL: 24
R: 21
Mx: M+9
MG: 30

WEM = Tray installation dim. (000)
M = installation dimension Centre glass (001)
Please always specify when ordering.

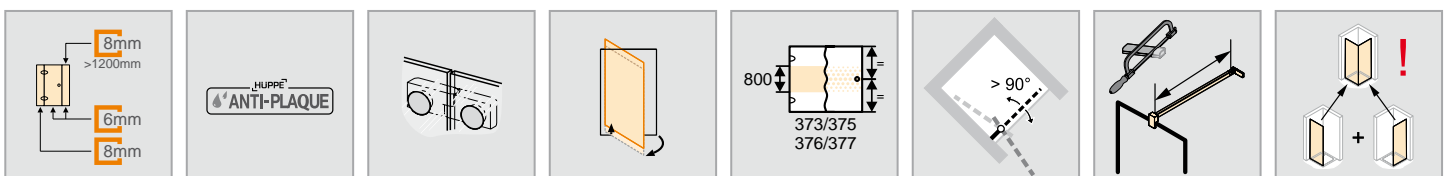

Swing door with fixed segment, plus additional section for side panel

Right-hand fixing

Installation on shower tray recommended

Height	Model	WEM	M (middle of glass)	Width of fixed segment	Width additional section	Entry width	Product no.	Base price
2000	1100	1075-1105	1045-1075	268-283	241-256	550	ST1701	1.815,-
	1200	1175-1205	1145-1175	268-283	241-256	650	ST1702	
	1300	1275-1305	1245-1275	268-283	241-256	750	ST1703	
	1400	1375-1405	1345-1375	368-383	341-356	750	ST1704	
	1500	1475-1505	1445-1475	368-383	341-356	850	ST1705	
	1600	1575-1605	1545-1575	368-383	341-356	850	ST1711	2.145,-
	1700	1675-1705	1645-1675	468-483	441-456	850	ST1712	2.325,-
	1800	1775-1805	1745-1775	468-483	441-456	850	ST1713	

Right-hand fixing

Floor-flush installation recommended

Height	Model	M (middle of glass)	Width of fixed segment	Width additional section	Entry width	Product no.	Base price
2000	1100	1085-1115	272-287	246-270	550	ST1706	1.815,-
	1200	1185-1215	272-287	246-270	650	ST1707	
	1300	1285-1315	272-287	246-270	750	ST1708	
	1400	1385-1415	372-387	346-370	750	ST1709	
	1500	1485-1515	372-387	346-370	850	ST1710	
	1600	1585-1615	372-387	346-370	850	ST1714	2.145,-
	1700	1685-1715	472-487	446-470	850	ST1715	2.325,-
	1800	1785-1815	472-487	446-470	850	ST1716	

Made-to-measure - Right-hand fixing

Height	Width of door front	Product no.	Base price
1200-2000	900-1200	ST1780	2.304,-
	1201-3300	ST1782	2.632,-
2001-2200	900-1200	ST1781	2.578,-
	1201-3300	ST1783	2.905,-





Adjustment range = dimensions - 15mm / + 15mm

The width of the fixed segment and additional section must be stated.

Slopes and cut-outs

Slopes and cut-outs	Extra charges
	Supplement per slope/cut-out for made-to-measure 170,-

Dim. Range: min. - max.

				
1200-2200	900-3300	200-600	max. 900	200-1800

Extras

Height	Profile	Product no.	Price
2000	15mm extension profile for fixed segment, recess profile or additional section	ST7003	32,-

Special options

Optional variants	Extra charges
F-solution stabilizer, complete (solid wall/glass/glass/glass) up to 2000mm x 150mm x 150mm	 928 312,-

Colours - Panel options

Profile colours	Colour code	Extra charges	Panel options		without Anti-Plaque		with Anti-Plaque	
			Glass code	Extra charges	Glass code	Extra charges		
Silver high-gloss	092	0,-	Clear	321	0,-	322	418,-	
			Grey	301		368		
			Bronze	341	371,-	378	789,-	
			Sand Plus	315		316		
			Privatima	373		375		
			Bubbles	376		377		
			Mirror glass	380	439,-	381	857,-	

HÜPPE Solva pure partially framed Rectangular

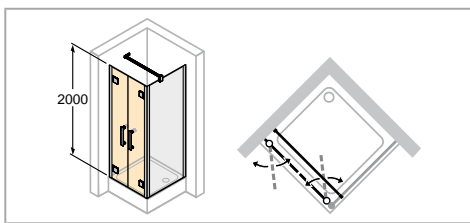

- Mirror glass (380/381): Please state in your order which segment should be produced with mirror glass. If this is not stated, the entire unit will be produced with mirror glass.
- For technical information, see Profile Colours and Panel Options section.

	<p>Dimensions</p> <p>WL: 31 R: 12 Mx: M+18 MG: 30</p>
<p>WEM = Tray installation dim. (000) M = installation dimension Centre glass (001) Please always specify when ordering.</p>	

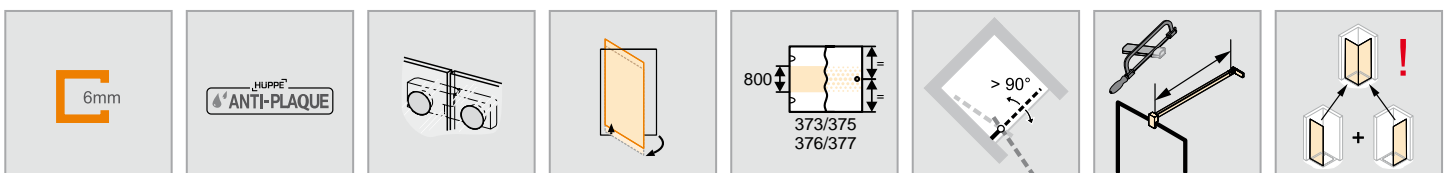

Two-way door for side panel

Installation on shower tray recommended

Height	Model	WEM	M (middle of glass)	Entry width	Product no.	Base price
2000	800	775-805	745-775	612	ST4101	1.847,-
	900	875-905	845-875	712	ST4102	
	1000	975-1005	945-975	812	ST4103	1.938,-
	1100	1075-1105	1045-1075	912	ST4107	
	1200	1175-1205	1145-1175	1012	ST4108	

Floor-flush installation recommended



Height	Model	M (middle of glass)	Entry width	Product no.	Base price
2000	800	785-815	642	ST4104	1.847,-
	900	885-915	742	ST4105	
	1000	985-1015	842	ST4106	1.938,-
	1100	1085-1105	942	ST4109	
	1200	1185-1205	1042	ST4110	

Made-to-measure

Height	Width Door front	Product no.	Base price
1200-2000	600-1200	ST4180	2.344,-
2001-2200	600-1200	ST4181	2.618,-

Adjustment range = dimensions - 15mm / + 15mm

Dim. Range: min. - max.

	
1200-2200	600-1200

Extras

Height	Product no.	Price
2000	15mm extension profile, hinge side ST7001	32,-

Colours - Panel options

Profile colours	Colour code	Extra charges	Panel options	without Anti-Plaque		with Anti-Plaque	
				Glass code	Extra charges	Glass code	Extra charges
Silver high-gloss	092	0,-	Clear	321	0,-	322	209,-
			Grey	301		368	
			Bronze	341		378	
			Sand Plus	315	186,-	316	395,-
			Privatima	373		375	
			Bubbles	376		377	
			Mirror glass	380	439,-	381	648,-

HÜPPE Solva pure partially framed Rectangular

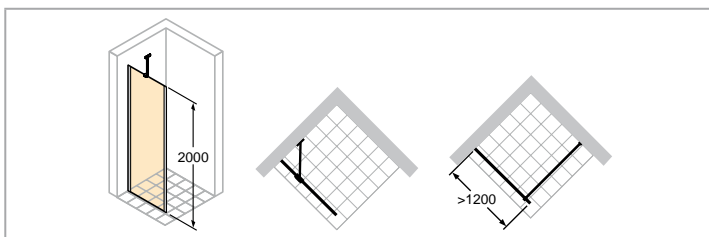

- Shortened side panel can only be combined with door in recess.
- Towel rail height can be selected individually and must be specified with the order. If nothing is specified, the towel rail is always delivered middle of glass (height and width).

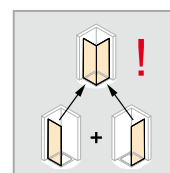
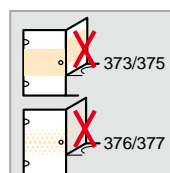
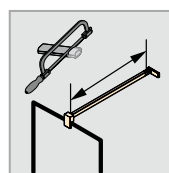
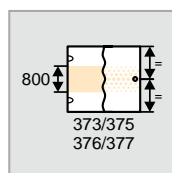
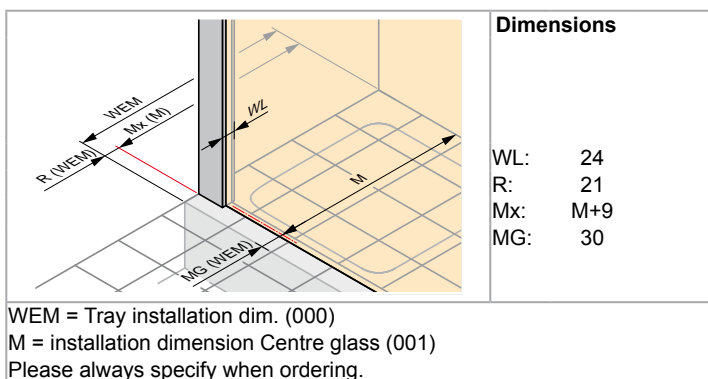

Side panel for swing door with additional section/Swing door with fixed segment and additional section/Two-way door

Left-hand fixing

Installation on shower tray recommended

Height	Model	WEM	M (middle of glass)	Product no.	Base price
2000	SW 700	690-705	660-675	ST5001	984,-
	SW 750	740-755	710-725	ST5002	
	SW 800	790-805	760-775	ST5003	
	SW 900	890-905	860-875	ST5004	
	SW 1000	990-1005	960-975	ST5005	1.033,-
	SW 1200	1190-1205	1160-1175	ST5006	1.053,-

Left-hand fixing

Floor-flush installation recommended

Height	Model	M (middle of glass)	Product no.	Base price
2000	SW 700	692-707	ST5012	984,-
	SW 750	742-757	ST5013	
	SW 800	792-807	ST5014	
	SW 900	892-907	ST5015	
	SW 1000	992-1007	ST5016	1.033,-
	SW 1200	1192-1207	ST5017	1.053,-

Made-to-measure - Left-hand fixing



Height	Model	Width	Product no.	Base price
1200-2000	Standard made-to-measure	200-1200	ST5080	1.248,-
	Standard made-to-measure	1201-1800	ST5082	1.576,-
2001-2200	Standard made-to-measure	200-1200	ST5081	1.522,-
	Standard made-to-measure	1201-1800	ST5083	1.850,-
1200-2000	On bathtub	200-1200	ST5084	1.248,-
	On bathtub	1201-1800	ST5086	1.576,-

Adjustment range = dimensions - 8mm / + 7mm

Slopes and cut-outs

Slopes and cut-outs	Extra charges
 Supplement per slope/cut-out for made-to-measure	170,-

Dim. Range: min. - max.

	
1200-2200	200-1800

Extras

Height	Profile	Product no.	Price
2000	15mm extension profile for fixed segment, recess profile or additional section	 ST7003	32,-

Special options

Special options	Extra charges
Towel rail (silver high-gloss)	T99 210,-

Colours - Panel options

Profile colours	Colour code	Extra charges	Panel options		without Anti-Plaque		with Anti-Plaque	
			Glass code	Extra charges	Glass code	Extra charges		
Silver high-gloss	092	0,-	Clear	321	0,-	322	209,-	
			Grey	301		368		
			Bronze	341	186,-	378	395,-	
			Sand Plus	315		316		
			Privatima	373		375		
			Bubbles	376		377		
			Mirror glass	380	439,-	381	648,-	

HÜPPE Solva pure partially framed Rectangular

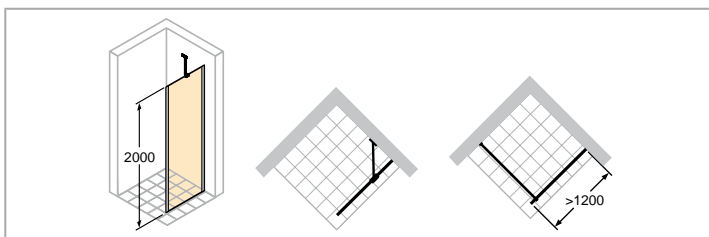

- Shortened side panel can only be combined with door in recess.
- Towel rail height can be selected individually and must be specified with the order. If nothing is specified, the towel rail is always delivered middle of glass (height and width).

Dimensions

WL: 24
R: 21
Mx: M+9
MG: 30

WEM = Tray installation dim. (000)
M = installation dimension Centre glass (001)
Please always specify when ordering.

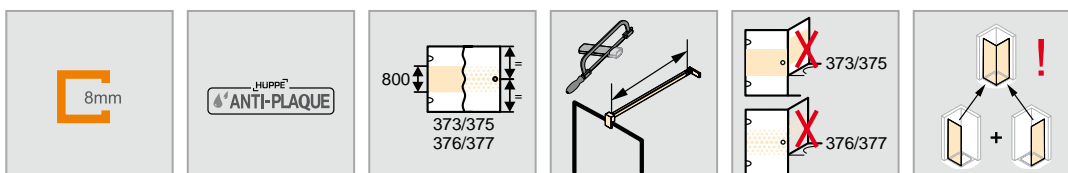

Side panel for swing door with additional section/Swing door with fixed segment and additional section/Two-way door

Right-hand fixing

Installation on shower tray recommended

Height	Model	WEM	M (middle of glass)	Product no.	Base price
2000	SW 700	690-705	660-675	ST5101	984,-
	SW 750	740-755	710-725	ST5102	
	SW 800	790-805	760-775	ST5103	
	SW 900	890-905	860-875	ST5104	
	SW 1000	990-1005	960-975	ST5105	1.033,-
	SW 1200	1190-1205	1160-1175	ST5106	1.053,-

Right-hand fixing

Floor-flush installation recommended

Height	Model	M (middle of glass)	Product no.	Base price
2000	SW 700	692-707	ST5112	984,-
	SW 750	742-757	ST5113	
	SW 800	792-807	ST5114	
	SW 900	892-907	ST5115	
	SW 1000	992-1007	ST5116	1.033,-
	SW 1200	1192-1207	ST5117	1.053,-

Made-to-measure - Right-hand fixing



Height	Model	Width	Product no.	Base price
1200-2000	Standard made-to-measure	200-1200	ST5180	1.248,-
	Standard made-to-measure	1201-1800	ST5182	1.576,-
2001-2200	Standard made-to-measure	200-1200	ST5181	1.522,-
	Standard made-to-measure	1201-1800	ST5183	1.850,-
1200-2000	On bathtub	200-1200	ST5184	1.248,-
	On bathtub	1201-1800	ST5186	1.576,-

Adjustment range = dimensions - 8mm / + 7mm

Slopes and cut-outs

Slopes and cut-outs	Extra charges
 Supplement per slope/cut-out for made-to-measure	170,-

Dim. Range: min. - max.

	
1200-2200	200-1800

Extras

Height	Profile	Product no.	Price
2000	15mm extension profile for fixed segment, recess profile or additional section 	ST7003	32,-

Special options

Special options	Extra charges
Towel rail (silver high-gloss)	T99 210,-

Colours - Panel options

Profile colours	Colour code	Extra charges	Panel options		without Anti-Plaque		with Anti-Plaque	
			Glass code	Extra charges	Glass code	Extra charges		
Silver high-gloss	092	0,-	Clear	321	0,-	322	209,-	
			Grey	301		368		
			Bronze	341	186,-	378		
			Sand Plus	315		316	395,-	
			Privatima	373		375		
			Bubbles	376		377		
			Mirror glass	380	439,-	381	648,-	

HÜPPE Solva pure partially framed Rectangular

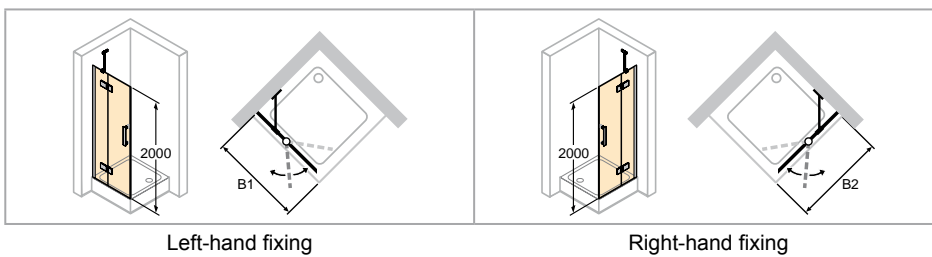

Left-hand fixing

Right-hand fixing

- Mirror glass (380/381): Please state in your order which segment should be produced with mirror glass. If this is not stated, the entire unit will be produced with mirror glass.
- For technical information, see Profile Colours and Panel Options section.

Dimensions	
	<p>WL: 24</p> <p>R: 21</p> <p>Mx: M+9</p> <p>MG: 30</p>
<p>WEM = Tray installation dim. (000)</p> <p>M = installation dimension Centre glass (001)</p> <p>Please always specify when ordering.</p>	

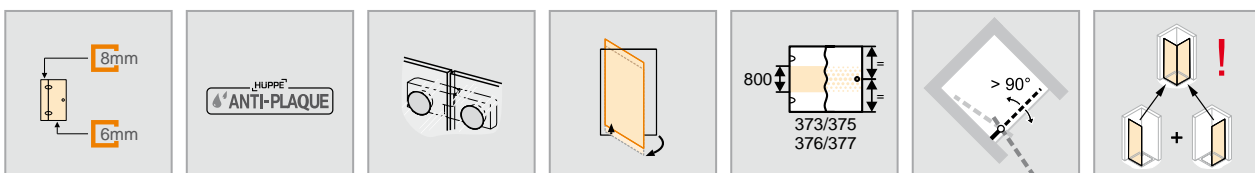

Swing door with fixed segment for corner entry

Installation on shower tray recommended

Height	Model	WEM B1/B2	M (middle of glass) B1/B2	Width of fixed segment	Entry width	Left-hand fixing Product no.	Right-hand fixing Product no.	Base price
2000	800	790-805	760-775	290-305	649	ST1101	ST1201	1.609,-
	900	890-905	860-875	290-305	791	ST1102	ST1202	
	1000	990-1005	960-975	390-405	932	ST1103	ST1203	1.689,-
	1200	1190-1205	1160-1175	390-405	1073	ST1107	ST1207	1.721,-

NOTE: The complete corner entry consists of two item nos.

Floor-flush installation recommended

Height	Model	M (middle of glass) B1/B2	Width of fixed segment	Entry width	Left-hand fixing Product no.	Right-hand fixing Product no.	Base price
2000	800	792-807	322-337	649	ST1104	ST1204	1.609,-
	900	892-907	322-337	791	ST1105	ST1205	
	1000	992-1007	422-437	932	ST1106	ST1206	1.689,-
	1200	1192-1207	422-437	1073	ST1108	ST1208	1.721,-

NOTE: The complete corner entry consists of two item nos.

Made-to-measure

Height	Width Door front	Left-hand fixing Product no.	Right-hand fixing Product no.	Base price
1200-2000	700-1200	ST1180	ST1280	2.045,-
	1201-1500	ST1182	ST1282	2.414,-
2001-2200	700-1200	ST1181	ST1281	2.353,-
	1201-1500	ST1183	ST1283	2.722,-





Adjustment range = dimensions - 8mm / + 7mm

The width of the fixed segment must be stated.

Slopes and cut-outs

Slopes and cut-outs	Extra charges
	Supplement per slope/cut-out for made-to-measure 170,-

Dim. Range: min. - max.

			
1200-2200	700-1500	200-600	max. 900

Extras

Height	Profile	Product no.	Price
2000	15mm extension profile for fixed segment, recess profile or additional section	 ST7003	32,-

Colours - Panel options

Profile colours	Colour code	Extra charges	Panel options		without Anti-Plaque		with Anti-Plaque	
			Glass code	Extra charges	Glass code	Extra charges		
Silver high-gloss	092	0,-	Clear	321	0,-	322	209,-	
			Grey	301		368		
			Bronze	341	186,-	378	395,-	
			Sand Plus	315		316		
			Privatima	373		375		
			Bubbles	376		377		
			Mirror glass	380	439,-	381	648,-	

HÜPPE Solva pure partially framed Rectangular

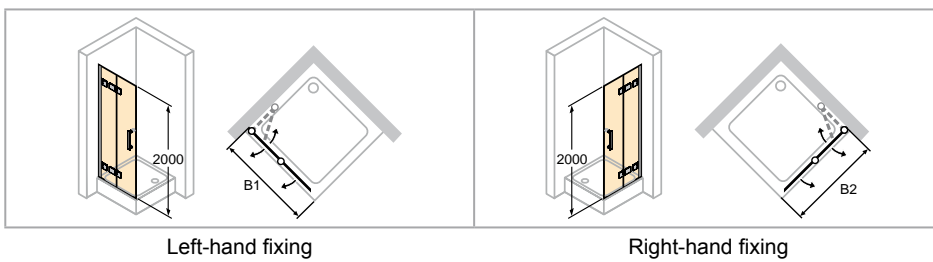

- Mirror glass (380/381): Please state in your order which segment should be produced with mirror glass. If this is not stated, the entire unit will be produced with mirror glass.
- For technical information, see Profile Colours and Panel Options section.

	<p>Dimensions</p> <p>WL: 31 R: 12 Mx: M+18 MG: 30</p>
<p>WEM = Tray installation dim. (000) M = installation dimension Centre glass (001) Please always specify when ordering.</p>	

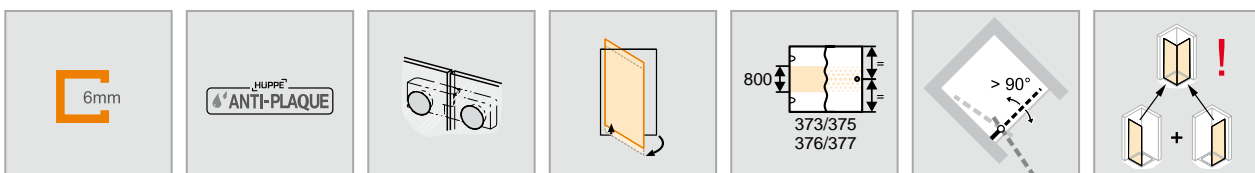

Folding swing door for corner entry

Installation on shower tray recommended

Height	Model	WEM B1/B2	M (middle of glass) B1/B2	Folded width F	Profile thickness P	Entry width	Left-hand fixing Product no.	Right-hand fixing Product no.	Base price
2000	700	690-705	660-675	326	95-110	836	ST4701	ST5201	1.569,-
	750	740-755	710-725	351	95-110	907	ST4702	ST5202	
	800	790-805	760-775	376	95-110	977	ST4703	ST5203	
	900	890-905	860-875	426	95-110	1119	ST4704	ST5204	1.648,-
	1000	990-1005	960-975	476	95-110	1260	ST4705	ST5205	1.679,-
	1200	1190-1205	1160-1175	576	95-110	1543	ST4706	ST5206	1.679,-

NOTE: The complete corner entry consists of two item nos.

Floor-flush installation recommended

Height	Model	M (middle of glass) B1/B2	Folded width F	Profile thickness P	Entry width	Left-hand fixing Product no.	Right-hand fixing Product no.	Base price
2000	700	692-707	342	95-110	878	ST4707	ST5207	1.569,-
	750	742-757	367	95-110	949	ST4708	ST5208	
	800	792-807	392	95-110	1020	ST4709	ST5209	
	900	892-907	442	95-110	1161	ST4710	ST5210	1.648,-
	1000	992-1007	492	95-110	1302	ST4711	ST5211	1.679,-
	1200	1192-1207	592	95-110	1585	ST4712	ST5212	1.679,-

NOTE: The complete corner entry consists of two item nos.

Made-to-measure

Height	Width Door front	Left-hand fixing Product no.	Right-hand fixing Product no.	Base price
1200-2000	500-1250	ST4780	ST5280	1.994,-

Adjustment range = dimensions - 8mm / + 7mm

Slopes and cut-outs

Slopes and cut-outs	Extra charges
	Supplement per slope/cut-out for made-to-measure 170,-

Dim. Range: min. - max.

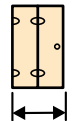
	
1200-2000	500-1250

Extras

Height	Product no.	Price
2000	15mm extension profile, hinge side ST7001	32,-

Colours - Panel options

Profile colours	Colour code	Extra charges	Panel options	without Anti-Plaque		with Anti-Plaque	
				Glass code	Extra charges	Glass code	Extra charges
Silver high-gloss	092	0,-	Clear	321	0,-	322	209,-
			Grey	301		368	
			Bronze	341		378	
			Sand Plus	315	186,-	316	395,-
			Privatima	373		375	
			Bubbles	376		377	
			Mirror glass	380	439,-	381	648,-

HÜPPE Solva pure partially framed Quadrant

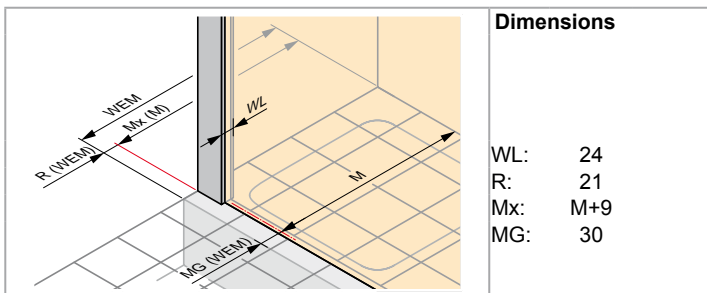
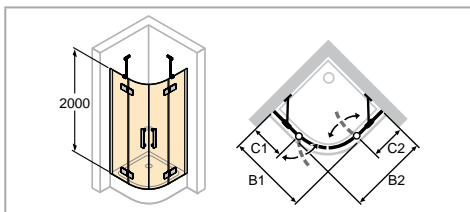

WEM = Tray installation dim. (000)
 M = installation dimension Centre glass (001)
 Please always specify when ordering.

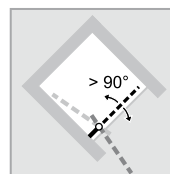
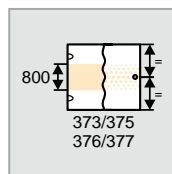
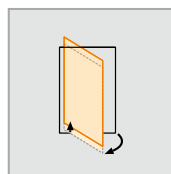
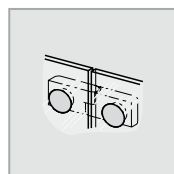
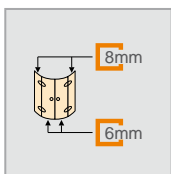

Swing door with fixed segments, 2-panel

Height	Model B1/B2	WEM B1	WEM B2	M (middle of glass) B1	M (middle of glass) B2	Width panel C1	Width panel C2	Entry width	Radius	Product no.	Base price
2000	900 x 900	890-905	890-905	860-875	860-875	271-286	271-286	819	500	ST1801	2.854,-
	1000 x 1000	990-1005	990-1005	960-975	960-975	371-386	371-386	819	500	ST1802	2.996,-
	900 x 1000	890-905	990-1005	860-875	960-975	271-286	371-386	819	500	ST1803	
	1000 x 900	990-1005	890-905	960-975	860-875	371-386	271-286	819	500	ST1804	
	900 x 1200	890-905	1190-1205	860-875	1160-1175	271-286	571-586	819	500	ST1805	3.053,-
	1200 x 900	1190-1205	890-905	1160-1175	860-875	571-586	271-286	819	500	ST1806	
	900 x 900	890-905	890-905	860-875	860-875	224-239	224-239	885	550	ST1807	2.854,-
	1000 x 1000	990-1005	990-1005	960-975	960-975	324-339	324-339	885	550	ST1808	2.996,-

Made-to-measure



Height	Width B1	Width B2	Radius	Product no.	Base price
2000	900-1200	900-1200	500	ST1880	3.624,-
	900-1200	900-1200	550	ST1881	

Adjustment range = dimensions - 8mm / + 7mm

Slopes and cut-outs

Slopes and cut-outs	Extra charges
 <p>Supplement per slope/cut-out for made-to-measure</p>	170,-

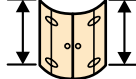
Dim. Range: min. - max.

		
2000	900-1200	900-1200

Extras

Height	Profile	Product no.	Price
2000	15mm extension profile for fixed segment, recess profile or additional section	 ST7003	32,-

Colours - Panel options

Profile colours	Colour code	Extra charges	Panel options		without Anti-Plaque		with Anti-Plaque	
			Glass code	Extra charges	Glass code	Extra charges		
Silver high-gloss	092	0,-	Clear	321	0,-	322	418,-	
			Privatima	373	371,-	375	789,-	
			Bubbles	376		377		

HÜPPE Solva pure partially framed Quadrant

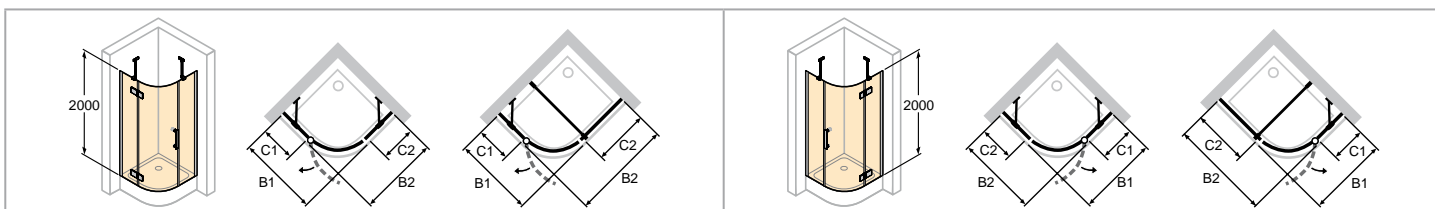

Left-hand fixing

Additional section width > 600mm delivered with cross-bracing

Right-hand fixing

Additional section width > 600mm delivered with cross-bracing

- The fixed segments on the door side are installed with a tilt of 5mm (at the top) towards the outside.

	<p>Dimensions</p> <p>WL: 24 R: 21 Mx: M+9 MG: 30</p>
<p>WEM = Tray installation dim. (000) M = installation dimension Centre glass (001) Please always specify when ordering.</p>	

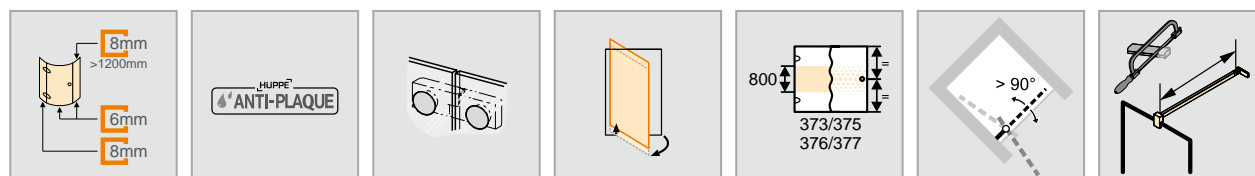

Swing door with fixed segments, 1-panel

Height	Model B1/B2	WEM B1/B2	M (middle of glass) B1/B2	C2	C1	Entry width	Radius	Left-hand fixing Product no.	Right-hand fixing Product no.	Base price
2000	900 x 900	890-905	860-875	269-284	378-393	754	500	ST1901	ST2001	2.854,-
	1000 x 1000	990-1005	960-975	369-384	478-493	754	500	ST1902	ST2002	2.996,-
	900 x 900	890-905	860-875	224-239	332-347	819	550	ST1907	ST2007	2.854,-
	1000 x 1000	990-1005	960-975	324-339	432-447	819	550	ST1908	ST2008	2.996,-

Made-to-measure

Height	Width B1	Width B2	Radius	Left-hand fixing Product no.	Right-hand fixing Product no.	Base price
2000	900-1200	900-1200	500	ST1980	ST2080	3.199,-
	900-1200	1201-2300	500	ST1981	ST2081	3.855,-
	900-1200	900-1200	550	ST1982	ST2082	3.199,-
	900-1200	1201-2300	550	ST1983	ST2083	3.855,-

Adjustment range = dimensions - 8mm / + 7mm

Slopes and cut-outs

Slopes and cut-outs	Extra charges
 <p>Supplement per slope/cut-out for made-to-measure</p>	170,-

Dim. Range: min. - max.

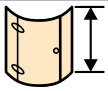
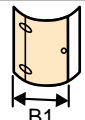
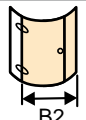
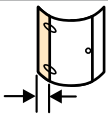
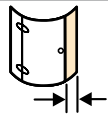
				
2000	900-1200	900-2300	200-600	200-1800

Extras

Height	Profile	Product no.	Price
2000	15mm extension profile for fixed segment, recess profile or additional section	 ST7003	32,-

Colours - Panel options

Profile colours	Colour code	Extra charges	Panel options				
			without Anti-Plaque Glass code	with Anti-Plaque Glass code			
Silver high-gloss	092	0,-	Clear	321	0,-	322	418,-
			Privatima	373	371,-	375	789,-
			Bubbles	376		377	

HÜPPE Solva pure partially framed Pentagonal

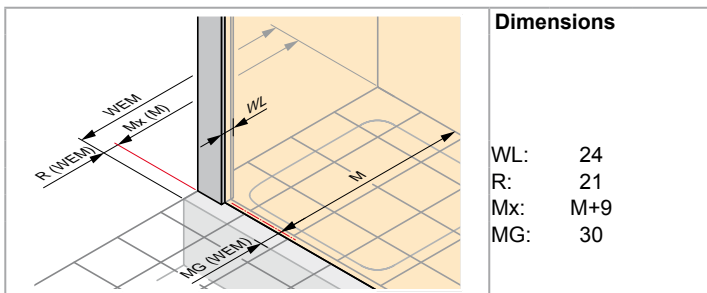
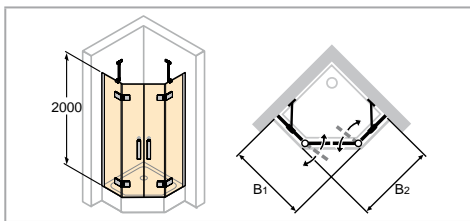

WEM = Tray installation dim. (000)
 M = installation dimension Centre glass (001)
 Please always specify when ordering.

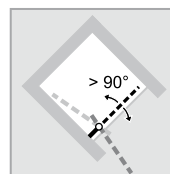
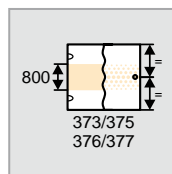
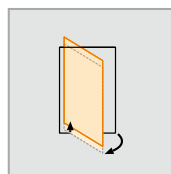
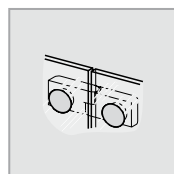
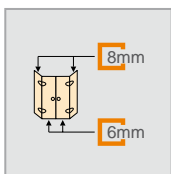

Swing door with fixed segments, 2-panel

Height	Model B1/B2	WEM	M (middle of glass)	Width of fixed segment	Entry width	Product no.	Base price
2000	900 x 900	890-905	860-875	440-455	580	ST4001	2.854,-
	1000 x 1000	990-1005	960-975	490-505	650	ST4002	2.996,-

Made-to-measure



Height	Width B1	Width B2	Product no.	Base price
1200-2000	700-1200	700-1200	ST4080	3.624,-
	700-1200	1201-1870	ST4082	4.280,-
	1201-1870	1201-1870		
2001-2200	700-1200	700-1200	ST4081	4.171,-
	700-1200	1201-1870	ST4083	4.828,-
	1201-1870	700-1200		
	1201-1870	1201-1870		

Adjustment range = dimensions - 8mm / + 7mm

Slopes and cut-outs

Slopes and cut-outs	Extra charges
	Supplement per slope/cut-out for made-to-measure
	170,-

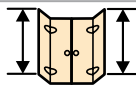
Dim. Range: min. - max.

		
1200-2200	700-1870	700-1870

Extras

Height	Profile	Product no.	Price
2000	15mm extension profile for fixed segment, recess profile or additional section	 ST7003	32,-

Colours - Panel options

Profile colours	Colour code	Extra charges	Panel options		without Anti-Plaque		with Anti-Plaque	
			Glass code	Extra charges	Glass code	Extra charges		
Silver high-gloss	092	0,-	Clear	321	0,-	322	418,-	
			Sand Plus	315	371,-	316	789,-	
			Privatima	373		375		
			Bubbles	376		377		

HÜPPE Solva pure partially framed Pentagonal

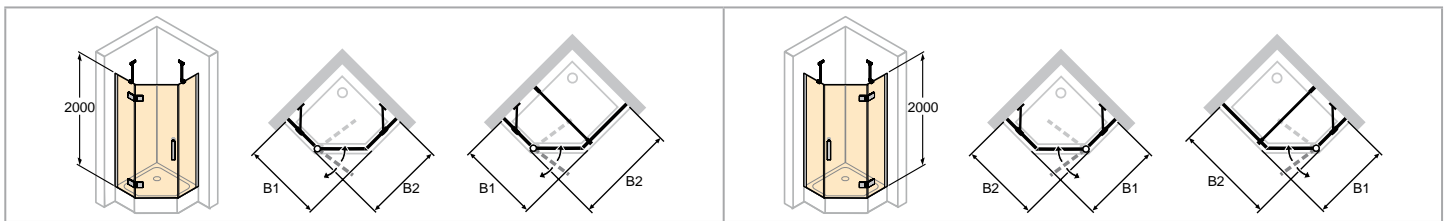

Left-hand fixing

Additional section width > 600mm delivered with cross-bracing

Right-hand fixing

Additional section width > 600mm delivered with cross-bracing

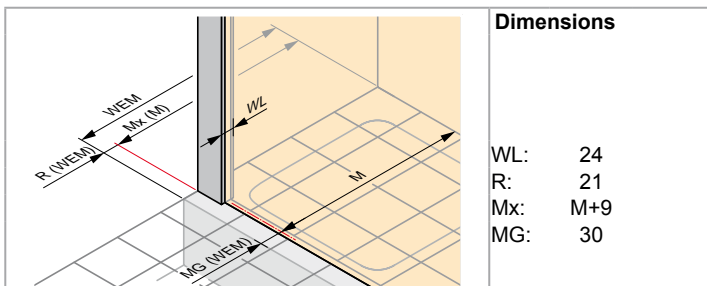

WEM = Tray installation dim. (000)
 M = installation dimension Centre glass (001)
 Please always specify when ordering.

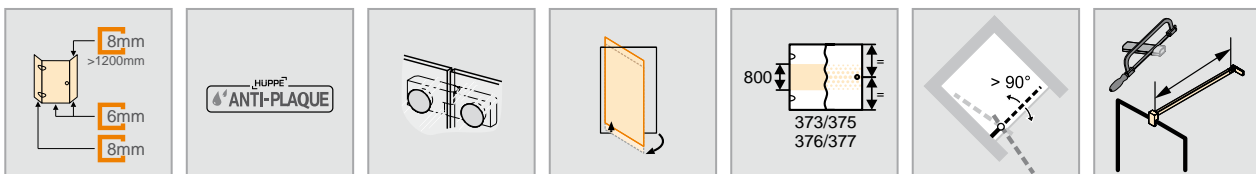

Swing door with fixed segments, 1-panel

Height	Model B1/B2	WEM	M (middle of glass)	Width of fixed segment	Entry width	Left-hand fixing Product no.	Right-hand fixing Product no.	Base price
2000	900 x 900	890-905	860-875	440-455	596	ST3801	ST3901	2.854,-
	1000 x 1000	990-1005	960-975	490-505	667	ST3802	ST3902	2.996,-

Made-to-measure



Height	Width B1	Width B2	Left-hand fixing Product no.	Right-hand fixing Product no.	Base price
1200-2000	700-1200	700-1200	ST3880	ST3980	3.199,-
	700-1200	1201-2430	ST3882	ST3982	3.855,-
	1201-1230	1201-2430			
2001-2200	700-1200	700-1200	ST3881	ST3981	3.745,-
	700-1200	1201-2430	ST3883	ST3983	4.402,-
	1201-1230	1201-2430			

Adjustment range = dimensions - 8mm / + 7mm

Slopes and cut-outs

Slopes and cut-outs	Extra charges
	Supplement per slope/cut-out for made-to-measure 170,-

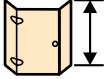
Dim. Range: min. - max.

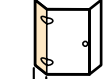
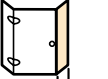
				
1200-2200	700-1230	700-2430	200-600	200-1800

Extras

Height	Profile	Product no.	Price
2000	15mm extension profile for fixed segment, recess profile or additional section	 ST7003	32,-

Colours - Panel options

Profile colours	Colour code	Extra charges	Panel options				
			without Anti-Plaque Glass code	with Anti-Plaque Glass code			
Silver high-gloss	092	0,-	Clear	321	0,-	322	418,-
			Sand Plus	315		316	
			Privatima	373	371,-	375	789,-
			Bubbles	376		377	

HÜPPE Solva pure partially framed Rectangular

Swing door, rectangular U-shaped enclosure

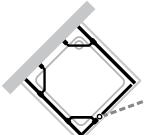
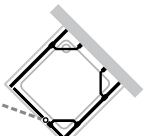
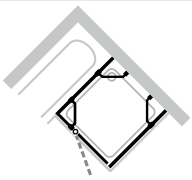
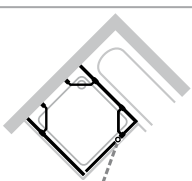
Height	Width	Consisting of:	For ...	Product no.	Price
1200-2000	700-1500	1 swing door with fixed segment for side panel, left		ST8080	3.797,-
1200-2000	200-1800	1 side panel for swing door/folding swing door/swing door with fixed segment, right			
1200-2000	200-1800	1 side panel for swing door with additional section/swing door with fixed segment and additional section/two-way door, left			
1200-2000	700-1500	1 swing door with fixed segment for side panel, right		ST8081	3.797,-
1200-2000	200-1800	1 side panel for swing door/folding swing door/swing door with fixed segment, left			
1200-2000	200-1800	1 side panel for swing door with additional section/swing door with fixed segment and additional section/two-way door, right			
1200-2000	700-1500	1 swing door with fixed segment for side panel, left		ST8082	3.797,-
1200-2000	700-1500	1 side panel for swing door/folding swing door/swing door with fixed segment, right			
1200-2000	200-1800	1 short side panel for swing door with additional section/swing door with fixed segment and additional section/two-way door, left			
1200-2000	700-1500	1 swing door with fixed segment for side panel, right		ST8083	3.797,-
1200-2000	700-1500	1 side panel for swing door/folding swing door/swing door with fixed segment, left			
1200-2000	200-1800	1 short side panel for swing door with additional section/swing door with fixed segment and additional section/two-way door, right			

It must be stated whether the specified dimensions refer to the tray installation dimensions or the middle glass installation dimensions (e.g. floor-flush).
 The following therefore needs to be specified in the order with respect to dimensions:
 Refers to the tray installation dimensions: 000
 Refers to the middle glass installation dimensions: 001

Colours - Panel options

Profile colours	Colour code	Extra charges
Silver high-gloss	092	0,-

Panel options	without Anti-Plaque		with Anti-Plaque	
	Glass code	Extra charges	Glass code	Extra charges
Clear	321	0,-	322	418,-
Grey	301		368	
Bronze	341		378	
Sand Plus	315	371,-	316	789,-
Privatima	373		375	
Bubbles	376		377	
Mirror glass	380	439,-	381	857,-

Swing door, rectangular U-shaped enclosure

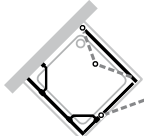
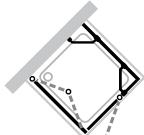
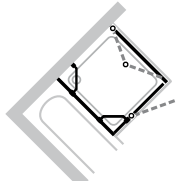
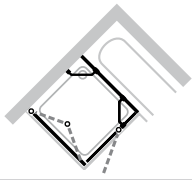
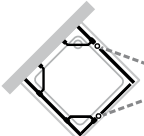
Height	Width	Consisting of:	For ...	Product no.	Price
1400-2000 1200-2000 1200-2000	500-1250 700-1500 200-1800	1 folding swing door for corner entry, right 1 swing door with fixed segment for corner entry, left 1 side panel for swing door with additional section/swing door with fixed segment and additional section/two-way door, left		ST8280	4.404,-
1400-2000 1200-2000 1200-2000	500-1250 700-1500 200-1800	1 folding swing door for corner entry, left 1 swing door with fixed segment for corner entry, right 1 side panel for swing door with additional section/swing door with fixed segment and additional section/two-way door, right		ST8281	4.404,-
1400-2000 1200-2000 1200-2000	500-1250 700-1500 200-1800	1 folding swing door for corner entry, right 1 swing door with fixed segment for corner entry, left 1 short side panel for swing door with additional section/swing door with fixed segment and additional section/two-way door, left		ST8282	4.404,-
1400-2000 1200-2000 1200-2000	500-1250 700-1500 200-1800	1 folding swing door for corner entry, left 1 swing door with fixed segment for corner entry, right 1 short side panel for swing door with additional section/swing door with fixed segment and additional section/two-way door, right		ST8283	4.404,-
1200-2000 1200-2000 1200-2000	700-1500 700-1500 200-1800	1 swing door with fixed segment for corner entry, right 1 swing door with fixed segment for corner entry, left 1 side panel for swing door with additional section/swing door with fixed segment and additional section/two-way door		ST8380	4.609,-
It must be stated whether the specified dimensions refer to the tray installation dimensions or the middle glass installation dimensions (e.g. floor-flush).					
The following therefore needs to be specified in the order with respect to dimensions:					
Refers to the tray installation dimensions: 000					
Refers to the middle glass installation dimensions: 001					

Colours - Panel options

Profile colours	Colour code	Extra charges	Panel options	without Anti-Plaque		with Anti-Plaque	
				Glass code	Extra charges	Glass code	Extra charges
Silver high-gloss	092	0,-	Clear	321	0,-	322	418,-
			Grey	301		368	
			Bronze	341		378	
			Sand Plus	315	371,-	316	789,-
			Privatima	373		375	
			Bubbles	376		377	
			Mirror glass	380	439,-	381	857,-

HÜPPE Solva pure partially framed Rectangular

Swing door, rectangular U-shaped enclosure

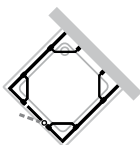
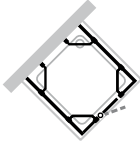
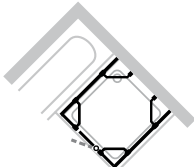
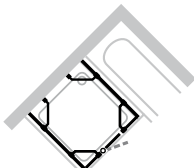
Height	Width	Consisting of:	For ...	Product no.	Price
1200-2000	900-3300	1 swing door with fixed segment and additional section for side panel, right		ST8580	4.272,-
1200-2000	200-1800	1 side panel for swing door with additional section/swing door with fixed segment and additional section/two-way door, right			
1200-2000	200-1800	1 side panel for swing door with additional section/swing door with fixed segment and additional section/two-way door, left			
1200-2000	900-3300	1 Swing door with fixed segment and additional section, left		ST8581	4.272,-
1200-2000	200-1800	1 side panel for swing door with additional section/swing door with fixed segment and additional section/two-way door, left			
1200-2000	200-1800	1 side panel for swing door with additional section/swing door with fixed segment and additional section/two-way door, right			
1200-2000	900-3300	1 Swing door with fixed segment and additional section, right		ST8582	4.272,-
1200-2000	200-1800	1 side panel for swing door with additional section/swing door with fixed segment and additional section/two-way door, right			
1200-2000	200-1800	1 short side panel for swing door with additional section/swing door with fixed segment and additional section/two-way door, left			
1200-2000	900-3300	1 Swing door with fixed segment and additional section, left		ST8583	4.272,-
1200-2000	200-1800	1 side panel for swing door with additional section/swing door with fixed segment and additional section/two-way door, left			
1200-2000	200-1800	1 short side panel for swing door with additional section/swing door with fixed segment and additional section/two-way door, right			

It must be stated whether the specified dimensions refer to the tray installation dimensions or the middle glass installation dimensions (e.g. floor-flush).
 The following therefore needs to be specified in the order with respect to dimensions:
 Refers to the tray installation dimensions: 000
 Refers to the middle glass installation dimensions: 001

Colours - Panel options

Profile colours	Colour code	Extra charges	Panel options		without Anti-Plaque		with Anti-Plaque	
			Glass code	Extra charges	Glass code	Extra charges		
Silver high-gloss	092	0,-	Clear	321	0,-	322	418,-	
			Grey	301		368		
			Bronze	341		378		
			Sand Plus	315	371,-	316	789,-	
			Privatima	373		375		
			Bubbles	376		377		
			Mirror glass	380	439,-	381	857,-	

HÜPPE Solva pure partially framed Rectangular

Two-way door, rectangular U-shaped enclosure

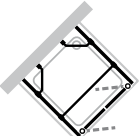
Height	Width	Consisting of:	For ...	Product no.	Price
1200-2000	600-1200	1 two-way door for side panel		ST8480	4.314,-
1200-2000	200-1800	1 side panel for swing door with additional section/swing door with fixed segment and additional section/two-way door, left			
1200-2000	200-1800	1 side panel for swing door with additional section/swing door with fixed segment and additional section/two-way door, right			

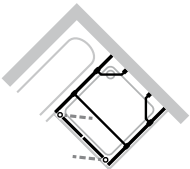
1200-2000	600-1200	1 two-way door for side panel		ST8481	4.314,-
1200-2000	200-1800	1 side panel for swing door with additional section/swing door with fixed segment and additional section/two-way door, right			
1200-2000	200-1800	1 short side panel for swing door with additional section/swing door with fixed segment and additional section/two-way door, left			

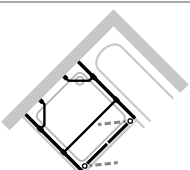
1200-2000	600-1200	1 two-way door for side panel		ST8482	4.314,-
1200-2000	200-1800	1 side panel for swing door with additional section/swing door with fixed segment and additional section/two-way door, left			
1200-2000	200-1800	1 short side panel for swing door with additional section/swing door with fixed segment and additional section/two-way door, right			

It must be stated whether the specified dimensions refer to the tray installation dimensions or the middle glass installation dimensions (e.g. floor-flush).

The following therefore needs to be specified in the order with respect to dimensions:

Refers to the tray installation dimensions: 000

Refers to the middle glass installation dimensions: 001

Colours - Panel options

Profile colours	Colour code	Extra charges	Panel options	without Anti-Plaque		with Anti-Plaque	
				Glass code	Extra charges	Glass code	Extra charges
Silver high-gloss	092	0,-	Clear	321	0,-	322	418,-
			Grey	301		368	
			Bronze	341		378	
			Sand Plus	315	371,-	316	789,-
			Privatima	373		375	
			Bubbles	376		377	
			Mirror glass	380	439,-	381	857,-

HÜPPE Solva pure partially framed Quadrant

Swing door, quadrant U-shaped enclosure

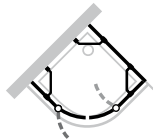
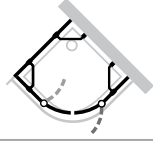
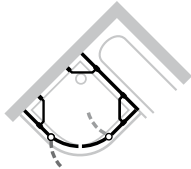
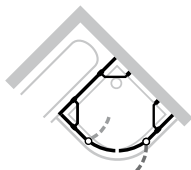
Height	Width	Consisting of:	For ...	Product no.	Price
2000 1200-2000	900-1200 200-1800	1 quadrant swing door with fixed segments, 2-panel, left 1 side panel for swing door with additional section/swing door with fixed segment and additional section/two-way door, right		ST8680	4.608,-
2000 1200-2000	900-1200 200-1800	1 quadrant swing door with fixed segments, 2-panel, right 1 side panel for swing door with additional section/swing door with fixed segment and additional section/two-way door, left		ST8681	4.608,-
2000 1200-2000	900-1200 200-1800	1 quadrant swing door with fixed segments, 2-panel, left 1 short side panel for swing door with additional section/swing door with fixed segment and additional section/two-way door, right		ST8682	4.608,-
2000 1200-2000	900-1200 200-1800	1 quadrant swing door with fixed segments, 2-panel, right 1 short side panel for swing door with additional section/swing door with fixed segment and additional section/two-way door, left		ST8683	4.608,-
It must be stated whether the specified dimensions refer to the tray installation dimensions or the middle glass installation dimensions (e.g. floor-flush).					
The following therefore needs to be specified in the order with respect to dimensions:					
Refers to the tray installation dimensions: 000					
Refers to the middle glass installation dimensions: 001					

Colours - Panel options

Profile colours	Colour code	Extra charges
Silver high-gloss	092	0,-

Panel options	without Anti-Plaque		with Anti-Plaque	
	Glass code	Extra charges	Glass code	Extra charges
Clear	321	0,-	322	418,-
Privatima	373	371,-	375	789,-
Bubbles	376		377	

Swing door, pentagonal U-shaped enclosure

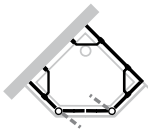
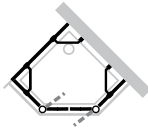
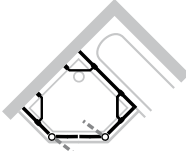
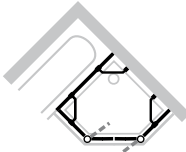
Height	Width	Consisting of:	For ...	Product no.	Price
1200-2000 1200-2000	700-1870 200-1800	1 pentagonal swing door with fixed segments, 2-panel, left 1 side panel for swing door with additional section/swing door with fixed segment and additional section/two-way door, right		ST8780	4.608,-
1200-2000 1200-2000	700-1870 200-1800	1 pentagonal swing door with fixed segments, 2-panel, right 1 side panel for swing door with additional section/swing door with fixed segment and additional section/two-way door, left		ST8781	4.608,-
1200-2000 1200-2000	700-1870 200-1800	1 pentagonal swing door with fixed segments, 2-panel, left 1 short side panel for swing door with additional section/swing door with fixed segment and additional section/two-way door, right		ST8782	4.608,-
1200-2000 1200-2000	700-1870 200-1800	1 pentagonal swing door with fixed segments, 2-panel, right 1 short side panel for swing door with additional section/swing door with fixed segment and additional section/two-way door, left		ST8783	4.608,-

It must be stated whether the specified dimensions refer to the tray installation dimensions or the middle glass installation dimensions (e.g. floor-flush).
The following therefore needs to be specified in the order with respect to dimensions:
Refers to the tray installation dimensions: 000
Refers to the middle glass installation dimensions: 001

Colours - Panel options

Profile colours	Colour code	Extra charges	Panel options		without Anti-Plaque		with Anti-Plaque	
			Glass code	Extra charges	Glass code	Extra charges		
Silver high-gloss	092	0,-	Clear	321	0,-	322	418,-	
			Sand Plus	315		316		
			Privatima	373	371,-	375	789,-	
			Bubbles	376		377		

HÜPPE Xtensa pure



reddot award 2015
winner

interior
innovation
award
2015
Winner



Rectangular

Walk-In sliding door, 1-panel with fixed segment

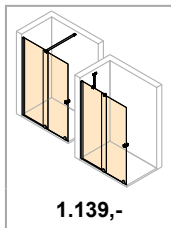

1.139,-

M.4-M.7

Side panel for Walk-In sliding door, 1-panel with fixed segment

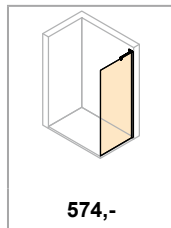

574,-

M.8-M.9

Sliding door, 2-section corner entry (1/2)

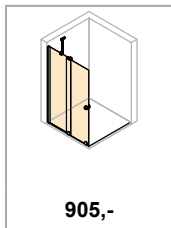

905,-

M.10-M.11

Sliding door, 2-panel with 2 fixed segments

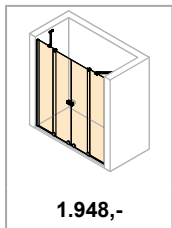

1.948,-

M.12-M.13

Side panel for sliding door, 2-panel with 2 fixed segments

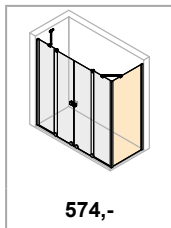

574,-

M.14-M.15

Sliding door, 1-panel with fixed segment and additional section

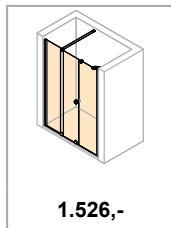

1.526,-

M.16-M.17

Side panel for sliding door, 1-panel with fixed segment and additional section

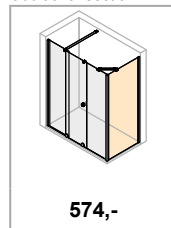

574,-

M.18-M.19

Bath-top shower screen

Sliding door, 1-panel with fixed segment

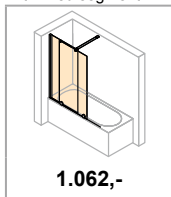

1.062,-

T.2-T.3

HÜPPE Xtensa pure



interior
innovation
award
2015
Winner



Product details



The functional design of the purist designer handle enables maximum opening of the sliding door for a wide entrance area



The high quality polished stainless steel rollers are screwed on flush on the interior, can be adjusted in height and enable easy cleaning.

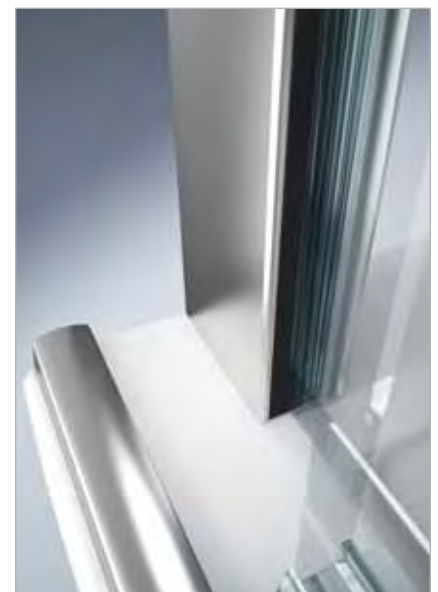

The doors for the Xtensa series are fitted with an especially thin wall profile. This makes the wall connection especially slim.



Cross bar can be shortened as required
Length: 1250mm

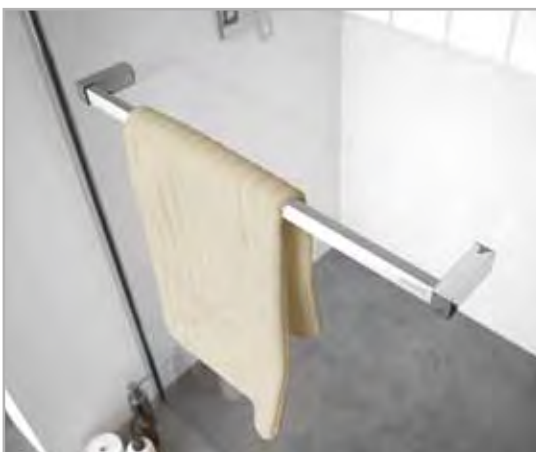

Towel rail in brushed silver for all side panels. If you order the towel rail as a special option, it is screw-fitted to the side panel. For a subsequent installation the towel rail can be ordered as an accessory (bonded installation).

HÜPPE Xtensa pure Rectangular

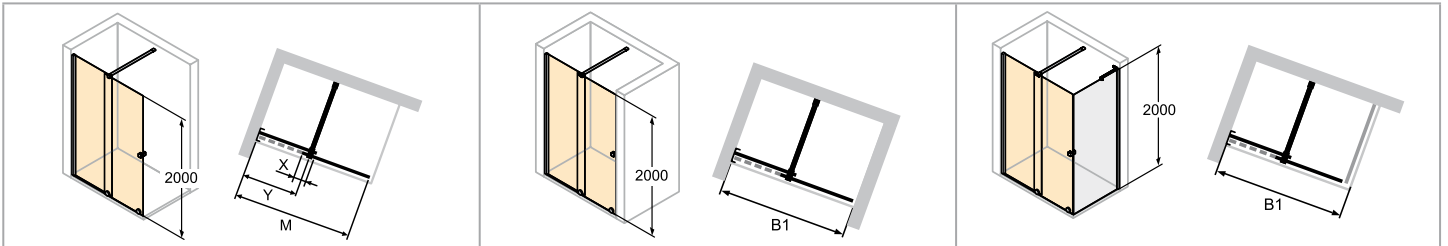

Walk-In
Left-hand fixing
Cross bar

GTN
Cross bar

GTS
Cross bar

- Installation on tiled surfaces and shower trays possible. Minimum tray rim width or floor area required for installation: 50mm.
- T-solution supplement set as an alternative to cross-bracing, see chapter Accessories and others.
- An even/flat area of 50mm must be available.
- Installation in U-shape possible.
- Mirror glass (380/381): Please state in your order which segment should be produced with mirror glass. If this is not stated, the entire unit will be produced with mirror glass.
- For technical information, see Profile Colours and Panel Options section.

Made-to-measure: Not possible with glass 372/389 chrome decor element.

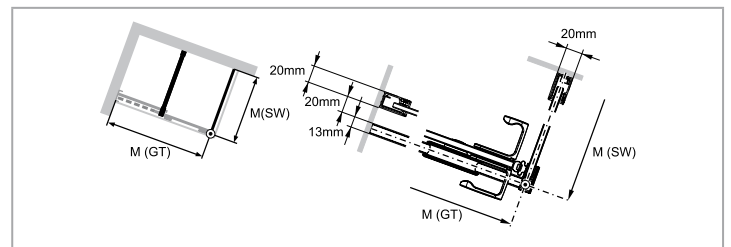
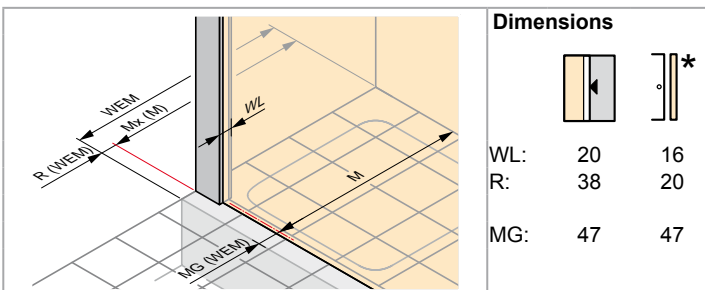

* = Profile for recess installation
 WEM = Tray installation dim. (000)
 M = Installation dimension middle of glass SW (001)
 Please always specify when ordering.

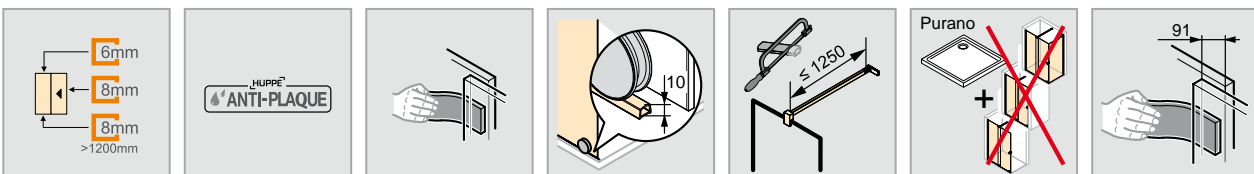

Walk-In sliding door, 1-panel with fixed segment

Left-hand fixing

Cross bar

Height	Model	Width M = Installation dimension as Walk-In	WEM GTN	WEM GTS	M GTN	M (middle of glass SW)	Min-max overlap glass panels X	Min-max entry width recess	Min. max. entry width with side panel	Cross bar installation dimension Y	Product no.	Base price	
2000	980-1000	968-1000	985-1017	1004-1036	985-1017	989-1021	91-110	402-421	383-402	516	XT0101	1.139,-	
	1001-1100	988-1100	1005-1117	1024-1136	1005-1117	1009-1121	91-190	372-471	353-452	566	XT0102		
	1101-1200	1088-1200	1105-1217	1124-1236	1105-1217	1109-1221	91-190	422-521	403-502	616	XT0103		1.221,-
	1201-1400	1188-1400	1205-1417	1224-1436	1205-1417	1209-1421	91-290	422-621	403-602	716	XT0105		1.339,-
	1401-1600	1388-1600	1405-1617	1424-1636	1405-1617	1409-1621	91-290	522-721	503-702	816	XT0107		1.454,-
	1601-1800	1588-1800	1605-1817	1624-1836	1605-1817	1609-1821	91-290	622-821	603-802	916	XT0109		1.570,-

Right-hand fixing

Cross bar

Height	Model	Width M = Installation dimension as Walk-In	WEM GTN	WEM GTS	M GTN	M (middle of glass SW)	Min-max overlap glass panels X	Min-max entry width recess	Min. max. entry width with side panel	Cross bar installation dimension Y	Product no.	Base price	
2000	980-1000	968-1000	985-1017	1004-1036	985-1017	989-1021	91-110	402-421	383-402	516	XT0201	1.139,-	
	1001-1100	988-1100	1005-1117	1024-1136	1005-1117	1009-1121	91-190	372-471	353-452	566	XT0202		
	1101-1200	1088-1200	1105-1217	1124-1236	1105-1217	1109-1221	91-190	422-521	403-502	616	XT0203		1.221,-
	1201-1400	1188-1400	1205-1417	1224-1436	1205-1417	1209-1421	91-290	422-621	403-602	716	XT0205		1.339,-
	1401-1600	1388-1600	1405-1617	1424-1636	1405-1617	1409-1621	91-290	522-721	503-702	816	XT0207		1.454,-
	1601-1800	1588-1800	1605-1817	1624-1836	1605-1817	1609-1821	91-290	622-821	603-802	916	XT0209		1.570,-

Made-to-measure - Left-hand fixing

Height	Width B1	Product no.	Base price
1900-2000	1000-1800	XT0180	1.854,-
	1801-2000	XT0181	2.248,-
2001-2200	1000-1800	XT0182	2.200,-
	1801-2000	XT0183	2.593,-

Adjustment range = dimensions - 12mm / + 0mm

Made-to-measure - Right-hand fixing

Height	Width B1	Product no.	Base price
1900-2000	1000-1800	XT0280	1.854,-
	1801-2000	XT0281	2.248,-
2001-2200	1000-1800	XT0282	2.200,-
	1801-2000	XT0283	2.593,-

Adjustment range = dimensions - 12mm / + 0mm

Dim. Range: min. - max.

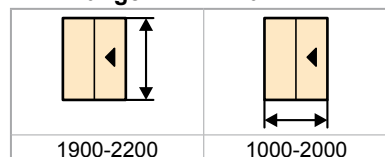

Special options

Optional variants	Product no.	Extra charges
Select+ wall profile	881	202,-
Ceiling connection 80-600mm	791	119,-
Ceiling connection 80-600mm and Select+ wall profile (colours 087 matt silver, 123 Black Edition, 069 silver high-gloss)	882	326,-

With variants 881/882 slopes and cut-outs are not possible.

Extras

Height	Profile for recess installation	Product no.	Price
2000	Profile for recess installation	XT0401	86,-
1900-2200	Profile for recess installation, made-to-measure	XT0480	111,-

Colours - Panel options

Profile colours	Colour code	Extra charges	Panel options		without Anti-Plaque		with Anti-Plaque	
			Glass code	Extra charges	Glass code	Extra charges		
Silver high-gloss	069	0,-	Clear	321	0,-	322	209,-	
Black Edition	123	171,-	Grey	301	186,-	368	395,-	
			Bronze	341		378		
			Sand Plus	315		316		
			Decor Element glass	372	299,-	389	508,-	
			Mirror glass	380	439,-	381	648,-	

HÜPPE Xtensa pure Rectangular

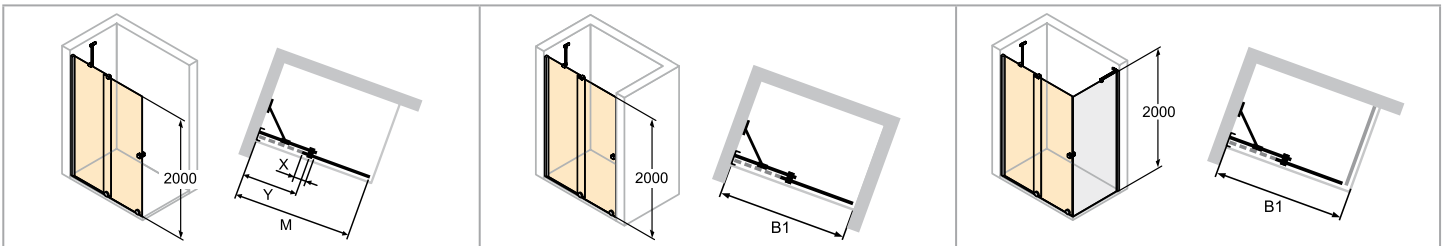

Walk-In
Left-hand fixing
Stabilizer

GTN
Stabilizer

GTS
Stabilizer

- Installation on tiled surfaces and shower trays possible. Minimum tray rim width or floor area required for installation: 50mm.
 - T-solution supplement set as an alternative to cross-bracing, see chapter Accessories and others.
 - An even/flat area of 50mm must be available.
 - Installation in U-shape possible.
 - Mirror glass (380/381): Please state in your order which segment should be produced with mirror glass. If this is not stated, the entire unit will be produced with mirror glass.
 - For technical information, see Profile Colours and Panel Options section.
- Made-to-measure: Not possible with glass 372/389 chrome decor element.**

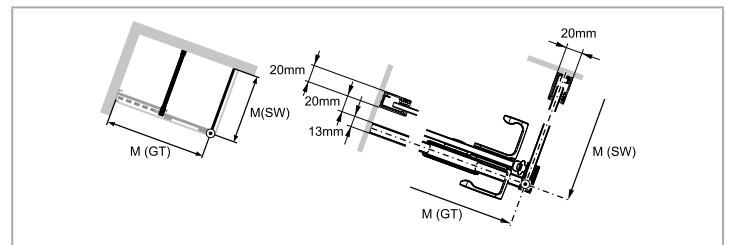
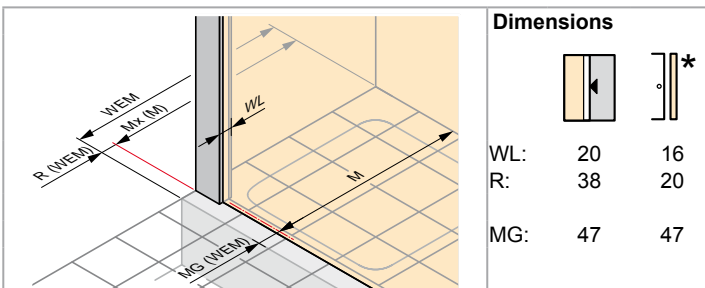

* = Profile for recess installation
 WEM = Tray installation dim. (000)
 M = Installation dimension middle of glass SW (001)
 Please always specify when ordering.

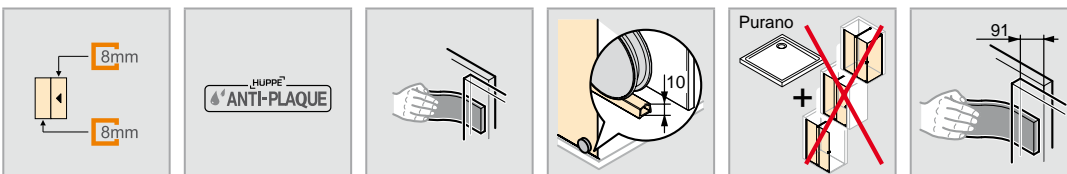

Walk-In sliding door, 1-panel with fixed segment

Left-hand fixing

Stabilizer

Height	Model	Width M = Installation dimension as Walk-In	WEM GTN	WEM GTS	M GTN	M (middle of glass SW)	Min-max overlap glass panels X	Min-max entry width recess	Min. max. entry width with side panel	Product no.	Base price	
2000	980-1000	968-1000	985-1017	1004-1036	985-1017	989-1021	91-110	402-421	383-402	XT0121	1.202,-	
	1001-1100	988-1100	1005-1117	1024-1136	1005-1117	1009-1121	91-190	372-471	353-452	XT0122		
	1101-1200	1088-1200	1105-1217	1124-1236	1105-1217	1109-1221	91-190	422-521	403-502	XT0123		1.289,-
	1201-1400	1188-1400	1205-1417	1224-1436	1205-1417	1209-1421	91-290	422-621	403-602	XT0125		1.412,-

Right-hand fixing

Stabilizer

Height	Model	Width M = Installation dimension as Walk-In	WEM GTN	WEM GTS	M GTN	M (middle of glass SW)	Min-max overlap glass panels X	Min-max entry width recess	Min. max. entry width with side panel	Product no.	Base price
2000	980-1000	968-1000	985-1017	1004-1036	985-1017	989-1021	91-110	402-421	383-402	XT0221	1.202,-
	1001-1100	988-1100	1005-1117	1024-1136	1005-1117	1009-1121	91-190	372-471	353-452	XT0222	
	1101-1200	1088-1200	1105-1217	1124-1236	1105-1217	1109-1221	91-190	422-521	403-502	XT0223	1.289,-
	1201-1400	1188-1400	1205-1417	1224-1436	1205-1417	1209-1421	91-290	422-621	403-602	XT0225	1.412,-

Made-to-measure - Left-hand fixing

Height	Width B1	Product no.	Base price
1900-2000	1000-1400	XT0184	1.956,-
2001-2200	1000-1400	XT0185	2.321,-

Adjustment range = dimensions - 12mm / + 0mm

Made-to-measure - Right-hand fixing

Height	Width B1	Product no.	Base price
1900-2000	1000-1400	XT0284	1.956,-
2001-2200	1000-1400	XT0285	2.321,-

Adjustment range = dimensions - 12mm / + 0mm

Dim. Range: min. - max.

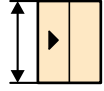
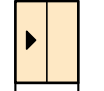
	
1900-2200	1000-1400

Special options

Optional variants		Extra charges
Select+ wall profile	881	202,-
Ceiling connection 80-600mm	791	119,-
Ceiling connection 80-600mm and Select+ wall profile (colours 087 matt silver, 123 Black Edition, 069 silver high-gloss)	882	326,-

With variants 881/882 slopes and cut-outs are not possible.

Extras

Height	Product no.	Price
2000	XT0401	86,-
1900-2200	XT0480	111,-

Colours - Panel options

Profile colours	Colour code	Extra charges	Panel options		without Anti-Plaque		with Anti-Plaque	
			Glass code	Extra charges	Glass code	Extra charges		
Silver high-gloss	069	0,-	Clear	321	0,-	322	209,-	
Black Edition	123	171,-	Grey	301		368		
			Bronze	341	186,-	378	395,-	
			Sand Plus	315		316		
			Decor Element glass	372	299,-	389	508,-	
			Mirror glass	380	439,-	381	648,-	

HÜPPE Xtensa pure Rectangular

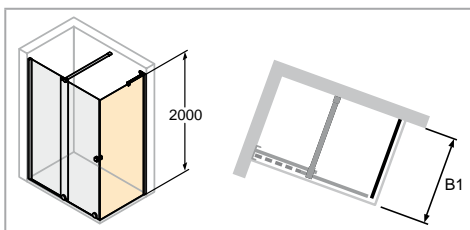

Side panel

- Towel rail height can be selected individually and must be specified with the order. If nothing is specified, the towel rail is always delivered middle of glass (height and width).

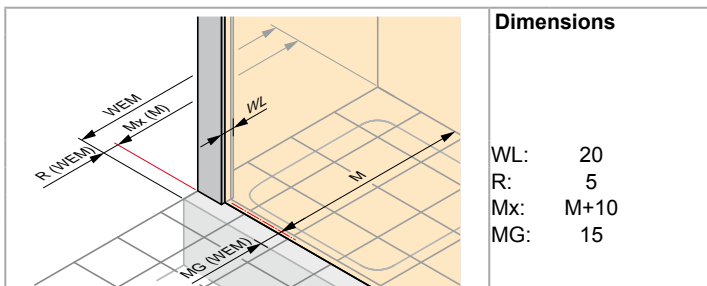

WEM = Tray installation dim. (000)
M = Installation dimension middle of floor profile GT (001)
Please always specify when ordering.

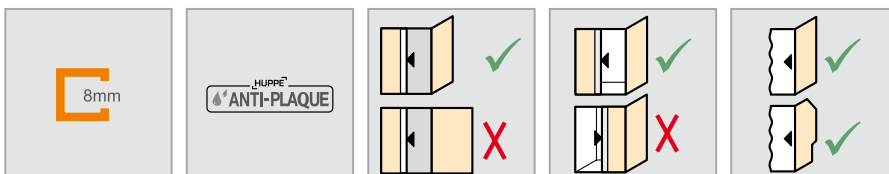

Side panel for Walk-In sliding door, 1-panel with fixed segment

Height	Model	WEM	M (middle of floor profile GT)	Product no.	Base price
2000	700	685-700	673-688	XT0305	574,-
	800	785-800	773-788	XT0306	
	900	885-900	873-888	XT0307	
	1000	985-1000	973-988	XT0308	602,-

Made-to-measure

Height	Model	Width B1	Product no.	Base price
1900-2000	Standard made-to-measure	200-1100	XT0380	736,-
2001-2200	Standard made-to-measure	200-1100	XT0382	1.083,-
400-2000	On bathtub	200-1100	XT0381	736,-

Adjustment range = dimensions - 8mm / + 7mm

! NOTE: A recess profile is required for door with side panel on bath-top. See Extras.

Slopes and cut-outs

Slopes and cut-outs	Extra charges
 Supplement per slope/cut-out for made-to-measure	170,-

Dim. Range: min. - max.

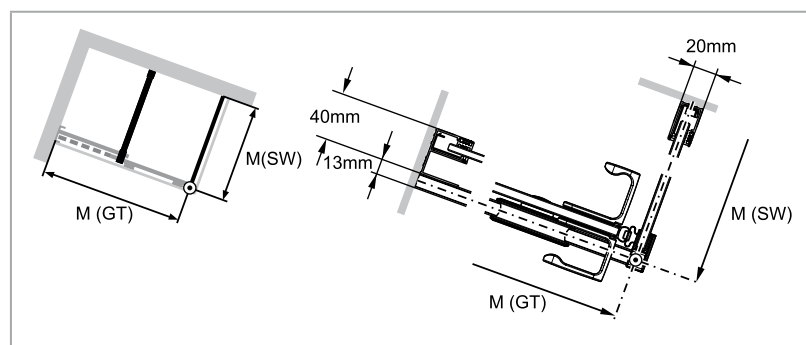
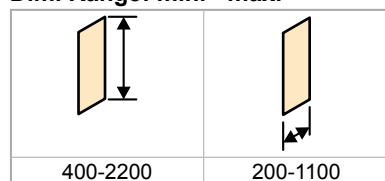

Special options

Optional variants	Product no.	Extra charges	
Towel rail (high-gloss silver as standard, towel rail in black for Black Edition systems)	T99	210,-	
Height	Product no.	Price	
2000	Profile for recess installation	XT0401	86,-
1900-2200	Profile for recess installation, made-to-measure	XT0480	111,-

Colours - Panel options

Profile colours	Colour code	Extra charges	Panel options		without Anti-Plaque		with Anti-Plaque	
			Glass code	Extra charges	Glass code	Extra charges		
Silver high-gloss	069	0,-	Clear	321	0,-	322	209,-	
Black Edition	123	171,-	Grey	301		368		
			Bronze	341	186,-	378	395,-	
			Sand Plus	315		316		
			Mirror glass	380	439,-	381	648,-	

HÜPPE Xtensa pure Rectangular

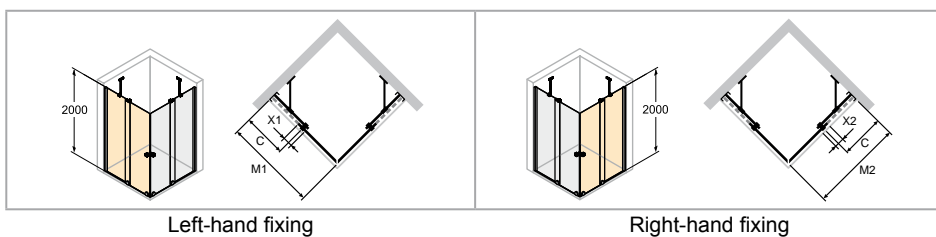
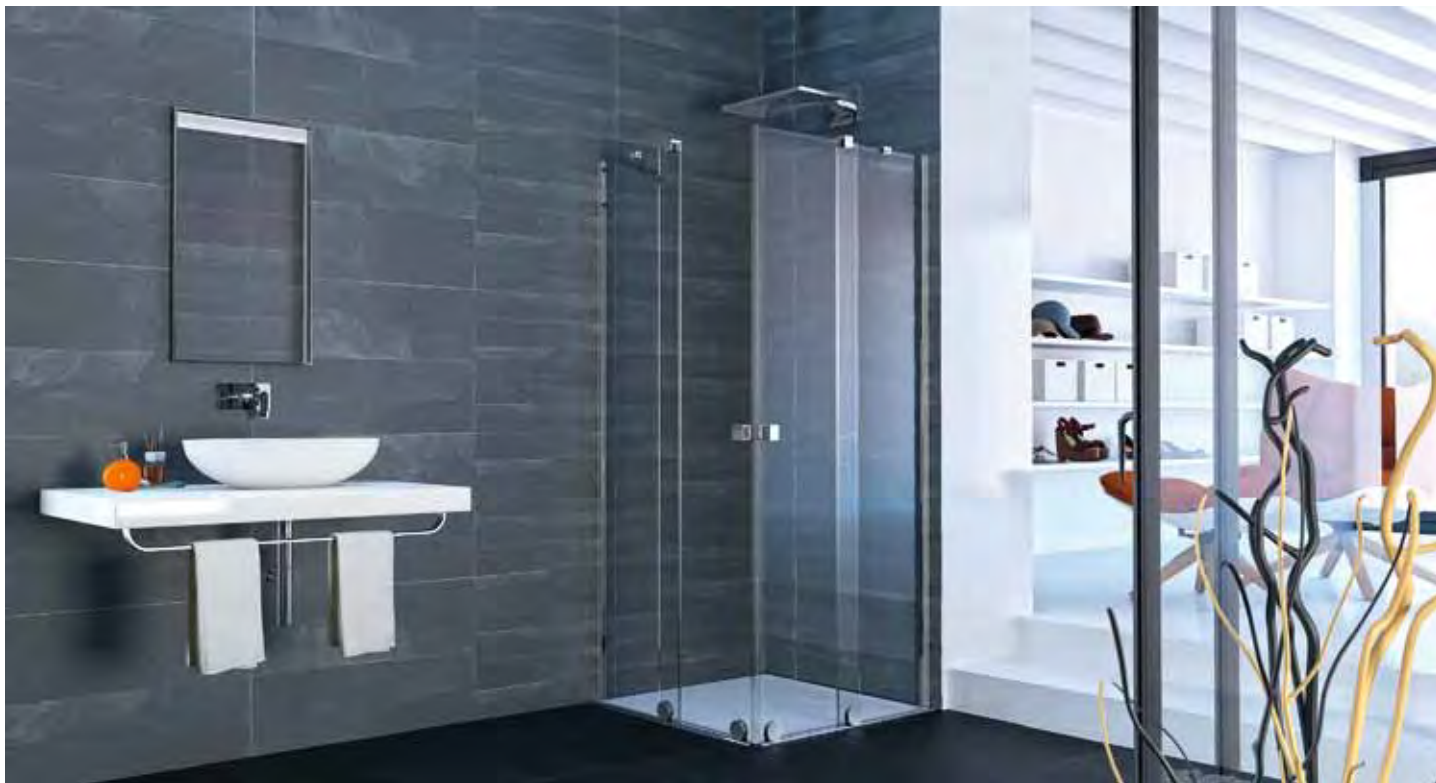

- An even/flat area of 50mm must be available.
- Installation in U-shape possible.
- Mirror glass (380/381): Please state in your order which segment should be produced with mirror glass. If this is not stated, the entire unit will be produced with mirror glass.
- For technical information, see Profile Colours and Panel Options section.

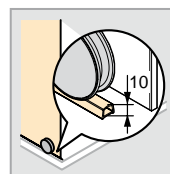
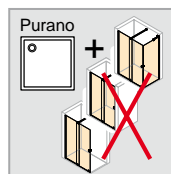
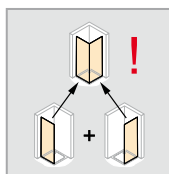
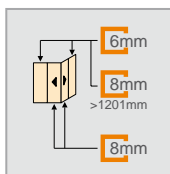
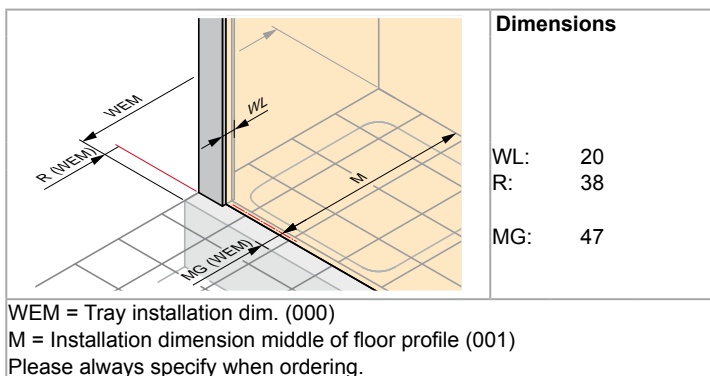

Sliding door, 2-section corner entry (1/2)

Left-hand fixing

Height	Model	WEM	M (middle of floor profile)	C	Min-max overlap glass panels X	Entry width	Product no.	Base price
2000	700-750	690-757	677-744	385-400	51-103	355-428	XT1301	905,-
	751-800	758-807	745-794	410-425	51-85	415-463	XT1302	924,-
	801-900	808-907	795-894	460-475	51-135	415-534	XT1303	952,-
	901-1000	908-1007	895-994	540-555	115-199	441-560	XT1304	1.002,-
	1001-1100	1008-1107	995-1094	590-605	115-199	511-630	XT1305	1.024,-
	1101-1200	1108-1207	1095-1194	640-655	115-199	582-701	XT1306	1.099,-
	1201-1400	1208-1407	1195-1394	740-755	115-299	582-842	XT1307	1.204,-

NOTE: The complete corner entry consists of two item nos.

Made-to-measure - Left-hand fixing

Height	Width B	Product no.	Base price
1200-2000	700-1400	XT1380	1.319,-
2001-2200	700-1400	XT1381	1.395,-

Adjustment range = dimensions - 8mm / + 7mm

Right-hand fixing

Height	Model	WEM	M (middle of floor profile)	C	Min-max overlap glass panels X	Entry width	Product no.	Base price
2000	700-750	690-757	677-744	385-400	51-103	355-428	XT1401	905,-
	751-800	758-807	745-794	410-425	51-85	415-463	XT1402	924,-
	801-900	808-907	795-894	460-475	51-135	415-534	XT1403	952,-
	901-1000	908-1007	895-994	540-555	115-199	441-560	XT1404	1.002,-
	1001-1100	1008-1107	995-1094	590-605	115-199	511-630	XT1405	1.024,-
	1101-1200	1108-1207	1095-1194	640-655	115-199	582-701	XT1406	1.099,-
	1201-1400	1208-1407	1195-1394	740-755	115-299	582-842	XT1407	1.204,-

NOTE: The complete corner entry consists of two item nos.

Made-to-measure - Right-hand fixing

Height	Width B	Product no.	Base price
1200-2000	700-1400	XT1480	1.319,-
2001-2200	700-1400	XT1481	1.395,-

Adjustment range = dimensions - 8mm / + 7mm

Dim. Range: min. - max.

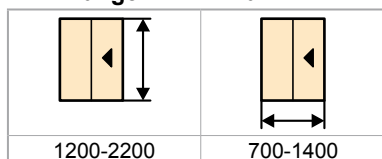

Special options

Optional variants		Extra charges
Ceiling connection 80-600mm	791	119,-

Colours - Panel options

Profile colours	Colour code	Extra charges	Panel options	without Anti-Plaque		with Anti-Plaque	
				Glass code	Extra charges	Glass code	Extra charges
Silver high-gloss	069	0,-	Clear	321	0,-	322	209,-
Black Edition	123	171,-	Grey	301		368	
			Bronze	341	186,-	378	395,-
			Sand Plus	315		316	
			Mirror glass	380	439,-	381	648,-

HÜPPE Xtensa pure Rectangular

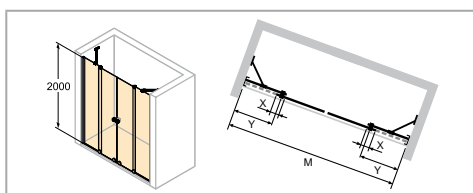

- An even/flat area of 50mm must be available.
- Installation in U-shape possible.
- Mirror glass (380/381): Please state in your order which segment should be produced with mirror glass. If this is not stated, the entire unit will be produced with mirror glass.
- For technical information, see Profile Colours and Panel Options section.

Dimensions

WL:	20
R:	38
MG:	47

WEM = Tray installation dim. (000)
M = Installation dimension middle of glass SW (001)
Please always specify when ordering.

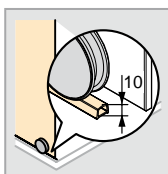
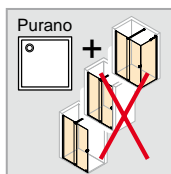
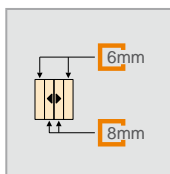

Sliding door, 2-panel with 2 fixed segments

Height	Model	WEM In recess	WEM Side panel	M (middle of glass) Recess	M (middle of glass) Side panel	C	Min-max overlap glass panels X	Min-max entry width recess	Min. max. entry width with side panel	Product no.	Base price
2000	1400-1600	1485-1615	1512-1642	1485-1615	1496-1626	460-475	131-181	538-638	511-611	XT1001	1.948,-
	1601-2000	1616-2015	1643-2042	1616-2015	1627-2026	540-555	93-277	509-878	482-851	XT1002	2.049,-
	2001-2400	2016-2415	2043-2442	2016-2415	2027-2426	640-655	93-277	709-1078	682-1051	XT1003	2.532,-
	2401-2800	2416-2815	2443-2842	2416-2815	2427-2826	740-755	93-277	909-1279	882-1251	XT1004	2.659,-

Made-to-measure

Height	Width B	Product no.	Base price
1200-2000	1400-1800	XT1080	2.460,-
	1801-2800	XT1081	3.191,-
2001-2200	1400-1800	XT1082	2.535,-
	1801-2800	XT1083	3.266,-

Adjustment range = dimensions - 15mm / + 15mm

Dim. Range: min. - max.

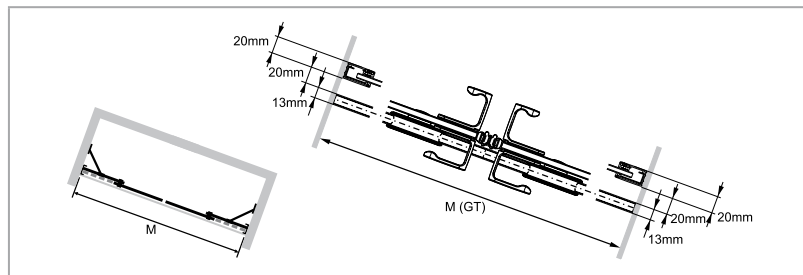
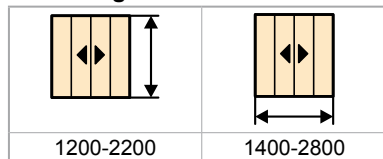

Special options

Optional variants		Extra charges
Ceiling connection 80-600mm	791	119,-

Colours - Panel options

Profile colours	Colour code	Extra charges	Panel options		without Anti-Plaque		with Anti-Plaque	
			Glass code	Extra charges	Glass code	Extra charges		
Silver high-gloss	069	0,-	Clear	321	0,-	322	418,-	
Black Edition	123	342,-	Grey	301		368		
			Bronze	341	371,-	378	789,-	
			Sand Plus	315		316		
			Mirror glass	380	439,-	381	857,-	

HÜPPE Xtensa pure Rectangular

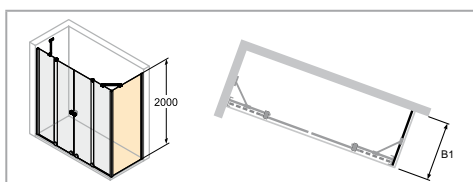

- Towel rail height can be selected individually and must be specified with the order. If nothing is specified, the towel rail is always delivered middle of glass (height and width).

Dimensions	
	WL: 20 R: 5 Mx: M+10 MG: 15
WEM = Tray installation dim. (000) M = Installation dimension middle of floor profile GT (001) Please always specify when ordering.	

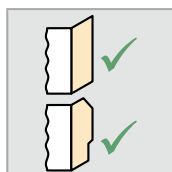
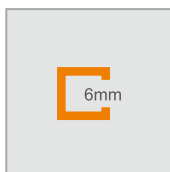

Side panel for sliding door, 2-panel with 2 fixed segments

Height	Model	WEM	M (middle of floor profile GT)	Product no.	Base price
2000	800	785-800	773-788	XT1807	574,-
	900	885-900	873-888	XT1808	
	1000	985-1000	973-988	XT1809	

Made-to-measure



Height	Model	Width B1	Product no.	Base price
1200-2000	Standard made-to-measure	200-1100	XT1880	736,-
2001-2200	Standard made-to-measure	200-1100	XT1881	1.083,-
400-1800	On bathtub	200-1100	XT1882	736,-

Adjustment range = dimensions - 15mm / + 0mm

Slopes and cut-outs

Slopes and cut-outs	Extra charges
	Supplement per slope/cut-out for made-to-measure 170,-

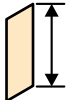
Dim. Range: min. - max.

	
400-2200	200-1100

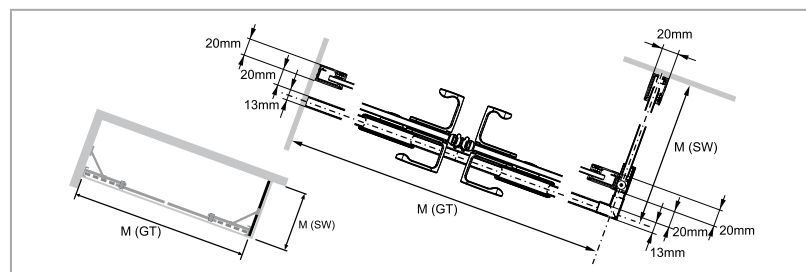

Special options

Optional variants	Extra charges
Towel rail (silver high-gloss)	T99 210,-

Colours - Panel options

Profile colours	Colour code	Extra charges	Panel options		without Anti-Plaque		with Anti-Plaque	
			Glass code	Extra charges	Glass code	Extra charges		
Silver high-gloss	069	0,-	Clear	321	0,-	322	209,-	
Black Edition	123	171,-	Grey	301		368		
			Bronze	341	186,-	378	395,-	
			Sand Plus	315		316		
			Mirror glass	380	439,-	381	648,-	

HÜPPE Xtensa pure Rectangular

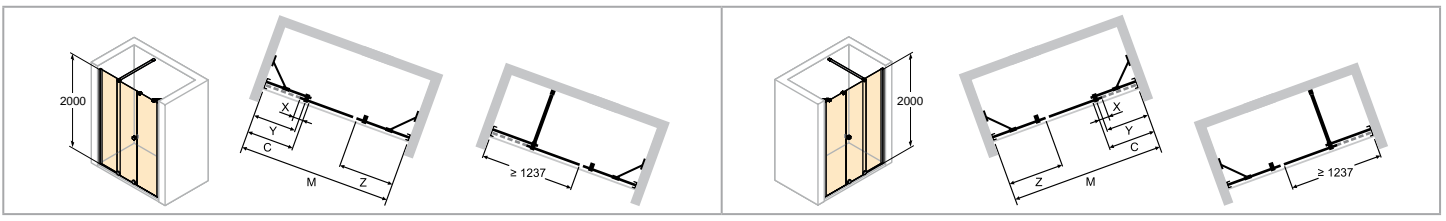

Left-hand fixing

Right-hand fixing

- An even/flat area of 50mm must be available.
- Installation in U-shape possible.
- Mirror glass (380/381): Please state in your order which segment should be produced with mirror glass. If this is not stated, the entire unit will be produced with mirror glass.
- For technical information, see Profile Colours and Panel Options section.

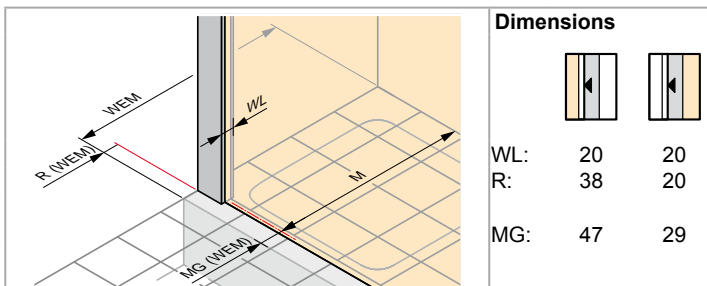

WEM = Tray installation dim. (000)
M = Installation dimension middle of glass SW (001)
Please always specify when ordering.

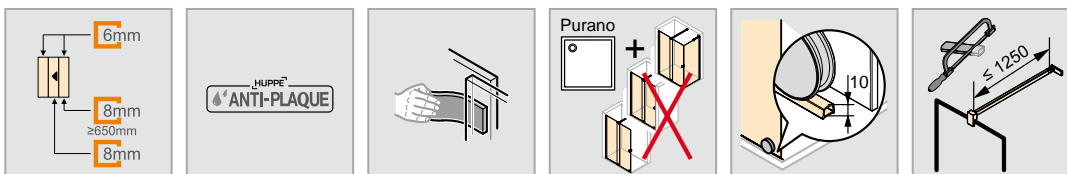
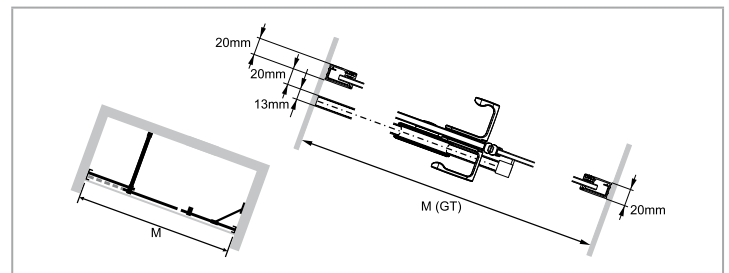

Sliding door, 1-panel with fixed segment and additional section

Left-hand fixing

Height	Model	WEM In recess	WEM with side panel	M (middle of glass) Recess	M (middle of glass) Side panel	Width C	Width Z	Entry width GTN	Entry width SW	Product no.	Base price
2000	1540-1600	1485-1615	1512-1642	1485-1615	1496-1626	640-655	385	450-540	423-513	XT1101	1.526,-
	1601-1800	1616-1815	1643-1842	1616-1815	1627-1826	740-755	385	471-640	444-613	XT1102	1.649,-
	1801-2000	1816-2015	1843-2042	1816-2015	1827-2026	840-855	385	571-740	544-713	XT1103	1.724,-
	2001-2200	2016-2215	2043-2242	2016-2215	2027-2226	840-855	590	566-735	539-708	XT1104	1.801,-
	2201-2400	2216-2415	2243-2442	2216-2415	2227-2426	940-955	590	666-835	639-808	XT1105	1.877,-
	2401-2600	2416-2615	2443-2642	2416-2615	2427-2626	1040-1055	590	766-935	739-908	XT1106	1.952,-

	Model	Min-max overlap glass panels X
	1540-1600	92-192
	1601-2000	92-261
	2001-2600	97-266

Made-to-measure - Left-hand fixing

Height	Width	Product no.	Base price
1200-2000	1400-1800	XT1180	1.832,-
	1801-2600	XT1181	2.251,-
2001-2200	1400-1800	XT1182	1.908,-
	1801-2600	XT1183	2.327,-

Adjustment range = dimensions - 15mm / + 15mm

Right-hand fixing

Height	Model	WEM In recess	WEM with side panel	M (middle of glass) Recess	M (middle of glass) Side panel	Width C	Width Z	Entry width GTN	Entry width SW	Product no.	Base price
2000	1540-1600	1485-1615	1512-1642	1485-1615	1496-1626	640-655	385	450-540	423-513	XT1201	1.526,-
	1601-1800	1616-1815	1643-1842	1616-1815	1627-1826	740-755	385	471-640	444-613	XT1202	1.649,-
	1801-2000	1816-2015	1843-2042	1816-2015	1827-2026	840-855	385	571-740	544-713	XT1203	1.724,-
	2001-2200	2016-2215	2043-2242	2016-2215	2027-2226	840-855	590	566-735	539-708	XT1204	1.801,-
	2201-2400	2216-2415	2243-2442	2216-2415	2227-2426	940-955	590	666-835	639-808	XT1205	1.877,-
	2401-2600	2416-2615	2443-2642	2416-2615	2427-2626	1040-1055	590	766-935	739-908	XT1206	1.952,-

	Model	Min-max overlap glass panels X
	1540-1600	92-192
	1601-2000	92-261
	2001-2600	97-266

Made-to-measure - Right-hand fixing

Height	Width	Product no.	Base price
1200-2000	1400-1800	XT1280	1.832,-
	1801-2600	XT1281	2.251,-
2001-2200	1400-1800	XT1282	1.908,-
	1801-2600	XT1283	2.327,-

Adjustment range = dimensions - 15mm / + 15mm

Dim. Range: min. - max.

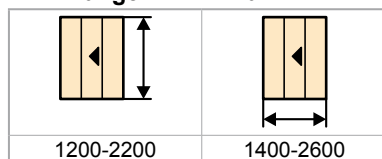

Special options

Optional variants		Extra charges
Ceiling connection 80-600mm	791	119,-

Colours - Panel options

Profile colours	Colour code	Extra charges	Panel options		without Anti-Plaque		with Anti-Plaque	
			Glass code	Extra charges	Glass code	Extra charges		
Silver high-gloss	069	0,-	Clear	321	0,-	322	418,-	
Black Edition	123	342,-	Grey	301		368		
			Bronze	341	371,-	378	789,-	
			Sand Plus	315		316		
			Mirror glass	380	439,-	381	857,-	

HÜPPE Xtensa pure Rectangular

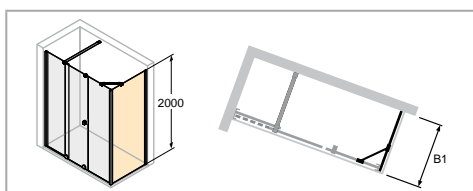

- Towel rail height can be selected individually and must be specified with the order. If nothing is specified, the towel rail is always delivered middle of glass (height and width).

	<p>Dimensions</p> <p>WL: 20 R: 5 Mx: M+10 MG: 15</p>
<p>WEM = Tray installation dim. (000) M = Installation dimension middle of floor profile GT (001) Please always specify when ordering.</p>	

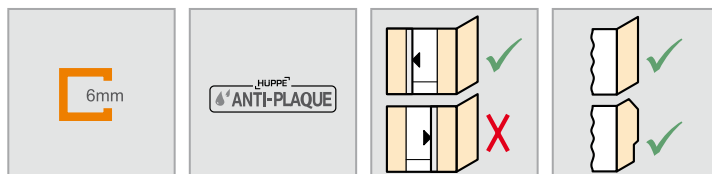

Side panel for sliding door, 1-panel with fixed segment and additional section

Height	Model	WEM	M (middle of floor profile GT)	Product no.	Base price
2000	785-800	785-800	773-788	XT1701	574,-
	885-900	885-900	873-888	XT1702	
	985-1000	985-1000	973-988	XT1703	

Made-to-measure

Height	Model	Width B1	Product no.	Base price
1200-2000	Standard made-to-measure	200-1100	XT1780	736,-
2001-2200	Standard made-to-measure	200-1100	XT1781	1.083,-
400-1800	On bathtub	200-1100	XT1782	736,-

Adjustment range = dimensions - 15mm / + 0mm

Slopes and cut-outs

Slopes and cut-outs	Extra charges
 Supplement per slope/cut-out for made-to-measure	170,-

Dim. Range: min. - max.

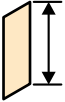
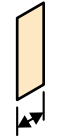
	
400-2200	200-1100

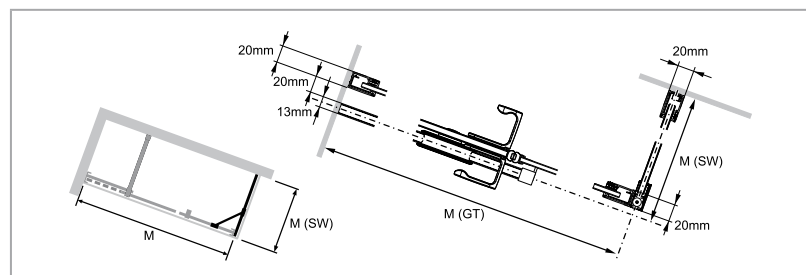

Special options

Optional variants	Extra charges
Towel rail (silver high-gloss)	T99 210,-

Colours - Panel options

Profile colours	Colour code	Extra charges	Panel options		without Anti-Plaque		with Anti-Plaque	
			Glass code	Extra charges	Glass code	Extra charges		
Silver high-gloss	069	0,-	Clear	321	0,-	322	209,-	
Black Edition	123	171,-	Grey	301		368		
			Bronze	341	186,-	378	395,-	
			Sand Plus	315		316		
			Mirror glass	380	439,-	381	648,-	

HÜPPE Refresh pure



Rectangular

Swing door corner entry

Swing door corner entry with fixed segments

Swing door for side panel

Swing door in recess

Swing door with fixed segment for side panel

Swing door with fixed segment in recess

Side panel for swing door

Two-way door in recess

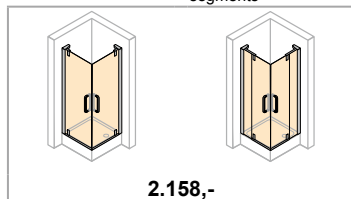

2.158,-

N.4-N.5

N.4-N.5

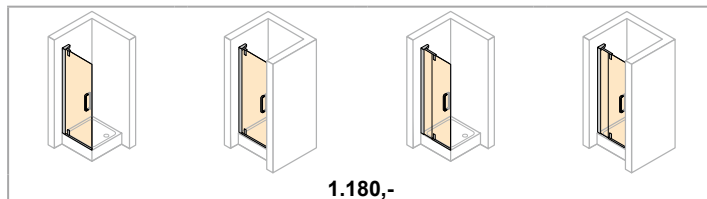

1.180,-

N.6-N.7

N.6-N.7

N.8-N.9

N.8-N.9

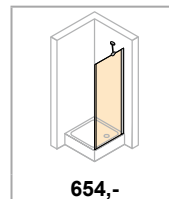

654,-

N.10-N.11

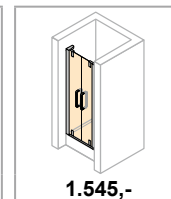

1.545,-

N.12-N.13

Quadrant

Swing door with fixed segments, 2-panel

Swing door with fixed segments, 1-panel

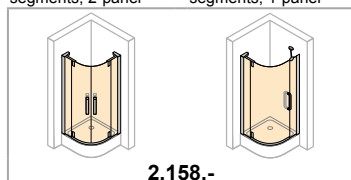

2.158,-

N.14-N.15

N.16-N.17

Pentagonal

Swing door with fixed segments, 2-panel

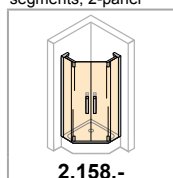

2.158,-

N.18-N.19

Semicircular

Swing door with fixed panels

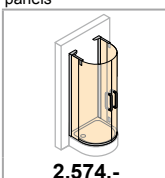

2.574,-

N.20-N.21

HÜPPE Refresh pure



Product details



Doors open inwards and outwards thanks to unique hinge technology. The high-gloss silver highlights offer a two-toned look.



Flush fitting internal hinges offer a refined look and easy cleaning benefits

Wall bracket, fixed panel holder, stabilizer, handle, hinges and cover caps always in high-gloss silver.



The wall profile has an integral adjustment profile and sealing technology and therefore there are no visible screws.



The timeless handle design accentuates the pleasant feel

HÜPPE Refresh pure Rectangular

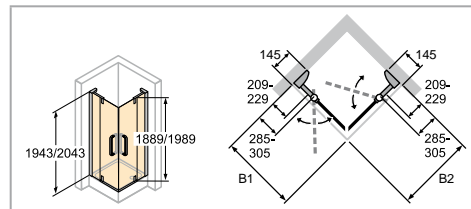
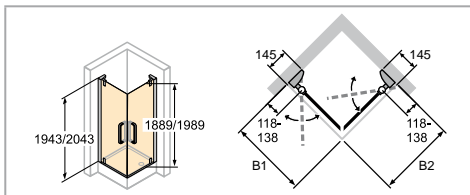

	Dimensions
	<p>WL: 33 R: 19 Mx: M+11 MG: 30</p>
<p>WEM = Tray installation dim. (000) M = installation dimension Centre glass (001) Please always specify when ordering.</p>	

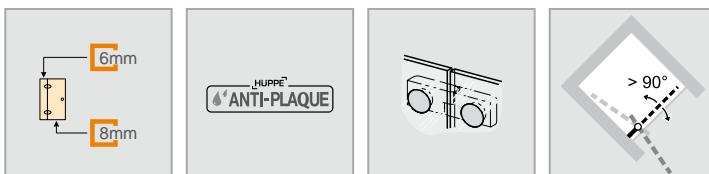

Swing door corner entry

Height	Model B1/B2	WEM B1	WEM B2	M (middle of glass) B1	M (middle of glass) B2	Entry width	Product no.	Base price		
1943	800x800	785-805	785-805	755-775	755-775	892	9P0101	2.158,-		
	900x900	885-905	885-905	855-875	855-875	1034	9P0102			
	1000x1000	985-1005	985-1005	955-975	955-975	1175	9P0103		2.246,-	
	2043	750x900	735-755	885-905	705-725	855-875	925	9P0104	2.158,-	
		900x750	885-905	735-755	855-875	705-725	925	9P0105		
		800x900	785-805	885-905	755-775	855-875	965	9P0106		
		2043	900x800	885-905	785-805	855-875	755-775	965	9P0107	2.246,-
			800x1000	785-805	985-1005	755-775	955-975	1042	9P0108	
			1000x800	985-1005	785-805	955-975	755-775	1042	9P0109	
2043			800x800	785-805	785-805	755-775	755-775	892	9P0110	2.373,-
			900x900	885-905	885-905	855-875	855-875	1034	9P0111	
			1000x1000	985-1005	985-1005	955-975	955-975	1175	9P0112	
	2043		750x900	735-755	885-905	705-725	855-875	925	9P0113	2.373,-
			900x750	885-905	735-755	855-875	705-725	925	9P0114	
			800x900	785-805	885-905	755-775	855-875	965	9P0115	
		2043	900x800	885-905	785-805	855-875	755-775	965	9P0116	2.469,-
			800x1000	785-805	985-1005	755-775	955-975	1042	9P0117	
			1000x800	985-1005	785-805	955-975	755-775	1042	9P0118	

Made-to-measure

Height	Width B1	Width B2	Product no.	Base price
1443-2043	400-1000	400-1000	9P0180	2.805,-

Adjustment range = dimensions - 10mm / + 10mm

Prices are per corner entry.

Swing door corner entry with fixed segments

Height	Model B1/B2	WEM B1	WEM B2	M (middle of glass) B1	M (middle of glass) B2	Entry width	Product no.	Base price			
1943	800x800	785-805	785-805	755-775	755-775	657	9P0201	2.158,-			
	900x900	885-905	885-905	855-875	855-875	798	9P0202				
	1000x1000	985-1005	985-1005	955-975	955-975	939	9P0203		2.246,-		
	1943	1200x1200	1185-1205	1185-1205	1155-1175	1155-1175	1222	9P0204	2.288,-		
		750x900	735-755	885-905	705-725	855-875	700	9P0205	2.158,-		
		900x750	885-905	735-755	855-875	705-725	700	9P0206			
		800x900	785-805	885-905	755-775	855-875	731	9P0207			
		2043	900x800	885-905	785-805	855-875	755-775	731	9P0208	2.246,-	
			800x1000	785-805	985-1005	755-775	955-975	810	9P0209		
			1000x800	985-1005	785-805	955-975	755-775	810	9P0210		
			2043	800x1200	785-805	1185-1205	755-775	1155-1175	981	9P0211	2.288,-
				1200x800	1185-1205	785-805	1155-1175	755-775	981	9P0212	
800x800	785-805			785-805	755-775	755-775	657	9P0213	2.373,-		
2043	900x900			885-905	885-905	855-875	855-875	798		9P0214	
	1000x1000			985-1005	985-1005	955-975	955-975	939		9P0215	2.469,-
	1200x1200			1185-1205	1185-1205	1155-1175	1155-1175	1222	9P0216	2.516,-	
	750x900	735-755		885-905	705-725	855-875	700	9P0217	2.373,-		
	900x750	885-905		735-755	855-875	705-725	700	9P0218			
	800x900	785-805		885-905	755-775	855-875	731	9P0219			
	2043	900x800		885-905	785-805	855-875	755-775	731	9P0220	2.469,-	
		800x1000		785-805	985-1005	755-775	955-975	810	9P0221		
		1000x800		985-1005	785-805	955-975	755-775	810	9P0222		
2043		800x1200	785-805	1185-1205	755-775	1155-1175	981	9P0223	2.516,-		
		1200x800	1185-1205	785-805	1155-1175	755-775	981	9P0224			

Made-to-measure

Height	Width B1	Width B2	Product no.	Base price
1443-2043	700-1200	700-1200	9P0280	2.805,-

Adjustment range = dimensions - 10mm / + 10mm

Prices are per corner entry.

Colours - Panel options

Profile colours	Colour code	Extra charges	Panel options		without Anti-Plaque		with Anti-Plaque	
			Glass code	Extra charges	Glass code	Extra charges		
White	055	0,-	Clear	321	0,-	322	418,-	
Titanium silver	084		Karo	311	371,-	312	789,-	
Matt silver	087		Sand Plus	315		316		
Silver high-gloss	092		312,-					

HÜPPE Refresh pure Rectangular

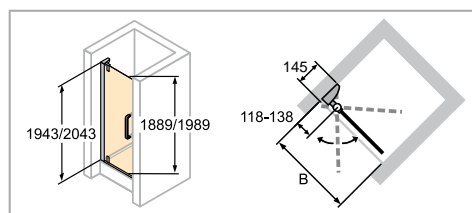
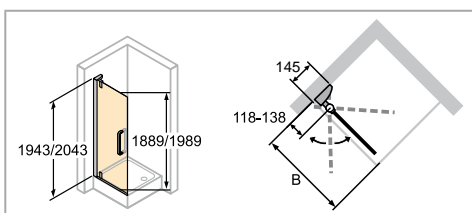

• For side panel with bathtub (SWK) the door in recess must be used.

Swing door for side panel:

• With the side panel inline the door for side panel must be used.

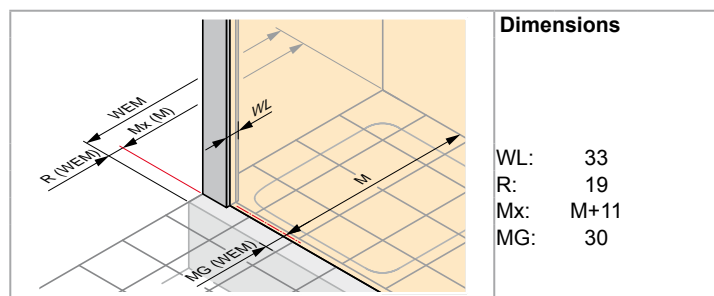

WEM = Tray installation dim. (000)

M = installation dimension Centre glass (001)

Please always specify when ordering.

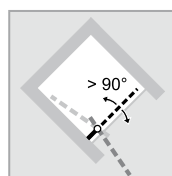
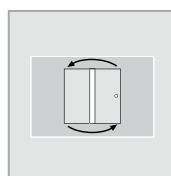
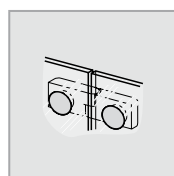
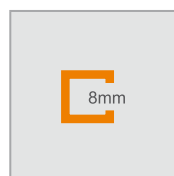

Swing door for side panel

Height	Model	WEM B	M (middle of glass) B	Entry width	Product no.	Base price
1943	800	785-805	755-775	620	9P0301	1.180,-
	900	885-905	855-875	720	9P0302	
	1000	985-1005	955-975	820	9P0303	
2043	800	785-805	755-775	620	9P0304	1.300,-
	900	885-905	855-875	720	9P0305	
	1000	985-1005	955-975	820	9P0306	

Made-to-measure

Height	Width B	Product no.	Base price
1443-2043	650-1000	9P0380	1.535,-

Adjustment range = dimensions - 10mm / + 10mm

Dim. Range: min. - max.

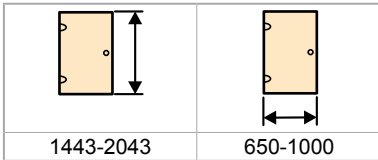

Swing door in recess

Height	Model	WEM B	M (middle of glass) B	Entry width	Product no.	Base price
1943	800	765-805	765-805	605	9P0401	1.180,-
	900	865-905	865-905	705	9P0402	
	1000	965-1005	965-1005	805	9P0403	
2043	800	765-805	765-805	605	9P0404	1.300,-
	900	865-905	865-905	705	9P0405	
	1000	965-1005	965-1005	805	9P0406	

Made-to-measure

Height	Width B	Product no.	Base price
1443-2043	650-1000	9P0480	1.535,-

Adjustment range = dimensions - 20mm / + 20mm

Dim. Range: min. - max.

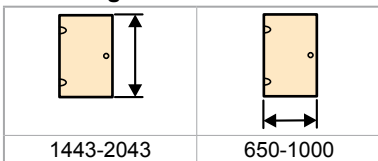

Colours - Panel options

Profile colours	Colour code	Extra charges	Panel options		without Anti-Plaque		with Anti-Plaque	
			Glass code	Extra charges	Glass code	Extra charges		
White	055	0,-	Clear	321	0,-	322	209,-	
Titanium silver	084		Karo	311	186,-	312	395,-	
Matt silver	087		Sand Plus	315		316		
Silver high-gloss	092		156,-					

HÜPPE Refresh pure Rectangular

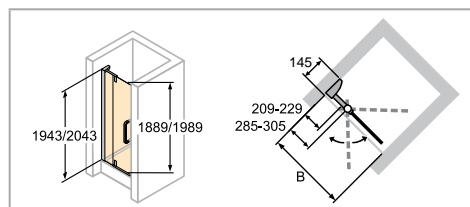
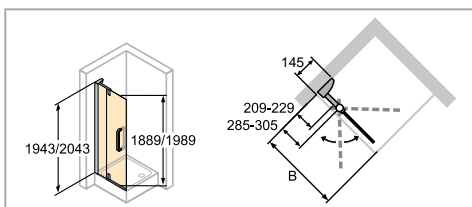

- For side panel with bathtub (SWK) the door in recess must be used.
- Swing door with fixed segment for side panel:**
- With the side panel inline the door for side panel must be used.

Dimensions	
WL:	33
R:	19
Mx:	M+11
MG:	30

WEM = Tray installation dim. (000)
M = installation dimension Centre glass (001)
Please always specify when ordering.

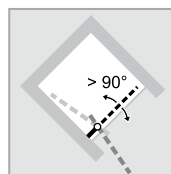
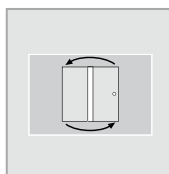
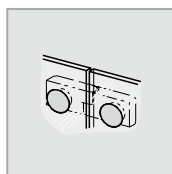
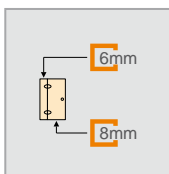

Swing door with fixed segment for side panel



Height	Model	WEM B	M (middle of glass) B	Entry width	Product no.	Base price
1943	800	785-805	755-775	450	9P0501	1.180,-
	900	885-905	855-875	550	9P0502	
	1000	985-1005	955-975	650	9P0503	1.230,-
	1200	1185-1205	1155-1175	850	9P0504	1.249,-
2043	800	785-805	755-775	450	9P0505	1.300,-
	900	885-905	855-875	550	9P0506	
	1000	985-1005	955-975	650	9P0507	1.351,-
	1200	1185-1205	1155-1175	850	9P0508	1.378,-

Made-to-measure

Height	Width B	Product no.	Base price
1443-2043	800-1200	9P0580	1.535,-

Adjustment range = dimensions - 10mm / + 10mm

Dim. Range: min. - max.

	
1443-2043	800-1200

Swing door with fixed segment in recess



Height	Model	WEM B	M (middle of glass) B	Entry width	Product no.	Base price
1943	800	765-805	765-805	435	9P0601	1.180,-
	900	865-905	865-905	535	9P0602	
	1000	965-1005	965-1005	635	9P0603	1.230,-
	1200	1165-1205	1165-1205	835	9P0604	1.249,-
2043	800	765-805	765-805	435	9P0605	1.300,-
	900	865-905	865-905	535	9P0606	
	1000	965-1005	965-1005	635	9P0607	1.351,-
	1200	1165-1205	1165-1205	835	9P0608	1.378,-

Made-to-measure

Height	Width B	Product no.	Base price
1443-2043	800-1200	9P0680	1.535,-

Adjustment range = dimensions - 20mm / + 20mm

Dim. Range: min. - max.

	
1443-2043	800-1200

Colours - Panel options

Profile colours	Colour code	Extra charges	Panel options	without Anti-Plaque		with Anti-Plaque	
				Glass code	Extra charges	Glass code	Extra charges
White	055	0,-	Clear	321	0,-	322	209,-
Titanium silver	084		Karo	311	186,-	312	395,-
Matt silver	087		Sand Plus	315		316	
Silver high-gloss	092		156,-				

HÜPPE Refresh pure Rectangular

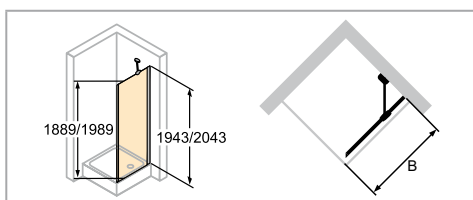

- With the side panel in line the door for side panel must be used.
- For side panel with bathtub (SWK) the door in recess must be used.
- Towel rail height can be selected individually and must be specified with the order. If nothing is specified, the towel rail is always delivered middle of glass (height and width).

Dimensions	
WL:	33
R:	19
Mx:	M+11
MG:	30

WEM = Tray installation dim. (000)
M = installation dimension Centre glass (001)
Please always specify when ordering.

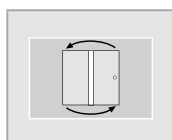
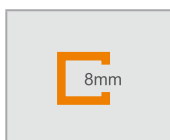

Side panel for swing door

Height	Model	WEM B	M (middle of glass) B	Product no.	Base price
1943	SW 700	685-705	655-675	9P0701	654,-
	SW 750	735-755	705-725	9P0702	
	SW 800	785-805	755-775	9P0703	
	SW 900	885-905	855-875	9P0704	682,-
	SW 1000	985-1005	955-975	9P0705	
	SW 1200	1185-1205	1155-1175	9P0706	
1693	SWK 750	735-755	705-725	9P0707	654,-
	SWK 800	785-805	755-775	9P0708	
	SWK 900	885-905	855-875	9P0709	
2043	SW 700	685-705	655-675	9P0710	722,-
	SW 750	735-755	705-725	9P0711	
	SW 800	785-805	755-775	9P0712	
	SW 900	885-905	855-875	9P0713	750,-
	SW 1000	985-1005	955-975	9P0714	
	SW 1200	1185-1205	1155-1175	9P0715	
1793	SWK 750	735-755	705-725	9P0716	654,-
	SWK 800	785-805	755-775	9P0717	
	SWK 900	885-905	855-875	9P0718	

Made-to-measure

Height	Model	Width B	Product no.	Base price
to 2043	Corner configuration	200-1200	9P0780	852,-
	In-line configuration	200-1200	9P0781	
	On bathtub (only with door in recess)	200-1200	9P0782	

Adjustment range = dimensions - 10mm / + 10mm

Slopes and cut-outs

Slopes and cut-outs	Extra charges
 Supplement per slope/cut-out for made-to-measure	170,-

Dim. Range: min. - max.

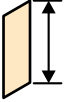
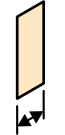
	
1443-2043	200-1200

Special options

Special options	Product no.	Extra charges
Towel rail (silver high-gloss)	T99	210,-

Colours - Panel options

Profile colours	Colour code	Extra charges	Panel options	without Anti-Plaque		with Anti-Plaque	
				Glass code	Extra charges	Glass code	Extra charges
White	055	0,-	Clear	321	0,-	322	209,-
Titanium silver	084		Karo	311	186,-	312	395,-
Matt silver	087		Sand Plus	315		316	
Silver high-gloss	092		114,-				

HÜPPE Refresh pure Rectangular

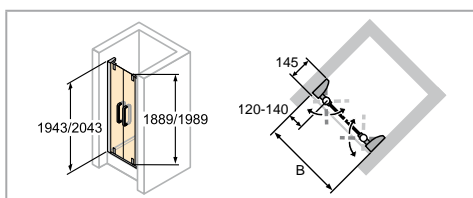

	<p>Dimensions</p> <p>WL: 33 R: 19 Mx: M+11 MG: 30</p>
<p>WEM = Tray installation dim. (000) M = installation dimension Centre glass (001) Please always specify when ordering.</p>	

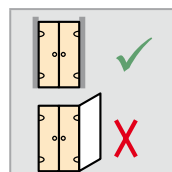
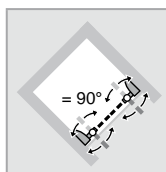
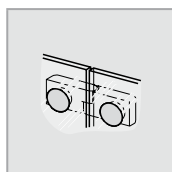
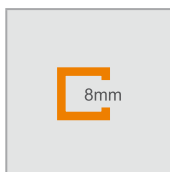

Two-way door in recess

Height	Model	WEM B	M (middle of glass) B	Entry width	Product no.	Base price
1943	700	665-705	665-705	422	9P0901	1.545,-
	800	765-805	765-805	522	9P0902	
	900	865-905	865-905	622	9P0903	
	1000	965-1005	965-1005	722	9P0904	
2043	700	665-705	665-705	422	9P0905	1.699,-
	800	765-805	765-805	522	9P0906	
	900	865-905	865-905	622	9P0907	
	1000	965-1005	965-1005	722	9P0908	

Made-to-measure

Height	Width B	Product no.	Base price
1215-2043	680-1800	9P0980	2.008,-

Adjustment range = dimensions - 25mm / + 15mm

Dim. Range: min. - max.

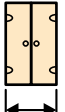
	
1215-2043	680-1800

Colours - Panel options

Profile colours	Colour code	Extra charges	Panel options	without Anti-Plaque		with Anti-Plaque	
				Glass code	Extra charges	Glass code	Extra charges
White	055	0,-	Clear	321	0,-	322	209,-
Titanium silver	084		Karo	311	186,-	312	395,-
Matt silver	087		Sand Plus	315		316	
Silver high-gloss	092		156,-				

HÜPPE Refresh pure Quadrant

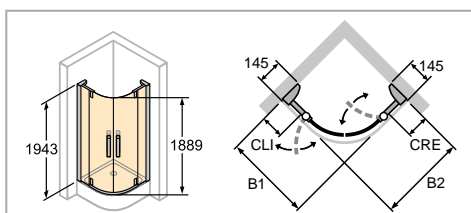

Dimensions	
WL:	33
R:	19
Mx:	M+11
MG:	30

WEM = Tray installation dim. (000)
M = installation dimension Centre glass (001)
Please always specify when ordering.



Swing door with fixed segments, 2-panel



Height	Model B1/B2	WEM B1	WEM B2	M (middle of glass) B1	M (middle of glass) B2	CLI	CRE	Entry width	Radius	Product no.	Base price
1943	800 x 800	785-805	785-805	755-775	755-775	160-180	160-180	734	500	9P1201	2.158,-
	900 x 900	885-905	885-905	855-875	855-875	260-280	260-280	734	500	9P1202	
	1000 x 1000	985-1005	985-1005	955-975	955-975	360-380	360-380	734	500	9P1203	
	800 x 900	785-805	885-905	755-775	855-875	160-180	260-280	734	500	9P1204	2.158,-
	900 x 800	885-905	785-805	855-875	755-775	260-280	160-180	734	500	9P1205	
	800 x 1000	785-805	985-1005	755-775	955-975	160-180	360-380	734	500	9P1206	
	1000 x 800	985-1005	785-805	955-975	755-775	360-380	160-180	734	500	9P1207	2.246,-
	900 x 1000	885-905	985-1005	855-875	955-975	260-280	360-380	734	500	9P1208	
	1000 x 900	985-1005	885-905	955-975	855-875	360-380	260-280	734	500	9P1209	
	900 x 1200	885-905	1185-1205	855-875	1155-1175	260-280	560-580	734	500	9P1210	2.288,-
	1200 x 900	1185-1205	885-905	1155-1175	855-875	560-580	260-280	734	500	9P1211	
	900 x 900	885-905	885-905	855-875	855-875	207-227	207-227	798	550	9P1212	
1000 x 1000	985-1005	985-1005	955-975	955-975	307-327	307-327	798	550	9P1213	2.246,-	

Made-to-measure

Height	Width B1	Width B2	CLI/CRE	Radius	Product no.	Base price
1943	800-1200	800-1200	160-580	500	9P1280	2.805,-
	800-1200	800-1200	160-580	550	9P1281	

Adjustment range = dimensions - 10mm / + 10mm

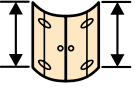
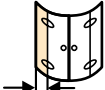
Dim. Range: min. - max.

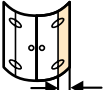
				
1943	160-580	800-1200	800-1200	160-580

Colours - Panel options

Profile colours	Colour code	Extra charges	Panel options		without Anti-Plaque		with Anti-Plaque	
			Glass code	Extra charges	Glass code	Extra charges		
White	055	0,-	Clear	321	0,-	322	418,-	
Titanium silver	084		Karo	311	371,-	312	789,-	
Matt silver	087		Sand Plus	315		316		
Silver high-gloss	092		312,-					

HÜPPE Refresh pure Quadrant

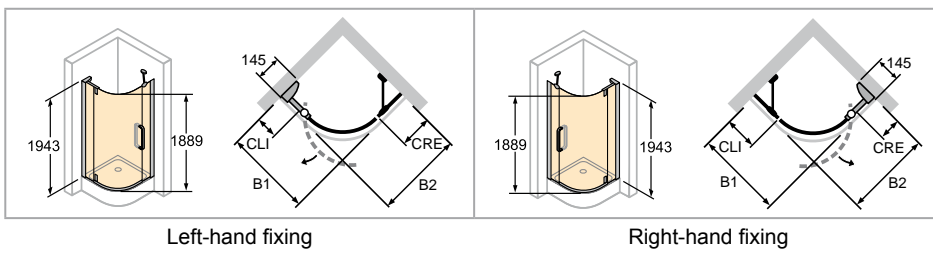

- Tray installation dimension > 900mm; the wall profile on the door side has to be installed with a tilt of 5mm towards the outside.

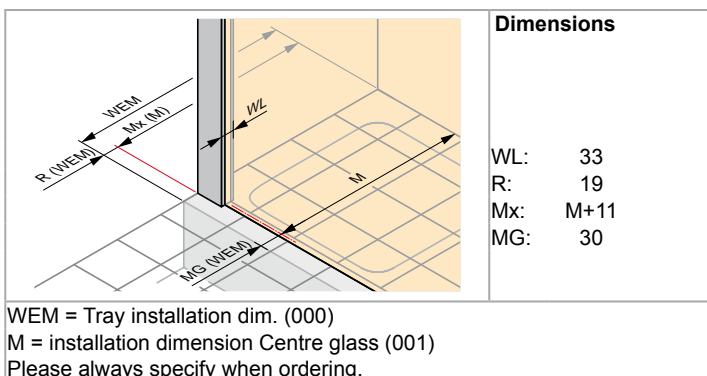

Swing door with fixed segments, 1-panel

Left-hand fixing

Height	Model B1/B2	WEM B1	WEM B2	M (middle of glass) B1	M (middle of glass) B2	CLI	CRE	Entry width	Radius	Product no.	Base price
1943	900 x 900	885-905	885-905	855-875	855-875	260-280	363-383	715	500	9P1101	2.158,-
	1000 x 1000	985-1005	985-1005	955-975	955-975	360-380	463-483	715	500	9P1102	2.246,-
	800 x 900	785-805	885-905	755-775	855-875	160-180	363-383	715	500	9P1103	2.158,-
	900 x 800	885-905	785-805	855-875	755-775	260-280	263-283	715	500	9P1104	
	800 x 1000	785-805	985-1005	755-775	955-975	160-180	463-483	715	500	9P1105	2.246,-
	1000 x 800	985-1005	785-805	955-975	755-775	360-380	263-283	715	500	9P1106	
	900 x 1000	885-905	985-1005	855-875	955-975	260-280	463-483	715	500	9P1107	
	1000 x 900	985-1005	885-905	955-975	855-875	360-380	363-383	715	500	9P1108	
	900 x 1200	885-905	1185-1205	855-875	1155-1175	260-280	663-683	715	500	9P1109	2.288,-
	1200 x 900	1185-1205	885-905	1155-1175	855-875	560-580	363-383	715	500	9P1110	
	900 x 900	885-905	885-905	855-875	855-875	214-234	317-337	780	550	9P1111	2.158,-
1000 x 1000	985-1005	985-1005	955-975	955-975	314-334	417-437	780	550	9P1112	2.246,-	

Made-to-measure - Left-hand fixing

Height	Width B1	Width B2	CLI	CRE	Radius	Product no.	Base price
1943	800-1200	800-1200	160-580	263-683	500	9P1180	2.805,-
	800-1200	800-1200	160-580	263-683	550	9P1181	

Adjustment range = dimensions - 10mm / + 10mm

Right-hand fixing

Height	Model B1/B2	WEM B1	WEM B2	M (middle of glass) B1	M (middle of glass) B2	CLI	CRE	Entry width	Radius	Product no.	Base price
1943	900 x 900	885-905	885-905	855-875	855-875	363-383	260-280	715	500	9P1501	2.158,-
	1000 x 1000	985-1005	985-1005	955-975	955-975	463-483	360-380	715	500	9P1502	2.246,-
	800 x 900	785-805	885-905	755-775	855-875	263-283	260-280	715	500	9P1503	2.158,-
	900 x 800	885-905	785-805	855-875	755-775	363-383	160-180	715	500	9P1504	
	800 x 1000	785-805	985-1005	755-775	955-975	263-283	360-380	715	500	9P1505	2.246,-
	1000 x 800	985-1005	785-805	955-975	755-775	463-483	160-180	715	500	9P1506	
	900 x 1000	885-905	985-1005	855-875	955-975	363-383	360-380	715	500	9P1507	
	1000 x 900	985-1005	885-905	955-975	855-875	463-483	260-280	715	500	9P1508	
	900 x 1200	885-905	1185-1205	855-875	1155-1175	363-383	560-580	715	500	9P1509	2.288,-
	1200 x 900	1185-1205	885-905	1155-1175	855-875	663-683	260-280	715	500	9P1510	
	900 x 900	885-905	885-905	855-875	855-875	317-337	214-234	780	550	9P1511	2.158,-
1000 x 1000	985-1005	985-1005	955-975	955-975	417-437	314-334	780	550	9P1512	2.246,-	

Made-to-measure - Right-hand fixing

Height	Width B1	Width B2	CLI	CRE	Radius	Product no.	Base price
1943	800-1200	800-1200	263-683	160-580	500	9P1580	2.805,-
	800-1200	800-1200	263-683	160-580	550	9P1581	

Adjustment range = dimensions - 10mm / + 10mm

Dim. Range: min. - max.

1943	160-580	800-1200	800-1200	263-683

Colours - Panel options

Profile colours	Colour code	Extra charges	Panel options		without Anti-Plaque		with Anti-Plaque	
			Glass code	Extra charges	Glass code	Extra charges		
White	055		Clear	321	0,-	322	418,-	
Titanium silver	084	0,-	Karo	311	371,-	312	789,-	
Matt silver	087		Sand Plus	315		316		
Silver high-gloss	092	312,-						

HÜPPE Refresh pure Pentagonal

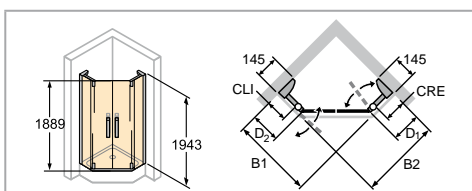

	<p>Dimensions</p> <p>WL: 33 R: 19 Mx: M+11 MG: 30</p>
<p>WEM = Tray installation dim. (000) M = installation dimension Centre glass (001) Please always specify when ordering.</p>	



Swing door with fixed segments, 2-panel

Height	Model B1/B2	WEM B1/B2	M (middle of glass) B1/B2	CLI	CRE	D2/D1 left/right	Entry width	Product no.	Base price
1943	900 x 900	885-905/885-905	855-875/855-875	260-280	260-280	336-356/336-356	655	9P1301	2.158,-
	1000 x 1000	985-1005/985-1005	955-975/955-975	308-328	308-328	384-404/384-404	725	9P1302	2.246,-

Colours - Panel options

Profile colours	Colour code	Extra charges	Panel options	without Anti-Plaque		with Anti-Plaque	
				Glass code	Extra charges	Glass code	Extra charges
White	055	0,-	Clear	321	0,-	322	418,-
Titanium silver	084		Karo	311	371,-	312	789,-
Matt silver	087		Sand Plus	315		316	
Silver high-gloss	092		312,-				

HÜPPE Refresh pure Semicircular

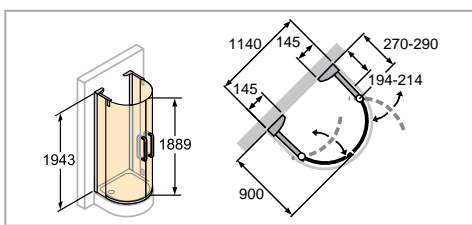

- Wall profiles are installed with a tilt of 7mm towards the outside.

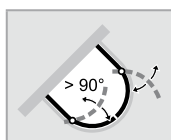
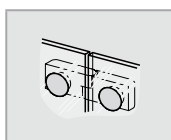
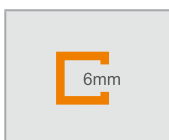
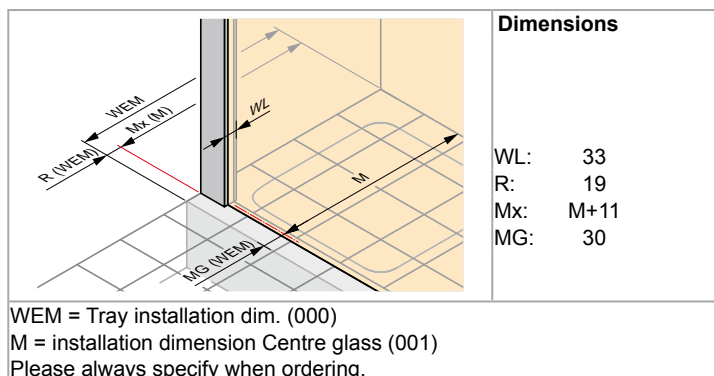

Swing door with fixed panels

Height	Model	WEM	Entry width	Radius	Product no.	Base price
1943	1140 x 900	885-905	1076	570	9P1401	2.574,-

Colours - Panel options

Profile colours	Colour code	Extra charges	Panel options	without Anti-Plaque		with Anti-Plaque	
				Glass code	Extra charges	Glass code	Extra charges
White	055	0,-	Clear	321	0,-	322	418,-
Titanium silver	084		Karo	311	371,-	312	789,-
Matt silver	087		Sand Plus	315		316	
Silver high-gloss	092		312,-				

HÜPPE Vista pure frameless



HÜPPE Vista pure frameless model overview - Base price

Rectangular

Sliding door, 1-panel with fixed segment in recess

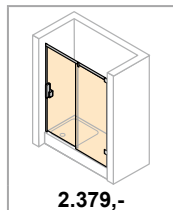

2.379,-

O.4-O.5

Sliding door, 2-panel with fixed segments in recess

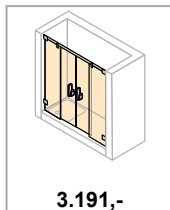

3.191,-

O.6-O.7

Sliding door, 1-panel with fixed segment and side panel

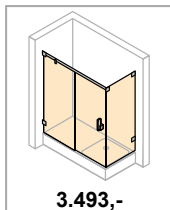

3.493,-

O.8-O.9

Sliding door, 2-panel with fixed segments and side panel

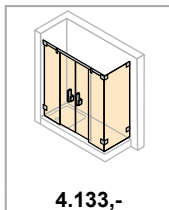

4.133,-

O.10-O.11

Sliding door corner entry

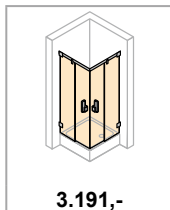

3.191,-

O.12-O.13

Sliding door, 2-panel with fixed segments and two side panels as U-shaped enclosure

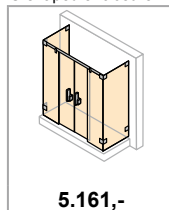

5.161,-

O.14-O.15

HÜPPE Vista pure frameless



Product details



Frameless wall attachment in unique angular design



Modern handle design



Innovative roller guide



Can be installed with or without drip deflector strip



Easy release mechanism at the base of the door for easy cleaning in between the fixed panel and door panel

HÜPPE Vista pure frameless Rectangular

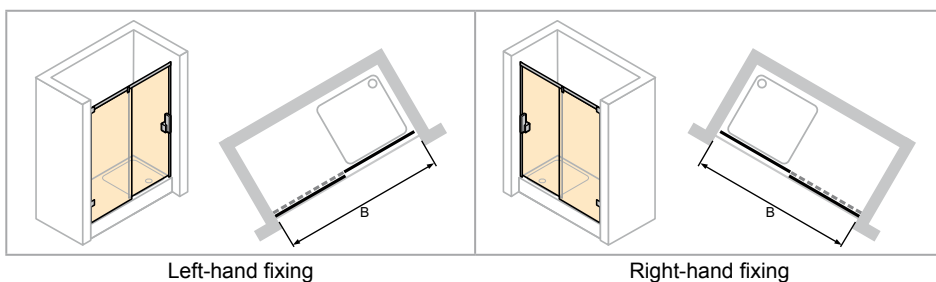

- Measurements must always be taken.
- Glass cut for compensating vertical wall tolerances are included in the base price
- Horizontal slopes for compensating building tolerances in the floor level not possible.
- Mirror glass (380/381): Please state in your order which segment should be produced with mirror glass. If this is not stated, the entire unit will be produced with mirror glass.

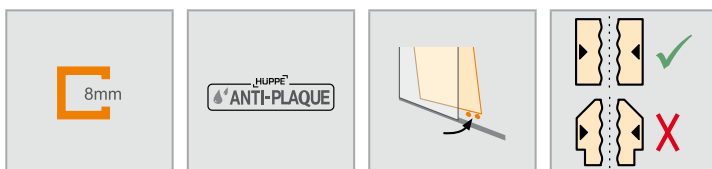

Sliding door, 1-panel with fixed segment in recess

Made-to-measure - Left-hand fixing

Height	Width B	Product no.	Base price
1200-2000	1000-1600	VR0009	2.379,-
	1601-2200	VR0008	2.985,-

Non-standard heights not available.

Individual segment widths not possible.



Made-to-measure - Right-hand fixing

Height	Width B	Product no.	Base price
1200-2000	1000-1600	VR0019	2.379,-
	1601-2200	VR0018	2.985,-

Non-standard heights not available.

Individual segment widths not possible.

Dim. Range: min. - max.

	
1200-2000	1000-2200

Colours - Panel options

Profile colours	Colour code	Extra charges	Panel options		without Anti-Plaque		with Anti-Plaque	
			Glass code	Extra charges	Glass code	Extra charges		
Chrome/chrome	C91	0,-	Clear	321	0,-	322	209,-	
			Karo	311	186,-	312	395,-	
			Sand Plus	315	428,-	316	637,-	
			Mirror glass	380	428,-	381	637,-	

HÜPPE Vista pure frameless Rectangular

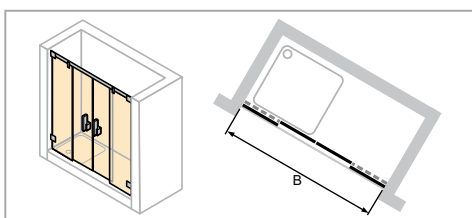

- Measurements must always be taken.
- Glass cut for compensating vertical wall tolerances are included in the base price
- Horizontal slopes for compensating building tolerances in the floor level not possible.
- Mirror glass (380/381): Please state in your order which segment should be produced with mirror glass. If this is not stated, the entire unit will be produced with mirror glass.

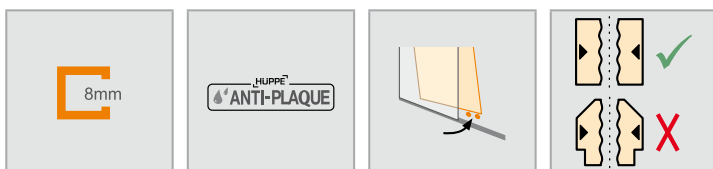

Sliding door, 2-panel with fixed segments in recess



Made-to-measure

Height	Width B	Product no.	Base price
1200-2000	1200-1800	VR0029	3.191,-
	1801-2400	VR0028	3.889,-

Non-standard heights not available.

Individual segment widths not possible.

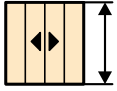
Dim. Range: min. - max.

	
1200-2000	1200-2400

Colours - Panel options

Profile colours	Colour code	Extra charges	Panel options	without Anti-Plaque		with Anti-Plaque	
				Glass code	Extra charges	Glass code	Extra charges
Chrome/chrome	C91	0,-	Clear	321	0,-	322	418,-
			Karo	311	371,-	312	789,-
			Sand Plus	315		316	
			Mirror glass	380	428,-	381	846,-

HÜPPE Vista pure frameless Rectangular

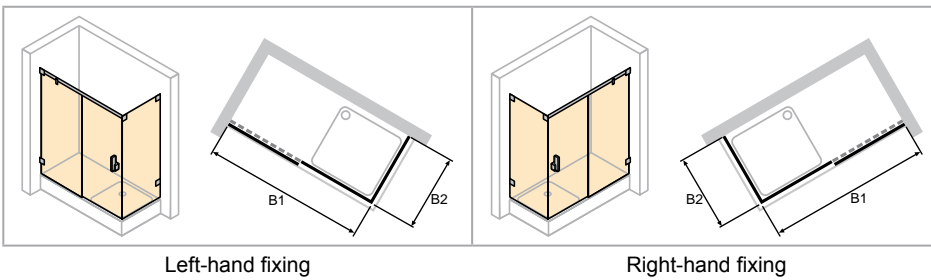

- Measurements must always be taken.
- Glass cut for compensating vertical wall tolerances are included in the base price
- Horizontal slopes for compensating building tolerances in the floor level not possible.
- Mirror glass (380/381): Please state in your order which segment should be produced with mirror glass. If this is not stated, the entire unit will be produced with mirror glass.
- Towel rail height can be selected individually and must be specified with the order. If nothing is specified, the towel rail is always delivered middle of glass (height and width).
- Installation of towel rail only possible on side panel.

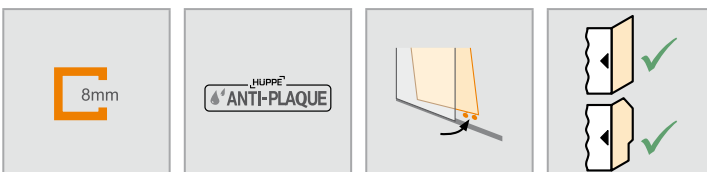

Sliding door, 1-panel with fixed segment and side panel

Made-to-measure - Left-hand fixing

Height	Door width B1	Width Side panel B2	Product no.	Base price
1200-2000	1000-1600	300-1200	VR0049	3.493,-
	1601-2200	300-1200	VR0048	4.100,-

Non-standard side panels not available

Non-standard heights not available.

Individual segment widths not possible.

Made-to-measure - Right-hand fixing

Height	Door width B1	Width Side panel B2	Product no.	Base price
1200-2000	1000-1600	300-1200	VR0059	3.493,-
	1601-2200	300-1200	VR0058	4.100,-

Non-standard side panels not available

Non-standard heights not available.

Individual segment widths not possible.

Dim. Range: min. - max.

1200-2000	1000-2200	300-1200

Special options

Special options		Extra charges
Towel rail (silver high-gloss)	T99	210,-

Colours - Panel options

Profile colours	Colour code	Extra charges	Panel options		without Anti-Plaque		with Anti-Plaque	
			Glass code	Extra charges	Glass code	Extra charges		
Chrome/chrome	C91	0,-	Clear	321	0,-	322	418,-	
			Karo	311	371,-	312	789,-	
			Sand Plus	315		316		
			Mirror glass	380	428,-	381	846,-	

HÜPPE Vista pure frameless Rectangular

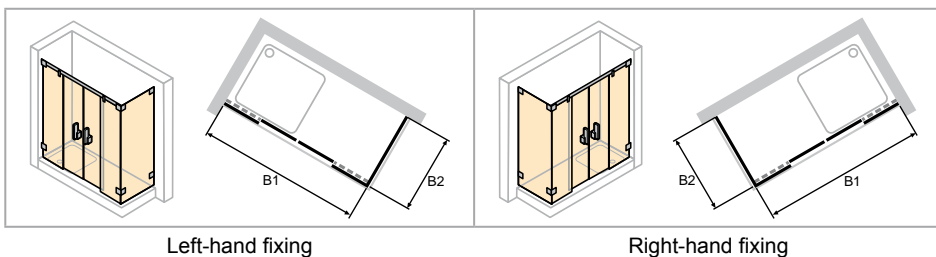

- Measurements must always be taken.
- Glass cut for compensating vertical wall tolerances are included in the base price
- Horizontal slopes for compensating building tolerances in the floor level not possible.
- Mirror glass (380/381): Please state in your order which segment should be produced with mirror glass. If this is not stated, the entire unit will be produced with mirror glass.
- Towel rail height can be selected individually and must be specified with the order. If nothing is specified, the towel rail is always delivered middle of glass (height and width).
- Installation of towel rail only possible on side panel.

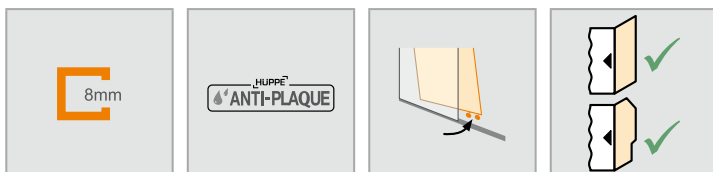

Sliding door, 2-panel with fixed segments and side panel

Made-to-measure - Left-hand fixing

Height	Door width B1	Width Side panel B2	Product no.	Base price
1200-2000	1200-1800	300-1200	VR0089	4.133,-
	1801-2400	300-1200	VR0088	4.832,-

Non-standard side panels not available

Non-standard heights not available.

Individual segment widths not possible.

Made-to-measure - Right-hand fixing

Height	Door width B1	Width Side panel B2	Product no.	Base price
1200-2000	1200-1800	300-1200	VR0099	4.133,-
	1801-2400	300-1200	VR0098	4.832,-

Non-standard side panels not available

Non-standard heights not available.

Individual segment widths not possible.

Dim. Range: min. - max.

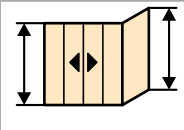
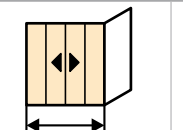
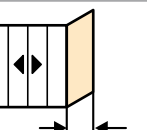
		
1200-2000	1200-2400	300-1200

Special options

Special options		Extra charges
Towel rail (silver high-gloss)	T99	210,-

Colours - Panel options

Profile colours	Colour code	Extra charges	Panel options		without Anti-Plaque		with Anti-Plaque	
			Glass code	Extra charges	Glass code	Extra charges		
Chrome/chrome	C91	0,-	Clear	321	0,-	322	418,-	
			Karo	311	371,-	312	789,-	
			Sand Plus	315		316		
			Mirror glass	380	428,-	381	846,-	

HÜPPE Vista pure frameless Rectangular

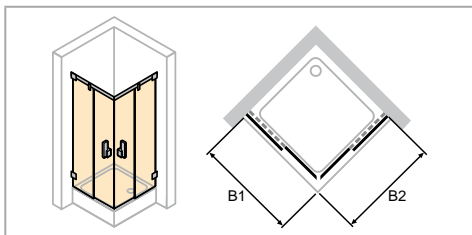

- Measurements must always be taken.
- Glass cut for compensating vertical wall tolerances are included in the base price
- Horizontal slopes for compensating building tolerances in the floor level not possible.
- Mirror glass (380/381): Please state in your order which segment should be produced with mirror glass.
If this is not stated, the entire unit will be produced with mirror glass.

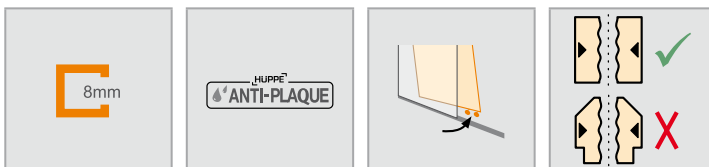

Sliding door corner entry

Made-to-measure

Height	Width B1	Width B2	Product no.	Base price
1200-2000	700-1200	700-1200	VR0159	3.191,-

Non-standard widths not available

Non-standard heights not available.

Individual segment widths not possible.

Dim. Range: min. - max.

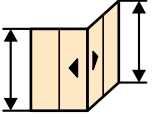
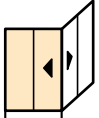
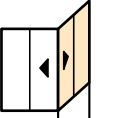
		
1200-2000	700-1200	700-1200

Colours - Panel options

Profile colours	Colour code	Extra charges	Panel options	without Anti-Plaque		with Anti-Plaque	
				Glass code	Extra charges	Glass code	Extra charges
Chrome/chrome	C91	0,-	Clear	321	0,-	322	418,-
			Karo	311	371,-	312	789,-
			Sand Plus	315		316	
			Mirror glass	380	428,-	381	846,-

HÜPPE Vista pure frameless Rectangular

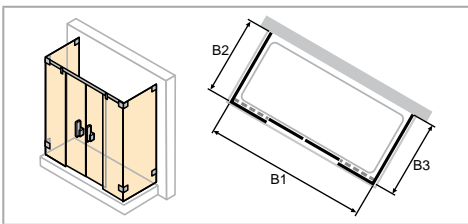

- Measurements must always be taken.
- Glass cut for compensating vertical wall tolerances are included in the base price
- Horizontal slopes for compensating building tolerances in the floor level not possible.
- Mirror glass (380/381): Please state in your order which segment should be produced with mirror glass. If this is not stated, the entire unit will be produced with mirror glass.
- Towel rail height can be selected individually and must be specified with the order. If nothing is specified, the towel rail is always delivered middle of glass (height and width).
- Installation of towel rail only possible on side panel.

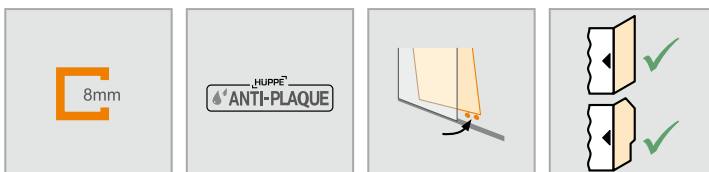

Sliding door, 2-panel with fixed segments and two side panels as U-shaped enclosure

Made-to-measure

Height	Door width B1	Width Side panel B2/B3	Product no.	Base price
1200-2000	1200-1800	300-1200	VR0109	5.161,-
	1801-2400	300-1200	VR0108	5.860,-

Non-standard side panels not available

Non-standard heights not available.

Individual segment widths not possible.

Dim. Range: min. - max.

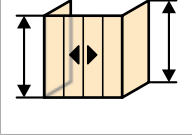
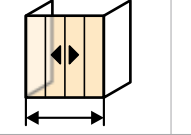
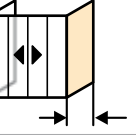
		
1200-2000	1200-2400	300-1200

Special options

Special options		Extra charges
Towel rail (silver high-gloss)	T99	210,-

Colours - Panel options

Profile colours	Colour code	Extra charges	Panel options		without Anti-Plaque		with Anti-Plaque	
			Glass code	Extra charges	Glass code	Extra charges		
Chrome/chrome	C91	0,-	Clear	321	0,-	322	418,-	
			Karo	311	371,-	312	789,-	
			Sand Plus	315		316		
			Mirror glass	380	428,-	381	846,-	

HÜPPE Vista pure, partially framed



HÜPPE Vista pure partially framed model overview - Base price

Rectangular

Sliding door, 1-panel with fixed segment in recess

Sliding door, 2-panel with fixed segments in recess

Sliding door, 1-panel with fixed segment and side panel

Sliding door, 2-panel with fixed segments and side panel

Sliding door corner entry

Sliding door, 2-panel with fixed segments and two side panels as U-shaped enclosure

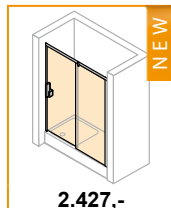

2.427,-

P.4-P.5



3.251,-

P.6-P.7

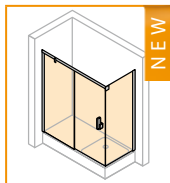

3.556,-

P.8-P.11

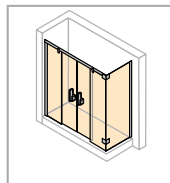

4.214,-

P.12-P.13

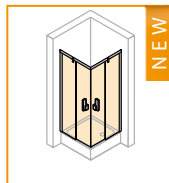

3.191,-

P.14-P.15

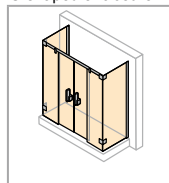

5.262,-

P.16-P.17

NEW

New standard part numbers.

All prices in EURO exclusive of VAT. All dimensions in mm

P.1

HÜPPE Vista pure, partially framed



Product details



Partly framed wall attachment in unique angular design



Modern handle design



Innovative roller guide



Can be installed with or without drip deflector strip



Easy release mechanism at the base of the door for easy cleaning in between the fixed panel and door panel

HÜPPE Vista pure partially framed Rectangular

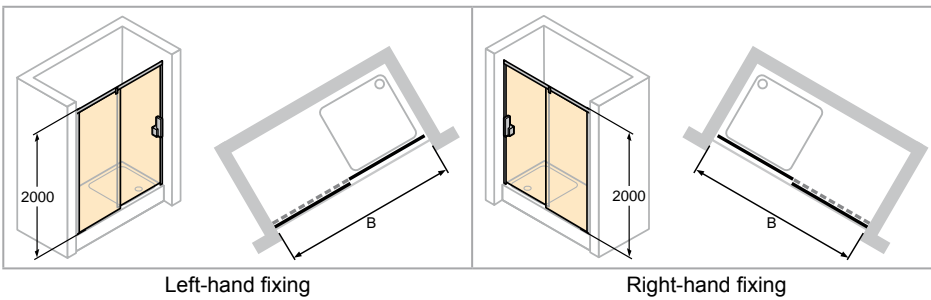

- Mirror glass (380/381) only available for made-to-measure products.
- Mirror glass (380/381): Please state in your order which segment should be produced with mirror glass. If this is not stated, the entire unit will be produced with mirror glass.
- For technical information, see Profile Colours and Panel Options section.

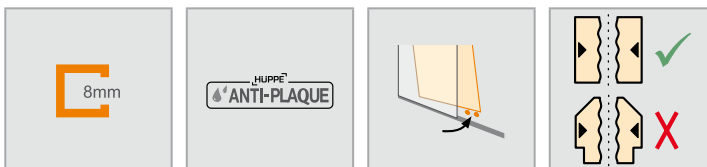
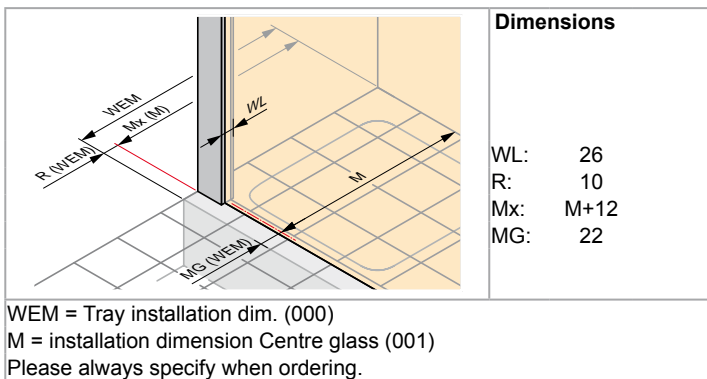

Sliding door, 1-panel with fixed segment in recess

Left-hand fixing

Height	Model	WEM B	M (middle of glass) B	Entry width	Width of fixed segment	Product no.	Base price
2000	1200	1185-1200	1185-1200	500	560-575	VT0400	2.427,-
	1300	1285-1300	1285-1300	550	610-625	VT0404	
	1400	1385-1400	1385-1400	600	660-675	VT0401	
	1500	1485-1500	1485-1500	650	710-725	VT0405	
	1600	1585-1600	1585-1600	700	760-775	VT0402	
	1700	1685-1700	1685-1700	750	810-825	VT0406	2.500,-
	1800	1785-1800	1785-1800	800	860-875	VT0403	

Made-to-measure - Left-hand fixing

Height	Width B	Product no.	Base price
1200-2000	1000-1600	VT0009	3.154,-
	1601-2200	VT0008	3.760,-

Adjustment range = dimensions - 8mm / + 7mm

Non-standard heights not available.

Individual segment widths not possible.

Right-hand fixing

Height	Model	WEM B	M (middle of glass) B	Entry width	Width of fixed segment	Product no.	Base price
2000	1200	1185-1200	1185-1200	500	560-575	VT0410	2.427,-
	1300	1285-1300	1285-1300	550	610-625	VT0414	
	1400	1385-1400	1385-1400	600	660-675	VT0411	
	1500	1485-1500	1485-1500	650	710-725	VT0415	
	1600	1585-1600	1585-1600	700	760-775	VT0412	
	1700	1685-1700	1685-1700	750	810-825	VT0416	2.500,-
	1800	1785-1800	1785-1800	800	860-875	VT0413	

Made-to-measure - Right-hand fixing

Height	Width B	Product no.	Base price
1200-2000	1000-1600	VT0019	3.154,-
	1601-2200	VT0018	3.760,-

Adjustment range = dimensions - 8mm / + 7mm

Non-standard heights not available.

Individual segment widths not possible.

Dim. Range: min. - max.

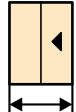
	
1200-2000	1000-2200

Colours - Panel options

Profile colours	Colour code	Extra charges	Panel options	without Anti-Plaque		with Anti-Plaque	
				Glass code	Extra charges	Glass code	Extra charges
Chrome/chrome	C91	0,-	Clear	321	0,-	322	209,-
			Karo	311	186,-	312	395,-
			Sand Plus	315		316	
			Mirror glass	380	428,-	381	637,-

HÜPPE Vista pure partially framed Rectangular

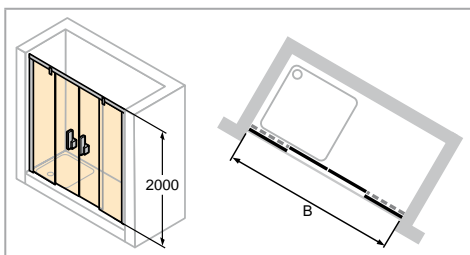

- Mirror glass (380/381) only available for made-to-measure products.
- Mirror glass (380/381): Please state in your order which segment should be produced with mirror glass. If this is not stated, the entire unit will be produced with mirror glass.
- For technical information, see Profile Colours and Panel Options section.

Dimensions	
	WL: 26 R: 10 Mx: M+12 MG: 22
WEM = Tray installation dim. (000) M = installation dimension Centre glass (001) Please always specify when ordering.	

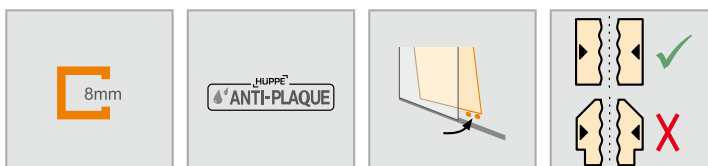

Sliding door, 2-panel with fixed segments in recess

Height	Model	WEM B	M (middle of glass) B	Entry width	Width of fixed segment	Product no.	Base price
2000	1400	1380-1410	1380-1410	600	320-335	VT0420	3.251,-
	1600	1580-1610	1580-1610	700	370-385	VT0421	
	1700	1680-1710	1680-1710	750	395-410	VT0423	
	1800	1780-1810	1780-1810	800	420-435	VT0422	
	2000	1980-2010	1980-2010	900	470-482	VT0424	3.349,-

Made-to-measure



Height	Width B	Product no.	Base price
1200-2000	1200-1800	VT0029	4.226,-
	1801-2400	VT0028	4.925,-

Adjustment range = dimensions - 15mm / + 15mm

Non-standard heights not available.

Individual segment widths not possible.

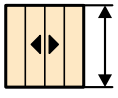
Dim. Range: min. - max.

	
1200-2000	1200-2400

Colours - Panel options

Profile colours	Colour code	Extra charges	Panel options		without Anti-Plaque		with Anti-Plaque	
			Glass code	Extra charges	Glass code	Extra charges		
Chrome/chrome	C91	0,-	Clear	321	0,-	322	418,-	
			Karo	311	371,-	312	789,-	
			Sand Plus	315		316		
			Mirror glass	380	428,-	381	846,-	

HÜPPE Vista pure partially framed Rectangular

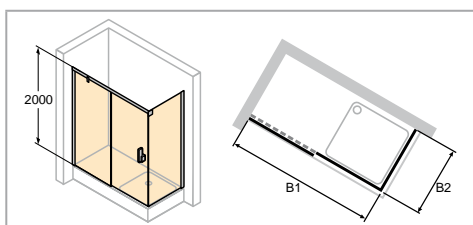

Left-hand fixing

- Towel rail height can be selected individually and must be specified with the order. If nothing is specified, the towel rail is always delivered middle of glass (height and width).
- Installation of towel rail only possible on side panel.
- Mirror glass (380/381) only available for made-to-measure products.
- Mirror glass (380/381): Please state in your order which segment should be produced with mirror glass. If this is not stated, the entire unit will be produced with mirror glass.
- For technical information, see Profile Colours and Panel Options section.

	<p>Dimensions</p> <p>WL: 26 R: 10 Mx: M+12 MG: 22</p>
<p>WEM = Tray installation dim. (000) M = installation dimension Centre glass (001) Please always specify when ordering.</p>	

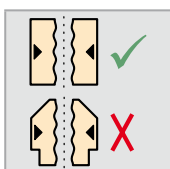
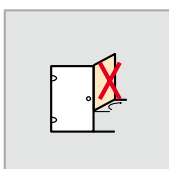
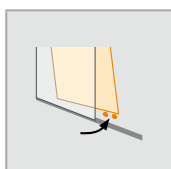
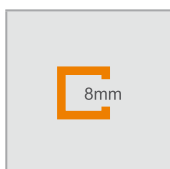

Sliding door, 1-panel with fixed segment and side panel

Left-hand fixing

Height	Model B1/B2	WEM Door width B1	WEM Side panel B2	M (middle of glass) Door B1	M (middle of glass) Side panel B2	Entry width	Width of fixed segment	Product no.	Base price
2000	1000x800	985-1000	785-800	963-978	763-778	400	450-465	VT0440	3.556,-
	1200x750	1185-1200	735-750	1163-1178	713-728	500	550-565	VT0462	
	1200x800	1185-1200	785-800	1163-1178	763-778	500	550-565	VT0441	
	1200x900	1185-1200	885-900	1163-1178	863-878	500	550-565	VT0463	
	1200x1000	1185-1200	985-1000	1163-1178	963-978	500	550-565	VT0464	3.627,-
	1400x750	1385-1400	735-750	1363-1378	713-728	600	650-665	VT0465	
	1400x800	1385-1400	785-800	1363-1378	763-778	600	650-665	VT0447	
	1400x900	1385-1400	885-900	1363-1378	863-878	600	650-665	VT0442	
	1400x1000	1385-1400	985-1000	1363-1378	963-978	600	650-665	VT0466	3.704,-
	1500x750	1485-1500	735-750	1463-1478	713-728	650	700-715	VT0467	
	1500x800	1485-1500	785-800	1463-1478	763-778	650	700-715	VT0468	
	1500x900	1485-1500	885-900	1463-1478	863-878	650	700-715	VT0443	
	1500x1000	1485-1500	985-1000	1463-1478	963-978	650	700-715	VT0469	3.778,-
	1600x750	1585-1600	735-750	1563-1578	713-728	700	750-765	VT0570	
	1600x800	1585-1600	785-800	1563-1578	763-778	700	750-765	VT0449	
	1600x900	1585-1600	885-900	1563-1578	863-878	700	750-765	VT0571	
1600x1000	1585-1600	985-1000	1563-1578	963-978	700	750-765	VT0572		

Made-to-measure - Left-hand fixing

Height	Door width B1	Width Side panel B2	Product no.	Base price
1200-2000	1000-1600	300-1200	VT0049	4.542,-
	1601-2200	300-1200	VT0048	5.148,-

Adjustment range = dimensions - 8mm / + 7mm

Non-standard side panels not available

Non-standard heights not available.

Individual segment widths not possible.

Dim. Range: min. - max.

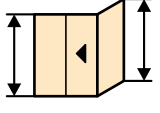
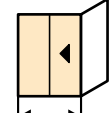
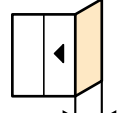
		
1200-2000	1000-2200	300-1200

Special options

Special options		Extra charges
Towel rail (silver high-gloss)	T99	210,-

Colours - Panel options

Profile colours	Colour code	Extra charges	Panel options		without Anti-Plaque		with Anti-Plaque	
			Glass code	Extra charges	Glass code	Extra charges		
Chrome/chrome	C91	0,-	Clear	321	0,-	322	418,-	
			Karo	311	371,-	312	789,-	
			Sand Plus	315		316		
			Mirror glass	380	428,-	381	846,-	

HÜPPE Vista pure partially framed Rectangular

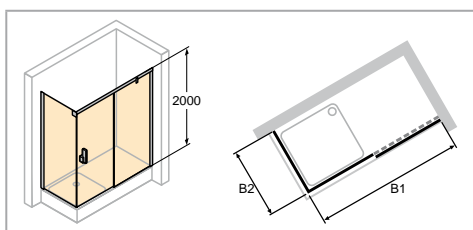

Right-hand fixing

- Towel rail height can be selected individually and must be specified with the order. If nothing is specified, the towel rail is always delivered middle of glass (height and width).
- Installation of towel rail only possible on side panel.
- Mirror glass (380/381) only available for made-to-measure products.
- Mirror glass (380/381): Please state in your order which segment should be produced with mirror glass. If this is not stated, the entire unit will be produced with mirror glass.
- For technical information, see Profile Colours and Panel Options section.

	<p>Dimensions</p> <p>WL: 26 R: 10 Mx: M+12 MG: 22</p>
<p>WEM = Tray installation dim. (000) M = installation dimension Centre glass (001) Please always specify when ordering.</p>	

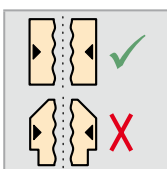
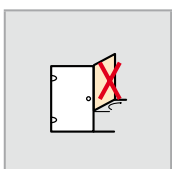
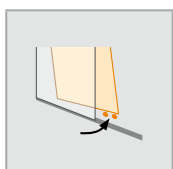
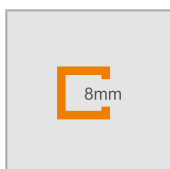

Sliding door, 1-panel with fixed segment and side panel

Right-hand fixing

Height	Model B1/B2	WEM Door width B1	WEM Side panel B2	M (middle of glass) Door B1	M (middle of glass) Side panel B2	Entry width	Width of fixed segment	Product no.	Base price
2000	1000x800	985-1000	785-800	963-978	763-778	400	450-465	VT0450	3.556,-
	1200x750	1185-1200	735-750	1163-1178	713-728	500	550-565	VT0472	
	1200x800	1185-1200	785-800	1163-1178	763-778	500	550-565	VT0451	
	1200x900	1185-1200	885-900	1163-1178	863-878	500	550-565	VT0473	
	1200x1000	1185-1200	985-1000	1163-1178	963-978	500	550-565	VT0474	3.627,-
	1400x750	1385-1400	735-750	1363-1378	713-728	600	650-665	VT0475	
	1400x800	1385-1400	785-800	1363-1378	763-778	600	650-665	VT0457	
	1400x900	1385-1400	885-900	1363-1378	863-878	600	650-665	VT0452	
	1400x1000	1385-1400	985-1000	1363-1378	963-978	600	650-665	VT0476	3.704,-
	1500x750	1485-1500	735-750	1463-1478	713-728	650	700-715	VT0477	
	1500x800	1485-1500	785-800	1463-1478	763-778	650	700-715	VT0478	
	1500x900	1485-1500	885-900	1463-1478	863-878	650	700-715	VT0453	
	1500x1000	1485-1500	985-1000	1463-1478	963-978	650	700-715	VT0479	3.778,-
	1600x750	1585-1600	735-750	1563-1578	713-728	700	750-765	VT0580	
	1600x800	1585-1600	785-800	1563-1578	763-778	700	750-765	VT0459	
	1600x900	1585-1600	885-900	1563-1578	863-878	700	750-765	VT0581	
1600x1000	1585-1600	985-1000	1563-1578	963-978	700	750-765	VT0582		

Made-to-measure - Right-hand fixing

Height	Door width B1	Width Side panel B2	Product no.	Base price
1200-2000	1000-1600	300-1200	VT0059	4.542,-
	1601-2200	300-1200	VT0058	5.148,-

Adjustment range = dimensions - 8mm / + 7mm

Non-standard side panels not available

Non-standard heights not available.

Individual segment widths not possible.

Dim. Range: min. - max.

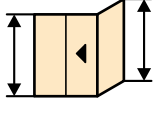
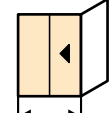
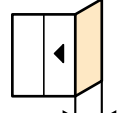
		
1200-2000	1000-2200	300-1200

Special options

Special options		Extra charges
Towel rail (silver high-gloss)	T99	210,-

Colours - Panel options

Profile colours	Colour code	Extra charges	Panel options	
			without Anti-Plaque Glass code	with Anti-Plaque Glass code
Chrome/chrome	C91	0,-	321	322
			0,-	418,-
			311	312
			371,-	789,-
			315	316
			428,-	846,-
			380	381

HÜPPE Vista pure partially framed Rectangular

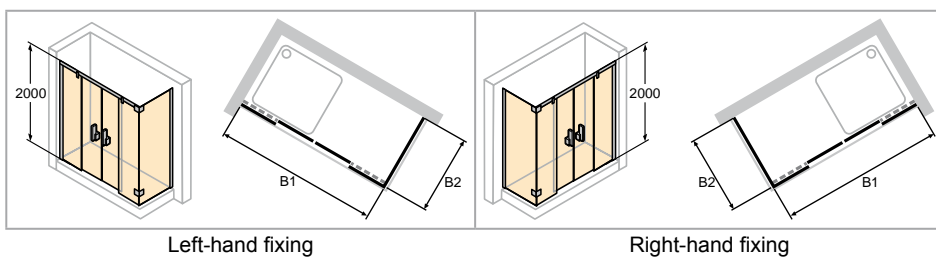

- Towel rail height can be selected individually and must be specified with the order. If nothing is specified, the towel rail is always delivered middle of glass (height and width).
- Installation of towel rail only possible on side panel.
- Mirror glass (380/381) only available for made-to-measure products.
- Mirror glass (380/381): Please state in your order which segment should be produced with mirror glass. If this is not stated, the entire unit will be produced with mirror glass.
- For technical information, see Profile Colours and Panel Options section.

Dimensions	
	WL: 26 R: 10 Mx: M+12 MG: 22
WEM = Tray installation dim. (000) M = installation dimension Centre glass (001) Please always specify when ordering.	

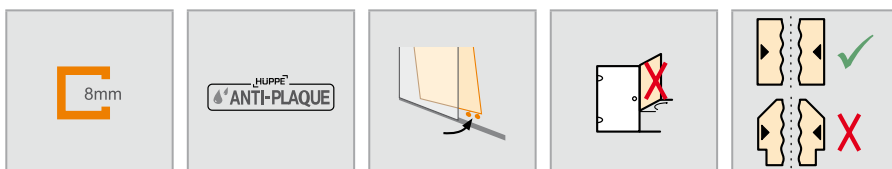

Sliding door, 2-panel with fixed segments and side panel

Left-hand fixing

Height	Model B1/B2	WEM Door width B1	WEM Side panel B2	M (middle of glass) Door B1	M (middle of glass) Side panel B2	Entry width	Width of fixed segment	Product no.	Base price
2000	1200x800	1185-1200	785-800	1163-1178	763-778	500	265-280	VT0480	4.214,-
	1400x900	1385-1400	885-900	1363-1378	863-878	600	315-330	VT0481	
	1500x900	1485-1500	885-900	1463-1478	863-878	650	340-355	VT0482	
	1600x1000	1585-1600	985-1000	1563-1578	963-978	700	365-385	VT0483	
	1800x1000	1785-1800	985-1000	1763-1778	963-978	800	415-430	VT0484	

Made-to-measure - Left-hand fixing

Height	Door width B1	Width Side panel B2	Product no.	Base price
1200-2000	1200-1800	300-1200	VT0089	5.477,-
	1801-2400	300-1200	VT0088	6.176,-

Adjustment range = dimensions - 8mm / + 7mm

Non-standard side panels not available

Non-standard heights not available.

Individual segment widths not possible.

Right-hand fixing

Height	Model B1/B2	WEM Door width B1	WEM Side panel B2	M (middle of glass) Door B1	M (middle of glass) Side panel B2	Entry width	Width of fixed segment	Product no.	Base price
2000	1200x800	1185-1200	785-800	1163-1178	763-778	500	265-280	VT0490	4.214,-
	1400x900	1385-1400	885-900	1363-1378	863-878	600	315-330	VT0491	
	1500x900	1485-1500	885-900	1463-1478	863-878	650	340-355	VT0492	
	1600x1000	1585-1600	985-1000	1563-1578	963-978	700	365-385	VT0493	
	1800x1000	1785-1800	985-1000	1763-1778	963-978	800	415-430	VT0494	

Made-to-measure - Right-hand fixing

Height	Door width B1	Width Side panel B2	Product no.	Base price
1200-2000	1200-1800	300-1200	VT0099	5.477,-
	1801-2400	300-1200	VT0098	6.176,-

Adjustment range = dimensions - 8mm / + 7mm

Non-standard side panels not available

Non-standard heights not available.

Individual segment widths not possible.

Dim. Range: min. - max.

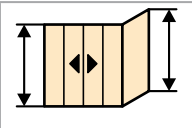
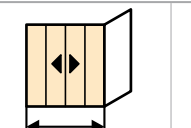
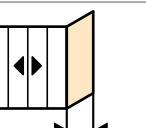
		
1200-2000	1200-2400	300-1200

Special options

Special options		Extra charges
Towel rail (silver high-gloss)	T99	210,-

Colours - Panel options

Profile colours	Colour code	Extra charges	Panel options		without Anti-Plaque		with Anti-Plaque	
			Glass code	Extra charges	Glass code	Extra charges		
Chrome/chrome	C91	0,-	Clear	321	0,-	322	418,-	
			Karo	311	371,-	312	789,-	
			Sand Plus	315		316		
			Mirror glass	380	428,-	381	846,-	

HÜPPE Vista pure partially framed Rectangular

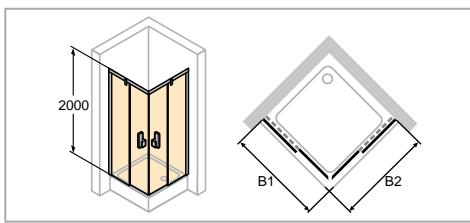

- Mirror glass (380/381) only available for made-to-measure products.
- Mirror glass (380/381): Please state in your order which segment should be produced with mirror glass. If this is not stated, the entire unit will be produced with mirror glass.
- For technical information, see Profile Colours and Panel Options section.

	<p>Dimensions</p> <p>WL: 26 R: 10 Mx: M+12 MG: 22</p>
<p>WEM = Tray installation dim. (000) M = installation dimension Centre glass (001) Please always specify when ordering.</p>	

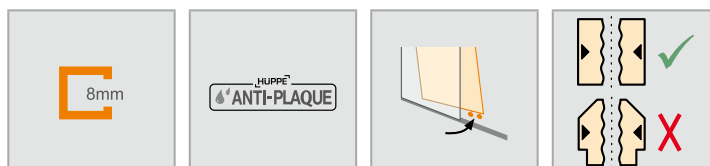

Sliding door corner entry

Height	Model B1/B2	WEM B1	WEM B2	M (middle of glass) B1	M (middle of glass) B2	Entry width	Width of fixed segment	Product no.	Base price
2000	800x800	785-800	785-800	763-778	763-778	431	335-350	VT0550	3.191,-
	900x900	885-900	885-900	863-878	863-878	502	385-400	VT0551	
	1000x1000	985-1000	985-1000	963-978	963-978	572	435-450	VT0552	3.317,-
	1200x1200	1185-1200	1185-1200	1163-1178	1163-1178	713	535-550	VT0557	3.482,-
	900x750	885-900	735-750	863-878	713-728	450	385-400/310-330	VT0553	3.191,-
	750x900	735-750	885-900	713-728	863-878	450	310-330/385-400	VT0554	
	1200x800	1185-1200	785-800	1163-1178	763-778	572	535-550/335-350	VT0555	3.380,-
800x1200	785-800	1185-1200	763-778	1163-1178	572	335-350/535-550	VT0556		

Made-to-measure

Height	Width B1	Width B2	Product no.	Base price
1200-2000	700-1200	700-1200	VT0159	4.146,-

Adjustment range = dimensions - 8mm / + 7mm

Non-standard widths not available

Non-standard heights not available.

Individual segment widths not possible.

Dim. Range: min. - max.

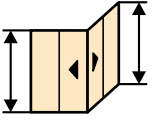
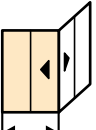
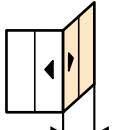
		
1200-2000	700-1200	700-1200

Colours - Panel options

Profile colours	Colour code	Extra charges	Panel options	without Anti-Plaque		with Anti-Plaque	
				Glass code	Extra charges	Glass code	Extra charges
Chrome/chrome	C91	0,-	Clear	321	0,-	322	418,-
			Karo	311	371,-	312	789,-
			Sand Plus	315		316	
			Mirror glass	380	428,-	381	846,-

HÜPPE Vista pure partially framed Rectangular

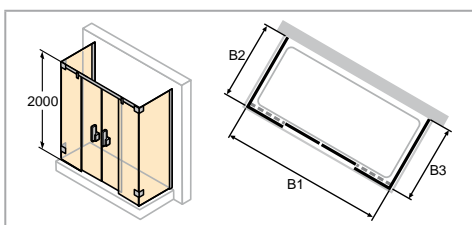

- Towel rail height can be selected individually and must be specified with the order. If nothing is specified, the towel rail is always delivered middle of glass (height and width).
- Installation of towel rail only possible on side panel.
- Mirror glass (380/381) only available for made-to-measure products.
- Mirror glass (380/381): Please state in your order which segment should be produced with mirror glass. If this is not stated, the entire unit will be produced with mirror glass.
- For technical information, see Profile Colours and Panel Options section.

Dimensions	
	WL: 26 R: 10 Mx: M+12 MG: 22
WEM = Tray installation dim. (000) M = installation dimension Centre glass (001) Please always specify when ordering.	

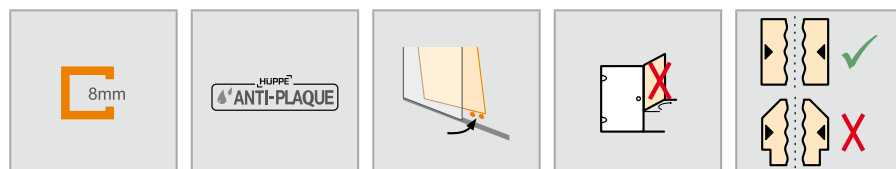

Sliding door, 2-panel with fixed segments and two side panels as U-shaped enclosure

Height	Model	WEM GTN B1	WEM GTS B2/B3	M (middle of glass) GTN B1	M (middle of glass) GTS B2/B3	Entry width	Width of fixed segment	Product no.	Base price
2000	1400x900	1400	885-900	1356	863-878	565	305	VT0500	5.262,-
	1500x900	1500	885-900	1456	863-878	615	330	VT0501	
	1600x1000	1600	985-1000	1556	963-978	665	355	VT0502	
	1800x1000	1800	985-1000	1756	963-978	765	405	VT0503	

Made-to-measure

Height	Door width B1	Width Side panel B2/B3	Product no.	Base price
1200-2000	1200-1800	300-1200	VT0109	6.841,-
	1801-2400	300-1200	VT0108	7.540,-

Adjustment range = dimensions - 8mm / + 7mm

Non-standard side panels not available

Non-standard heights not available.

Individual segment widths not possible.

Dim. Range: min. - max.

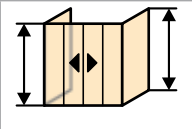
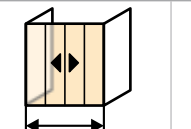
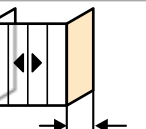
		
1200-2000	1200-2400	300-1200

Special options

Special options		Extra charges
Towel rail (silver high-gloss)	T99	210,-

Colours - Panel options

Profile colours	Colour code	Extra charges	Panel options		without Anti-Plaque		with Anti-Plaque	
			Glass code	Extra charges	Glass code	Extra charges		
Chrome/chrome	C91	0,-	Clear	321	0,-	322	418,-	
			Karo	311	371,-	312	789,-	
			Sand Plus	315		316		
			Mirror glass	380	428,-	381	846,-	

HÜPPE Studio Paris elegance frameless model overview - base price

HÜPPE Studio Berlin pure frameless model overview - base price

Rectangular

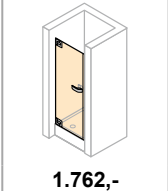
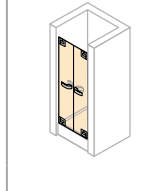
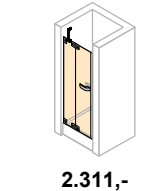
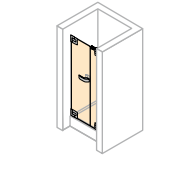
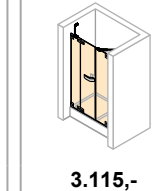
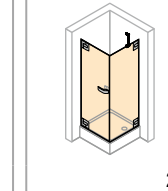
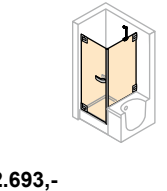
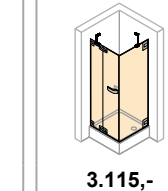
Swing door in recess  1.762,- Q.12-Q.13	Two-way door in recess  Q.14-Q.15	Swing door with fixed segment in recess  2.311,- Q.16-Q.17	Swing door with additional section in recess  Q.18-Q.19	Swing door with fixed segment and additional section in recess  3.115,- Q.20-Q.21	Swing door with side panel  Q.22-Q.23	Swing door with short side panel on bathtub  Q.24-Q.25	Swing door with fixed segment and side panel  3.115,- Q.26-Q.27
---	--	---	--	--	---	---	--

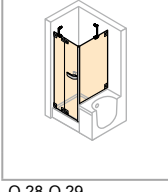
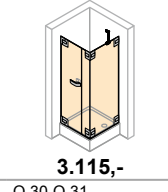
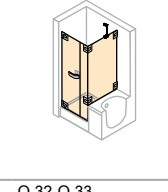
Swing door with fixed segment and shortened side panel on bathtub  Q.28-Q.29	Swing door with additional section and side panel  3.115,- Q.30-Q.31	Swing door with additional section and shortened side panel on bathtub  Q.32-Q.33
--	---	--

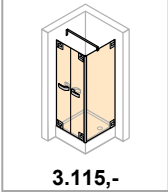
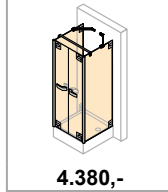
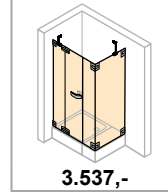
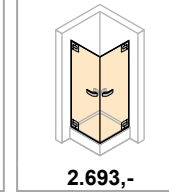
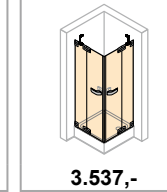
Two-way door with side panel  3.115,- Q.34-Q.35	Two-way door with two side panels as U-shaped enclosure  4.380,- Q.36-Q.37	Swing door with fixed segment, with additional section and side panel  3.537,- Q.38-Q.39	Swing door corner entry  2.693,- Q.40-Q.41	Swing door corner entry with fixed segments  3.537,- Q.42-Q.43
--	--	--	--	--

Quadrant

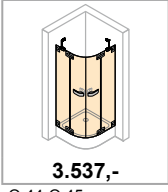
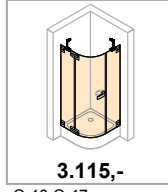
Swing door with fixed segments, 2-panel  3.537,- Q.44-Q.45	Swing door with fixed segments, 1-panel  3.115,- Q.46-Q.47
--	---

Pentagonal

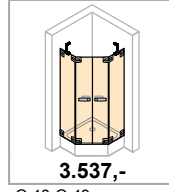
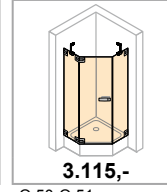
Swing door with fixed segments, 2-panel  3.537,- Q.48-Q.49	Swing door with fixed segments, 1-panel  3.115,- Q.50-Q.51
---	---

HÜPPE Studio Paris elegance frameless model overview - base price

HÜPPE Studio Berlin pure frameless model overview - base price

Walk-In

Free standing side panel

Free-standing side panel

Walk-In model 1

Walk-In model 2

Walk-In model 3

Walk-In model 4

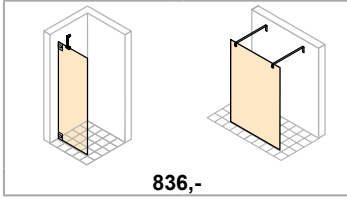

836,-

S.30-S.31

S.32-S.33

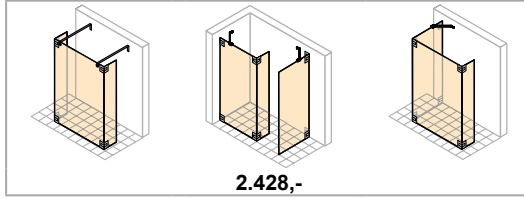

2.428,-

S.34-S.35

S.36-S.37

S.38-S.39

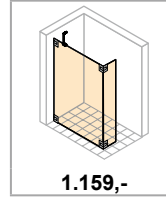

1.159,-

S.40-S.41

Bath-top shower screen

1-panel

1-panel with fixed segment

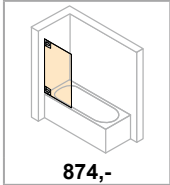

874,-

T.40-T.41

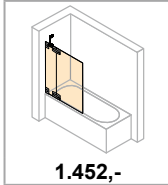

1.452,-

T.42-T.43

HÜPPE Studio Paris elegance frameless
HÜPPE Studio Berlin pure frameless











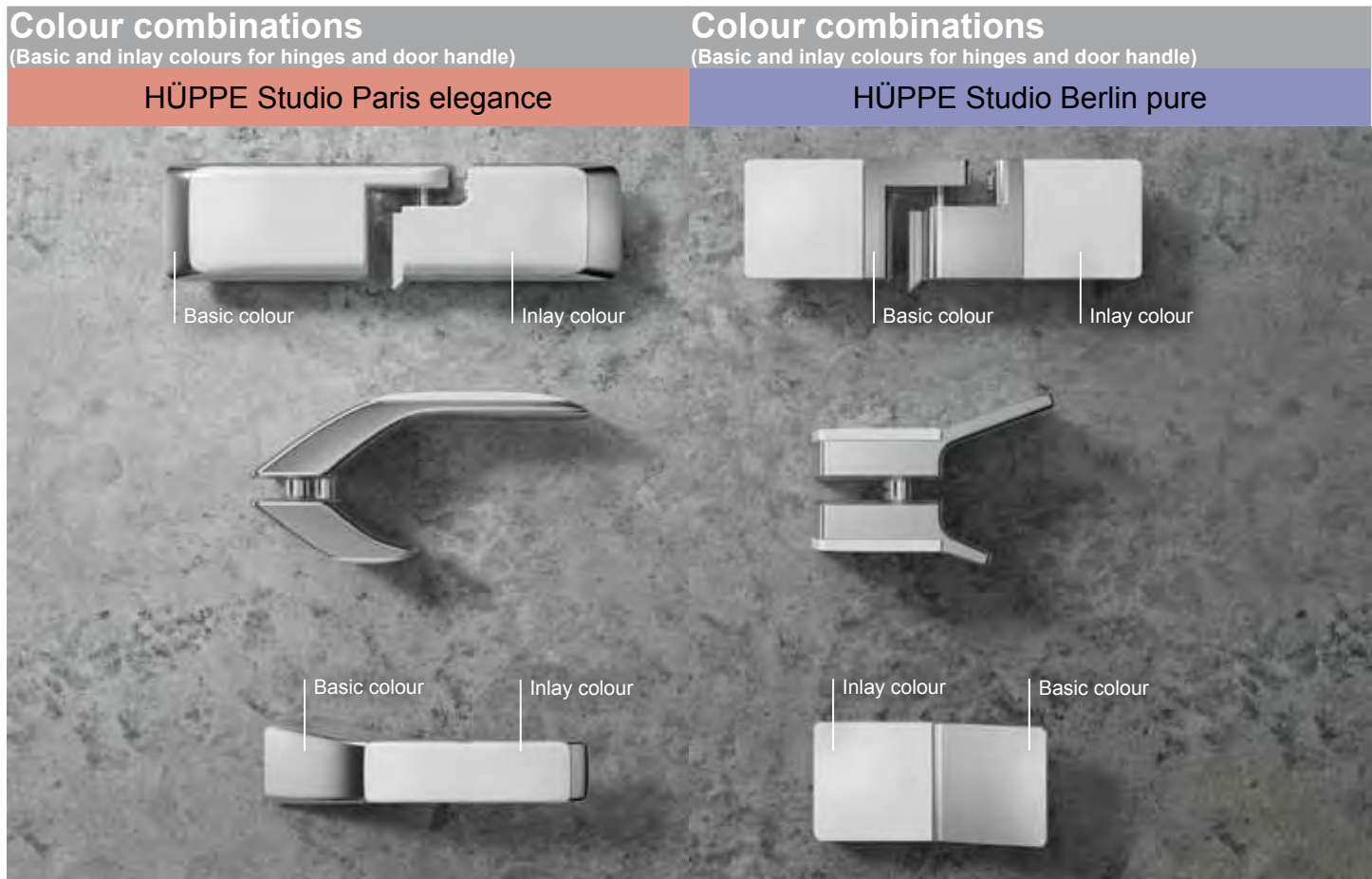



HÜPPE STUDIO

Our masterpiece.

HÜPPE Studio Paris elegance frameless basic and inlay colours
HÜPPE Studio Berlin pure frameless basic and inlay colours



Basic and inlay colours (in any combination) Examples: with basic colour chrome		Basic and inlay colours (in any combination) Examples: with basic colour chrome	
HÜPPE Studio Paris elegance		HÜPPE Studio Berlin pure	
 <p>Basic colour: chrome Inlay colour: white</p>	 <p>Basic colour: chrome Inlay colour: high-grade matt chrome</p>	 <p>Basic colour: chrome Inlay colour: white</p>	 <p>Basic colour: chrome Inlay colour: high-grade matt chrome</p>
 <p>Basic colour: chrome Inlay colour: chrome</p>	 <p>Basic colour: chrome Inlay colour: black</p>	 <p>Basic colour: chrome Inlay colour: chrome</p>	 <p>Basic colour: chrome Inlay colour: black</p>
 <p>Basic colour: chrome Inlay colour: brilliant gold</p>			 <p>Basic colour: chrome Inlay colour: brilliant gold</p>

Product details



Wall bracket HÜPPE Studio Paris elegance (outside)



Wall bracket HÜPPE Studio Paris elegance (inside)



Corner connector HÜPPE Studio Paris elegance



Wall bracket HÜPPE Studio Berlin pure (outside)



Wall bracket HÜPPE Studio Berlin pure (inside)



Corner connector HÜPPE Studio Berlin pure

Frameless version with wall bracket or corner connector. Completely flush-fitting on the interior for easy cleaning.



Installation with drip deflector strip



Installation without drip deflector strip for barrier-free entry



Innovative chrome-effect sealing strips



Bow-shaped handle HÜPPE Studio Paris elegance (available as an option)



Bow-shaped handle HÜPPE Studio Berlin pure (available as an option)

NEW: Customised colours and surfaces



Old brass



Black Edition



High grade brass



Stainless steel look



Custom colour overview

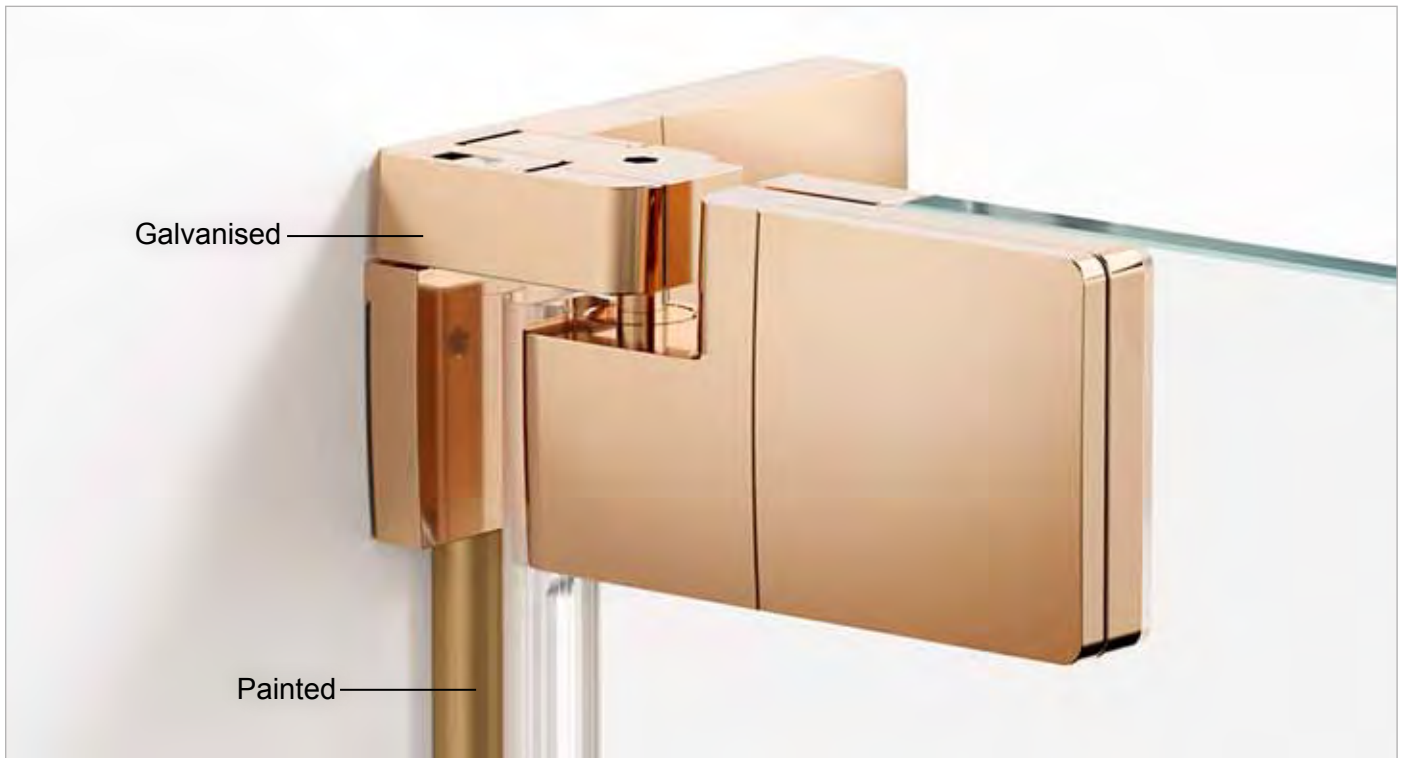

Because of the different materials used, a galvanised surface cannot be offered for all components. Therefore some parts are painted in a similar colour. You can find an overview in the table below.

HÜPPE Studio Paris elegance frameless HÜPPE Studio Berlin pure frameless

Basic colour	Individual RAL colours	Customised colours and surfaces			
		999			123
Colour code	998	Stainless steel look	Old brass	High grade brass	Black Edition
Hinges/inlays	RAL-painted	Stainless steel look	Old brass	High grade brass	painted
Standard handle, bow-shaped handle	RAL-painted	Stainless steel look	Old brass	High grade brass	painted
Stabilizer, connectors, cross bar	RAL-painted	Stainless steel look	Old brass	High grade brass	painted
Cross bar profile	RAL-painted	High-gloss silver	painted bronze	painted pearl gold	painted
Drip deflector strip/connectors	RAL-painted	High-gloss silver	painted bronze	painted pearl gold	painted
Profiles e.g. design profile, recess profile	RAL-painted	High-gloss silver	painted bronze	painted pearl gold	painted

IMPORTANT NOTE:

T-piece adapter and cover cap for external flush-fitting wall bracket ONLY IN CHROME!

HÜPPE Studio Paris elegance frameless panel options

HÜPPE Studio Berlin pure frameless panel options



Nature

Panel options	Glass code	1 or 2 panels Supplements per unit	3 or 4 panels Supplements per unit
Nature Anti-Plaque sand-blasted decor	366	353,-	706,-

- Sand-blasted decor dimensions: height 1400mm, position starting from bottom
- not available for quadrant models
- Due to technical production reasons, the decor may be offset from panel to panel.

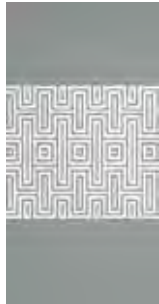

Orient

Panel options	Glass code	Supplements per unit	Supplements per unit
Orient Anti-Plaque sand-blasted decor	305	353,-	706,-

- Sand-blasted decor dimensions: height 800mm, position central relative to unit height
- not available for quadrant models
- Due to technical production reasons, the decor may be offset from panel to panel.



Liquid

Panel options	Glass code	Supplements per unit	Supplements per unit
Liquid Anti-Plaque sand-blasted decor	303	353,-	706,-

- Sand-blasted decor dimensions: height 830mm, position central relative to unit height
- not available for quadrant models
- Due to technical production reasons, the decor may be offset from panel to panel.



Sign

Panel options	Glass code	Supplements per unit	Supplements per unit
Sign Anti-Plaque sand-blasted decor	363	353,-	706,-

- Sand-blasted decor dimensions: height 890mm, position central relative to unit height
- not available for quadrant models
- Due to technical production reasons, the decor may be offset from panel to panel.

HÜPPE Studio Paris elegance frameless panel options

HÜPPE Studio Berlin pure frameless panel options

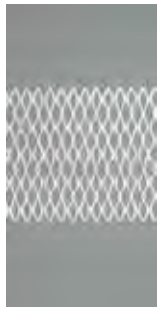

Loop

Panel options	Glass code	1 or 2 panels	3 or 4 panels
		Supplements per unit	Supplements per unit
Loop Anti-Plaquesand-blasted decor	306	353,-	706,-

- Sand-blasted decor dimensions: height 750mm, position central relative to unit height
- not available for quadrant models
- Due to technical production reasons, the decor may be offset from panel to panel.



Roses

Panel options	Glass code	Supplements per unit	Supplements per unit
		Roses Anti-Plaquesand-blasted decor	362

- Sand-blasted decor dimensions: height 810mm, position central relative to unit height
- not available for quadrant models
- Due to technical production reasons, the decor may be offset from panel to panel.



Royal

Panel options	Glass code	Supplements per unit	Supplements per unit
		Royal Anti-Plaquesand-blasted decor	365

- Sand-blasted decor dimensions: height 800mm, position central relative to unit height
- not available for quadrant models
- Due to technical production reasons, the decor may be offset from panel to panel.

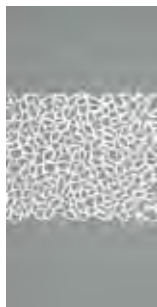

Leaves

Panel options	Glass code	Supplements per unit	Supplements per unit
		Leaves Anti-Plaquesand-blasted decor	304

- Sand-blasted decor dimensions: height 850mm, position central relative to unit height
- not available for quadrant models
- Due to technical production reasons, the decor may be offset from panel to panel.



Floral

Panel options	Glass code	Supplements per unit	Supplements per unit
		Floral Anti-Plaquesand-blasted decor	302

- Sand-blasted decor dimensions: height 800mm, width 850mm, located centrally with respect to unit width and height, 1 per front panel
- not available for quadrant models
- Due to technical production reasons, the decor may be offset from panel to panel.
- Walk-In models 1, 2, 3 and 4, floral decor only on the front panel.

HÜPPE Studio Paris elegance frameless panel options

HÜPPE Studio Berlin pure frameless panel options

Panel options	Glass code	1 or 2 panels	3 or 4 panels
		Supplements per unit	Supplements per unit
Grey Anti-Plaque	368	287,-	574,-

• not available for quadrant models



Panel options	Glass code	1 or 2 panels	3 or 4 panels
		Supplements per unit	Supplements per unit
Bronze Anti-Plaque	378	287,-	574,-

• not available for quadrant models



Panel options	Glass code	1 or 2 panels	3 or 4 panels
		Supplements per unit	Supplements per unit
Green Anti-Plaque	358	287,-	574,-

• not available for quadrant models



Panel options	Glass code	1 or 2 panels	3 or 4 panels
		Supplements per unit	Supplements per unit
Optiwhite Anti-Plaque	310	287,-	574,-

• not available for quadrant models



Panel options	Glass code	1 or 2 panels	3 or 4 panels
		Supplements per unit	Supplements per unit
Mastercarre Anti-Plaque	325	651,-	1.302,-

• not available for quadrant models



Panel options	Glass code	1 or 2 panels	3 or 4 panels
		Supplements per unit	Supplements per unit
Chinchilla Anti-Plaque	393	437,-	874,-

• not available for quadrant models

HÜPPE Studio Paris elegance frameless panel options

HÜPPE Studio Berlin pure frameless panel options

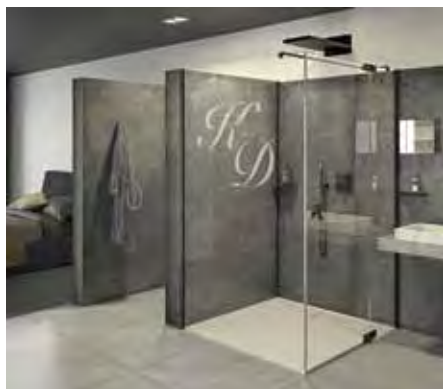

Panel options	Glass code	Supplement per panel
Individual I Anti-Plaques sand-blasted decor	359	281,-

- Initials
- Completely sand-blasted stripes

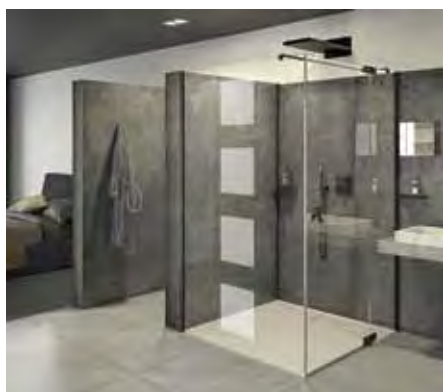

Panel options	Glass code	Supplement per panel
Individual II Anti-Plaques sand-blasted decor	360	514,-

- Simple decor, geometric shapes (stripes, squares, triangles)
- Simple logos

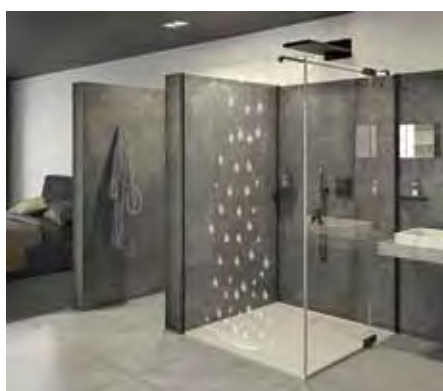

Panel options	Glass code	Supplement per panel
Custom sandblasted decor or special glass options	399	On request

- Stylish decors
- Stylish logos/crests

Extras

		Preis
	Graphical representation/digitisation of individual decors	P00050000 338,-

HÜPPE Studio Paris elegance frameless Rectangular

HÜPPE Studio Berlin pure frameless Rectangular

HÜPPE Studio Paris elegance

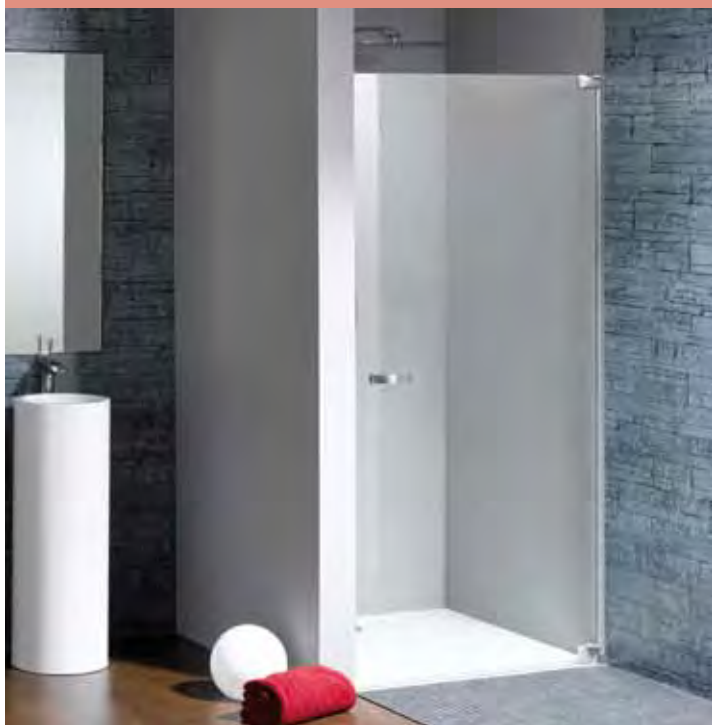

HÜPPE Studio Berlin pure

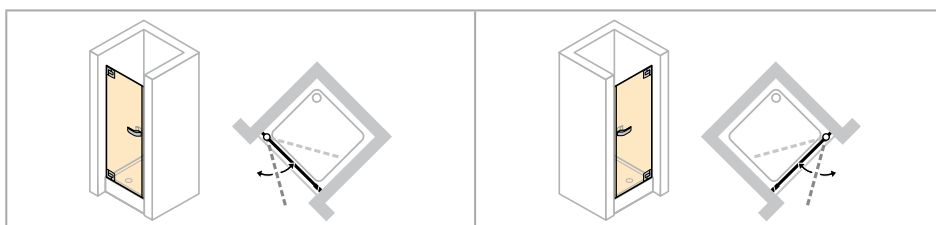
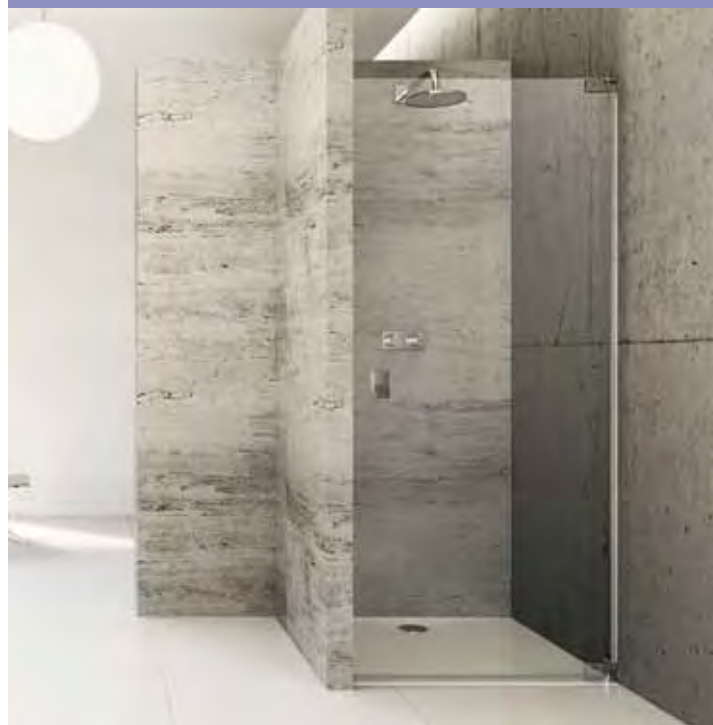

Left-hand fixing

Right-hand fixing

- Measurements must always be taken.
- Price including slopes.
- Chrome look sealing strip.
- Basic colour brilliant gold: drip deflector strip and recess profile in pearl gold.
- Individual galvanised surfaces: stainless steel look, old brass, high grade brass.

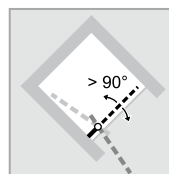
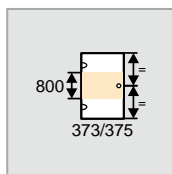
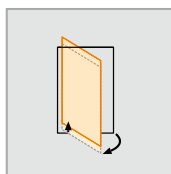
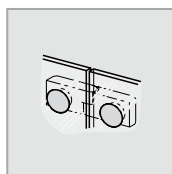
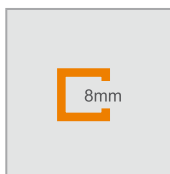

Swing door in recess

Made-to-measure - Left-hand fixing

Height	Width of door front	PARIS	BERLIN	Base price
1200-2000	500-1000	PR0009	BR0009	1.762,-
2001-2200	500-900	PR000E	BR000E	2.108,-

Filigree recess profile with magnetic closure

Made-to-measure - Right-hand fixing

Height	Width of door front	PARIS	BERLIN	Base price
1200-2000	500-1000	PR0019	BR0019	1.762,-
2001-2200	500-900	PR001E	BR001E	2.108,-

Filigree recess profile with magnetic closure

Dim. Range: min. - max.

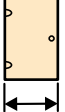
	
1200-2000	500-1000
2001-2200	500-900

Special options

Optional variants		Extra charges
Bow-shaped handle	708	151,-
without recess profile, O-profile seal on handle side	710	0,-
Bow handle, without recess profile, O-profile seal on handle side	711	151,-
Individual handle from the HÜPPE range (not in brilliant gold and individual galvanised surfaces).	704	130,-

Colours - Panel options

Basic/inlay colours	Colour code	Extra charges
Black Edition	123	171,-
Individual RAL colours	998	303,-
Individual galvanised surfaces	999	726,-

Basic colours	Colour code	Extra charges
Fittings		
High-grade matt chrome	E	0,-
Chrome	C	177,-
Brilliant gold	G	250,-

Inlay colours	Colour code	Extra charges
Brilliant gold	02	0,-
High-grade matt chrome	05	
Black	23	
White	55	
Chrome	91	

Panel options	without Anti-Plaque		with Anti-Plaque	
	Glass code	Extra charges	Glass code	Extra charges
Clear	321	0,-	322	209,-
Karo	311		312	
Sand Plus	315	186,-	316	395,-
Privatima	373		375	
Mirror glass	380	439,-	381	648,-

Further panel options - see chapter intro.

HÜPPE Studio Paris elegance frameless Rectangular

HÜPPE Studio Berlin pure frameless Rectangular

HÜPPE Studio Paris elegance

HÜPPE Studio Berlin pure

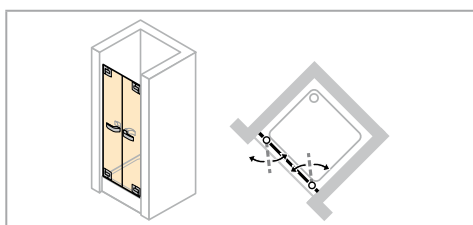
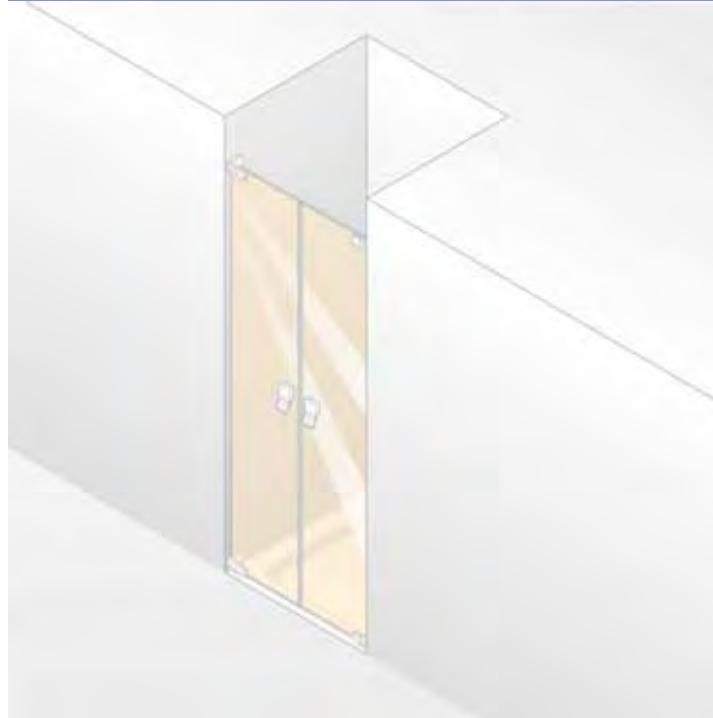

- Measurements must always be taken.
- Chrome look sealing strip.
- Basic colour brilliant gold: drip deflector strip and stylish wall profile in pearl gold.
- Individual galvanised surfaces: stainless steel look, old brass, high grade brass.
- Mirror glass (380/381): Please state in your order which segment should be produced with mirror glass. If this is not stated, the entire unit will be produced with mirror glass.
- For technical information, see Profile Colours and Panel Options section.

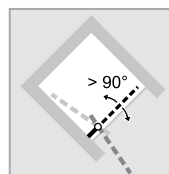
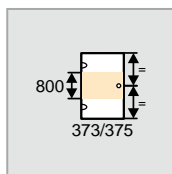
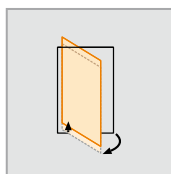
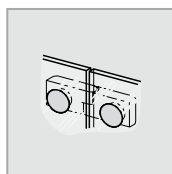
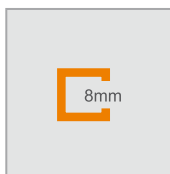

HÜPPE Studio Paris elegance frameless Rectangular



HÜPPE Studio Berlin pure frameless Rectangular

Two-way door in recess

Made-to-measure

Height	Width of door front	PARIS	BERLIN	Base price
1200-2000	600-1200	PR0069	BR0069	2.311,-
	1201-2000	PR006E	BR006E	2.704,-
2001-2200	600-1200	PR006F	BR006F	2.658,-
	1201-1800	PR006G	BR006G	3.051,-

Dim. Range: min. - max.

	
1200-2000	600-2000
2001-2200	600-1800

Special options

Optional variants		Extra charges
Bow-shaped handle	708	151,-
Individual handle from the HÜPPE range (not in brilliant gold and individual galvanised surfaces).	704	130,-

Colours - Panel options

Basic/inlay colours	Colour code	Extra charges
Black Edition	123	171,-
Individual RAL colours	998	303,-
Individual galvanised surfaces	999	726,-
Basic colours	Colour code	Extra charges
Fittings		
High-grade matt chrome	E	0,-
Chrome	C	177,-
Brilliant gold	G	250,-
Inlay colours	Colour code	Extra charges
Brilliant gold	02	0,-
High-grade matt chrome	05	
Black	23	
White	55	
Chrome	91	

Panel options	without Anti-Plaque		with Anti-Plaque	
	Glass code	Extra charges	Glass code	Extra charges
Clear	321	0,-	322	209,-
Karo	311		312	
Sand Plus	315	186,-	316	395,-
Privatima	373		375	
Mirror glass	380	439,-	381	648,-

Further panel options - see chapter intro.

HÜPPE Studio Paris elegance frameless Rectangular
HÜPPE Studio Berlin pure frameless Rectangular

HÜPPE Studio Paris elegance



HÜPPE Studio Berlin pure

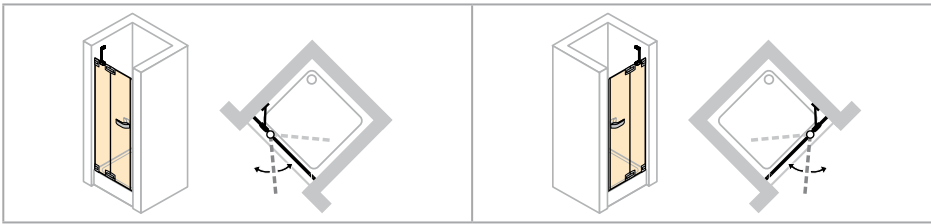

Left-hand fixing

Right-hand fixing

- Measurements must always be taken.
- Price including slopes and cut-outs.
- Chrome look sealing strip.
- Basic colour brilliant gold: drip deflector strip and recess profile in pearl gold.
- Individual galvanised surfaces: stainless steel look, old brass, high grade brass.
- Mirror glass (380/381): Please state in your order which segment should be produced with mirror glass. If this is not stated, the entire unit will be produced with mirror glass.
- For technical information, see Profile Colours and Panel Options section.

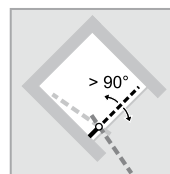
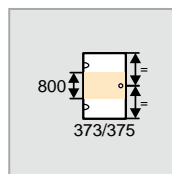
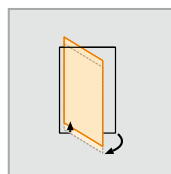
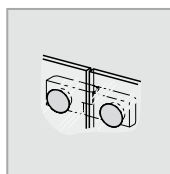
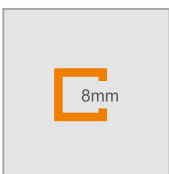

Swing door with fixed segment in recess

Made-to-measure - Left-hand fixing

Height	Width of door front	PARIS	BERLIN	Base price
1200-2000	700-1200	PR0029	BR0029	2.311,-
	1201-1500	PR002E	BR002E	2.704,-
2001-2200	700-1200	PR002F	BR002F	2.658,-
	1201-1500	PR002G	BR002G	3.051,-





Filigree recess profile with magnetic closure

Made-to-measure - Right-hand fixing

Height	Width of door front	PARIS	BERLIN	Base price
1200-2000	700-1200	PR0039	BR0039	2.311,-
	1201-1500	PR003E	BR003E	2.704,-
2001-2200	700-1200	PR003F	BR003F	2.658,-
	1201-1500	PR003G	BR003G	3.051,-

Filigree recess profile with magnetic closure

Dim. Range: min. - max.

			
1200-2200	700-1500	210-600	max. 900

Special options

Optional variants		Extra charges
Bow-shaped handle	708	151,-
without recess profile, O-profile seal on handle side	710	0,-
Bow handle, without recess profile, O-profile seal on handle side	711	151,-
Individual handle from the HÜPPE range (not in brilliant gold and individual galvanised surfaces).	704	130,-

Colours - Panel options

Basic/inlay colours	Colour code	Extra charges	Panel options		without Anti-Plaque		with Anti-Plaque	
			Glass code	Extra charges	Glass code	Extra charges		
Black Edition	123	171,-	Clear	321	0,-	322	209,-	
Individual RAL colours	998	303,-	Karo	311		312		
Individual galvanised surfaces	999	726,-	Sand Plus	315	186,-	316	395,-	
Basic colours			Privatima	373		375		
Fittings			Mirror glass	380	439,-	381	648,-	

Further panel options - see chapter intro.

Inlay colours	Colour code	Extra charges
Brilliant gold	02	0,-
High-grade matt chrome	05	
Black	23	
White	55	
Chrome	91	

HÜPPE Studio Paris elegance frameless Rectangular

HÜPPE Studio Berlin pure frameless Rectangular

HÜPPE Studio Paris elegance



HÜPPE Studio Berlin pure

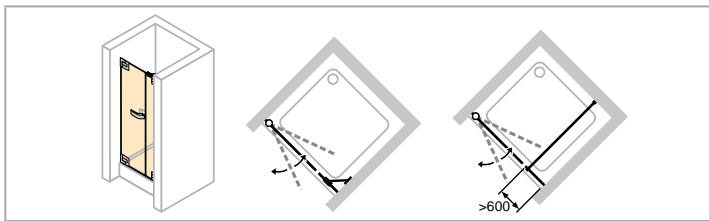
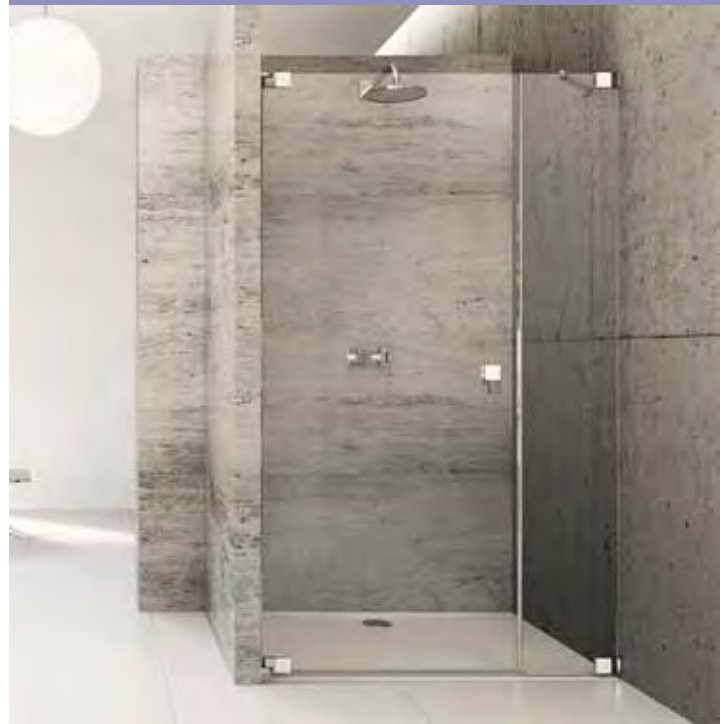

Left-hand fixing

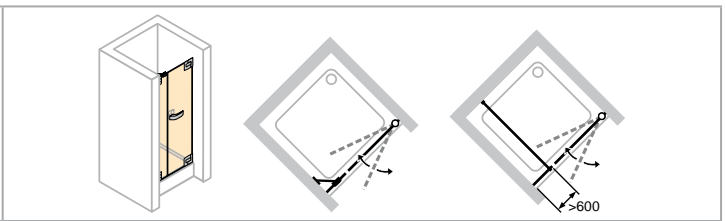

Right-hand fixing

- Measurements must always be taken.
- Price including slopes and cut-outs.
- Chrome look sealing strip.
- Individual galvanised surfaces: stainless steel look, old brass, high grade brass.
- Basic colour brilliant gold: drip deflector strip and design profile in pearl gold.
- Mirror glass (380/381): Please state in your order which segment should be produced with mirror glass. If this is not stated, the entire unit will be produced with mirror glass.
- For technical information, see Profile Colours and Panel Options section.

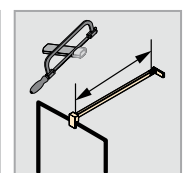
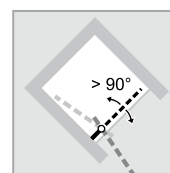
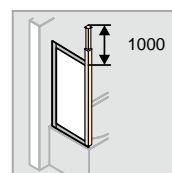
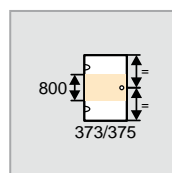
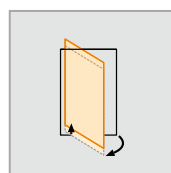
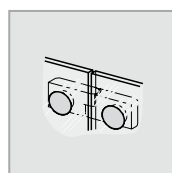
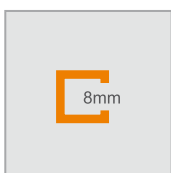

Swing door with additional section in recess





Made-to-measure - Left-hand fixing

Height	Width of door front	PARIS	BERLIN	Base price
1200-2000	700-1200	PR0049	BR0049	2.311,-
	1201-2800	PR004E	BR004E	2.704,-
2001-2200	700-1200	PR004F	BR004F	2.658,-
	1201-2700	PR004G	BR004G	3.051,-

Made-to-measure - Right-hand fixing

Height	Width of door front	PARIS	BERLIN	Base price
1200-2000	700-1200	PR0059	BR0059	2.311,-
	1201-2800	PR005E	BR005E	2.704,-
2001-2200	700-1200	PR005F	BR005F	2.658,-
	1201-2700	PR005G	BR005G	3.051,-

Dim. Range: min. - max.

			
1200-2000	700-2800	max. 1000	116-1800
2001-2200	700-2700	max. 900	116-1800

Special options

Optional variants		Extra charges
Bow-shaped handle	708	151,-
Design profile with ceiling connection. Ceiling connection min. 160mm	702	213,-
Bow-shaped handle and design profile with ceiling connection	709	364,-
Individual handle from the HÜPPE range (not in brilliant gold and individual galvanised surfaces).	704	130,-

Colours - Panel options

Basic/inlay colours	Colour code	Extra charges	Panel options		without Anti-Plaque		with Anti-Plaque	
			Glass code	Extra charges	Glass code	Extra charges		
Black Edition	123	171,-	Clear	321	0,-	322	209,-	
Individual RAL colours	998	303,-	Karo	311		312		
Individual galvanised surfaces	999	726,-	Sand Plus	315	186,-	316	395,-	
Privatima			373		375			
Mirror glass			380	439,-	381	648,-		

Further panel options - see chapter intro.

Basic colours	Colour code	Extra charges
Fittings		
High-grade matt chrome	E	0,-
Chrome	C	177,-
Brilliant gold	G	250,-

Inlay colours	Colour code	Extra charges
Brilliant gold	02	0,-
High-grade matt chrome	05	
Black	23	
White	55	
Chrome	91	

HÜPPE Studio Paris elegance frameless Rectangular

HÜPPE Studio Berlin pure frameless Rectangular

HÜPPE Studio Paris elegance

HÜPPE Studio Berlin pure

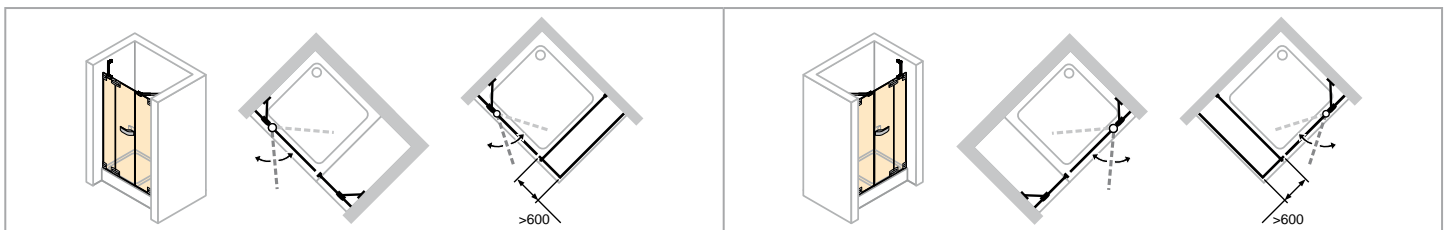
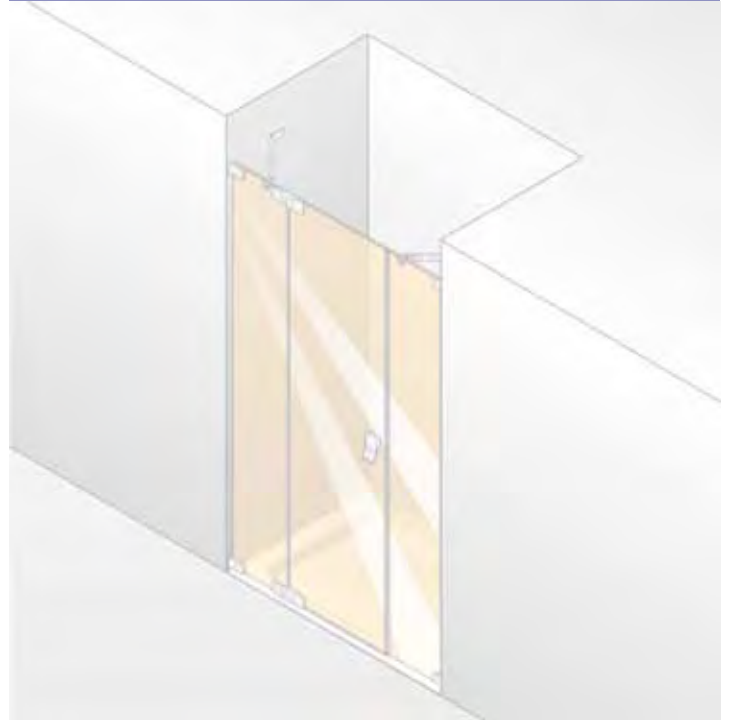
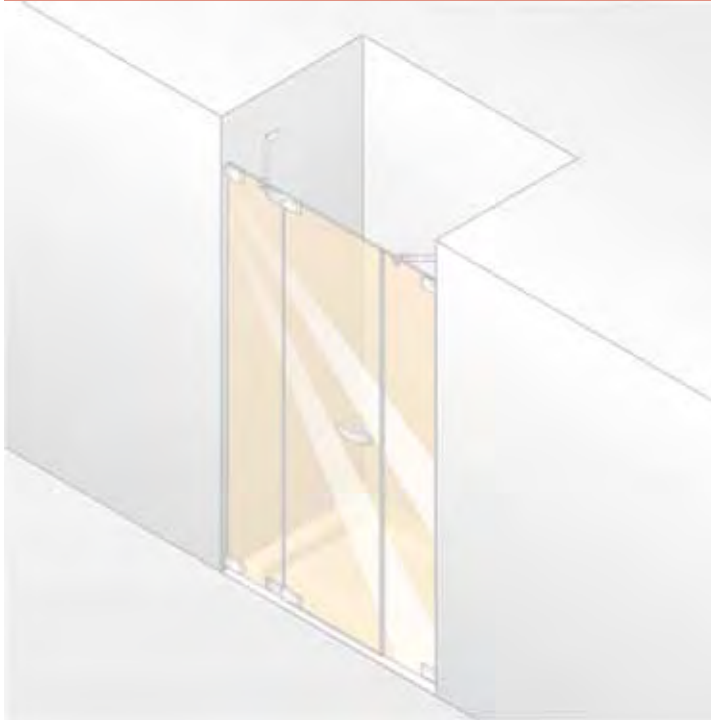

Left-hand fixing

Right-hand fixing

- Measurements must always be taken.
- Price including slopes and cut-outs.
- Chrome look sealing strip.
- Basic colour brilliant gold: drip deflector strip and design profile in pearl gold.
- Individual galvanised surfaces: stainless steel look, old brass, high grade brass.
- Mirror glass (380/381): Please state in your order which segment should be produced with mirror glass. If this is not stated, the entire unit will be produced with mirror glass.
- For technical information, see Profile Colours and Panel Options section.

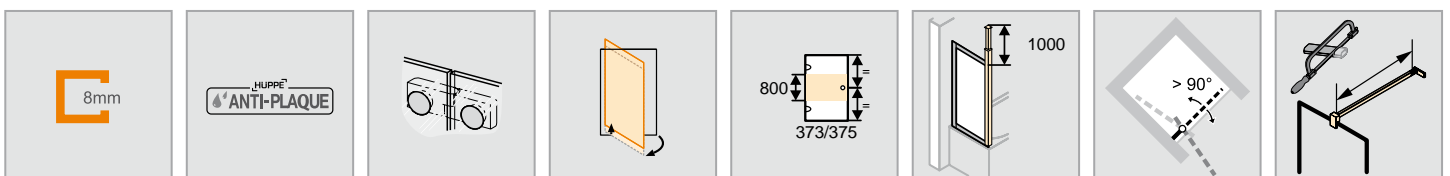

HÜPPE Studio Paris elegance frameless Rectangular HÜPPE Studio Berlin pure frameless Rectangular

Swing door with fixed segment and additional section in recess

Made-to-measure - Left-hand fixing

Height	Width of door front	PARIS	BERLIN	Base price
1200-2000	1000-1500	PR0089	BR0089	3.115,-
	1501-3300	PR008E	BR008E	3.508,-
2001-2200	1000-1500	PR008F	BR008F	3.460,-
	1501-3300	PR008G	BR008G	3.854,-

Made-to-measure - Right-hand fixing

Height	Width of door front	PARIS	BERLIN	Base price
1200-2000	1000-1500	PR0099	BR0099	3.115,-
	1501-3300	PR009E	BR009E	3.508,-
2001-2200	1000-1500	PR009F	BR009F	3.460,-
	1501-3300	PR009G	BR009G	3.854,-

Dim. Range: min. - max.

1200-2200	1000-3300	210-600	max. 900	116-1800

Special options

Optional variants		Extra charges
Bow-shaped handle	708	151,-
Design profile with ceiling connection. Ceiling connection min. 160mm	702	213,-
Bow-shaped handle and design profile with ceiling connection	709	364,-
Individual handle from the HÜPPE range (not in brilliant gold and individual galvanised surfaces).	704	130,-

Colours - Panel options

Basic/inlay colours	Colour code	Extra charges
Black Edition	123	342,-
Individual RAL colours	998	606,-
Individual galvanised surfaces	999	1.452,-

Basic colours	Colour code	Extra charges
Fittings		
High-grade matt chrome	E	0,-
Chrome	C	354,-
Brilliant gold	G	500,-

Inlay colours	Colour code	Extra charges
Brilliant gold	02	0,-
High-grade matt chrome	05	
Black	23	
White	55	
Chrome	91	

Panel options	without Anti-Plaque		with Anti-Plaque	
	Glass code	Extra charges	Glass code	Extra charges
Clear	321	0,-	322	418,-
Karo	311		312	
Sand Plus	315	371,-	316	789,-
Privatima	373		375	
Mirror glass	380	439,-	381	857,-

Further panel options - see chapter intro.

HÜPPE Studio Paris elegance frameless Rectangular

HÜPPE Studio Berlin pure frameless Rectangular

HÜPPE Studio Paris elegance



HÜPPE Studio Berlin pure

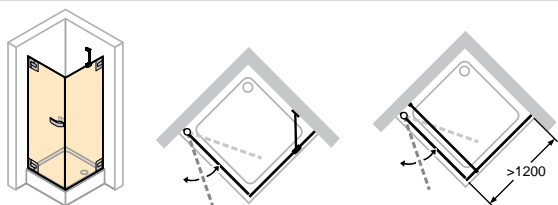

Left-hand fixing

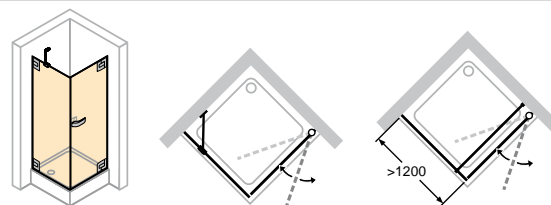

Right-hand fixing

- Measurements must always be taken.
- Price including slopes and cut-outs.
- Chrome look sealing strip.
- Basic colour brilliant gold: drip deflector strip and design profile in pearl gold.
- Individual galvanised surfaces: stainless steel look, old brass, high grade brass.
- Mirror glass (380/381): Please state in your order which segment should be produced with mirror glass. If this is not stated, the entire unit will be produced with mirror glass.
- For technical information, see Profile Colours and Panel Options section.
- Towel rail height can be selected individually and must be specified with the order. If nothing is specified, the towel rail is always delivered middle of glass (height and width).
- Installation of towel rail only possible on side panel.

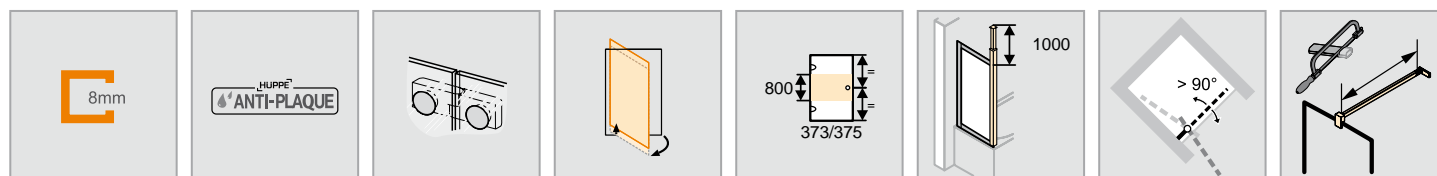

Swing door with side panel

Made-to-measure - Left-hand fixing

Height	Door width	Width Side panel	PARIS	BERLIN	Base price
1200-2000	500-1000	300-1200	PR0109	BR0109	2.693,-
	500-1000	1201-1800	PR010E	BR010E	3.086,-
2001-2200	500-900	300-1200	PR010F	BR010F	3.385,-
	500-900	1201-1800	PR010G	BR010G	3.778,-

Made-to-measure - Right-hand fixing

Height	Door width	Width Side panel	PARIS	BERLIN	Base price
1200-2000	500-1000	300-1200	PR0119	BR0119	2.693,-
	500-1000	1201-1800	PR011E	BR011E	3.086,-
2001-2200	500-900	300-1200	PR011F	BR011F	3.385,-
	500-900	1201-1800	PR011G	BR011G	3.778,-

Dim. Range: min. - max.

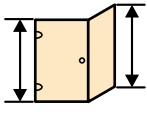
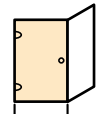
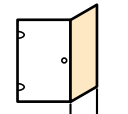
		
1200-2000	500-1000	300-1800
2001-2200	500-900	300-1800

Special options

Optional variants		Extra charges
Bow-shaped handle	708	151,-
Design profile with ceiling connection. Ceiling connection min. 160mm	702	213,-
Bow-shaped handle and design profile with ceiling connection	709	364,-
Individual handle from the HÜPPE range (not in brilliant gold and individual galvanised surfaces).	704	130,-
Towel rail (high-gloss silver as standard, towel rail in black for Black Edition systems)	T99	210,-
Towel rail and bow-shaped handle	T08	361,-
Towel rail and ceiling connection. Ceiling connection min. 160mm.	T02	423,-
Towel rail, bow-shaped handle and ceiling connection. Ceiling connection min. 160mm.	T09	574,-
Towel rail and individual handle from the HÜPPE range (not in brilliant gold and individual galvanised surfaces)	T04	340,-

Colours - Panel options

Basic/inlay colours	Colour code	Extra charges
Black Edition	123	342,-
Individual RAL colours	998	606,-
Individual galvanised surfaces	999	1.452,-

Basic colours	Colour code	Extra charges
Fittings		
High-grade matt chrome	E	0,-
Chrome	C	354,-
Brilliant gold	G	500,-

Inlay colours	Colour code	Extra charges
Brilliant gold	02	0,-
High-grade matt chrome	05	
Black	23	
White	55	
Chrome	91	

Panel options	without Anti-Plaque		with Anti-Plaque	
	Glass code	Extra charges	Glass code	Extra charges
Clear	321	0,-	322	418,-
Karo	311		312	
Sand Plus	315	371,-	316	789,-
Privatima	373		375	
Mirror glass	380	439,-	381	857,-

Further panel options - see chapter intro.

HÜPPE Studio Paris elegance frameless Rectangular

HÜPPE Studio Berlin pure frameless Rectangular

HÜPPE Studio Paris elegance



HÜPPE Studio Berlin pure

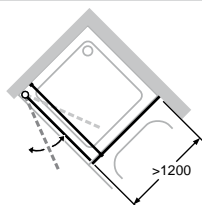
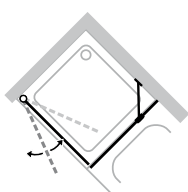
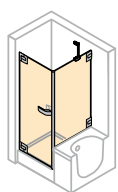

Left-hand fixing

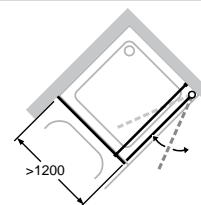
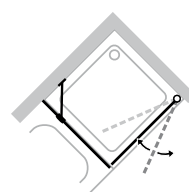
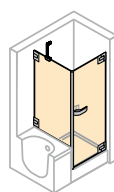

Right-hand fixing

- Measurements must always be taken.
- Price including slopes and cut-outs.
- Chrome look sealing strip.
- Basic colour brilliant gold: drip deflector strip and recess profile in pearl gold.
- Individual galvanised surfaces: stainless steel look, old brass, high grade brass.
- Mirror glass (380/381): Please state in your order which segment should be produced with mirror glass. If this is not stated, the entire unit will be produced with mirror glass.
- For technical information, see Profile Colours and Panel Options section.
- Towel rail height can be selected individually and must be specified with the order. If nothing is specified, the towel rail is always delivered middle of glass (height and width).
- Installation of towel rail only possible on side panel.

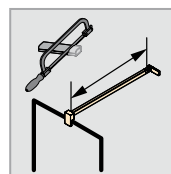
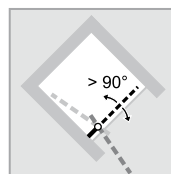
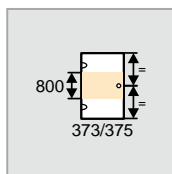
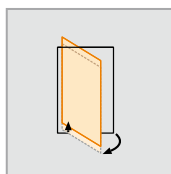
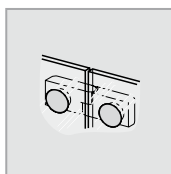
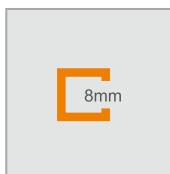

HÜPPE Studio Paris elegance frameless Rectangular HÜPPE Studio Berlin pure frameless Rectangular

Swing door with short side panel on bathtub

Made-to-measure - Left-hand fixing

Height	Door width	Width Side panel	PARIS	BERLIN	Base price
1200-2000	500-1000	300-1200	PR0209	BR0209	2.693,-
	500-1000	1201-1800	PR020E	BR020E	3.086,-
2001-2200	500-900	300-1200	PR020F	BR020F	3.385,-
	500-900	1201-1800	PR020G	BR020G	3.778,-

Made-to-measure - Right-hand fixing

Height	Door width	Width Side panel	PARIS	BERLIN	Base price
1200-2000	500-1000	300-1200	PR0219	BR0219	2.693,-
	500-1000	1201-1800	PR021E	BR021E	3.086,-
2001-2200	500-900	300-1200	PR021F	BR021F	3.385,-
	500-900	1201-1800	PR021G	BR021G	3.778,-

Dim. Range: min. - max.

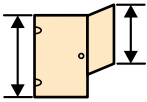
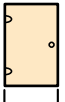
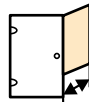
		
1200-2000	500-1000	300-1800
2001-2200	500-900	300-1800

Special options

Optional variants		Extra charges
Bow-shaped handle	708	151,-
Individual handle from the HÜPPE range (not in brilliant gold and individual galvanised surfaces).	704	130,-
Towel rail (high-gloss silver as standard, towel rail in black for Black Edition systems)	T99	210,-
Towel rail and bow-shaped handle	T08	361,-
Towel rail and individual handle from the HÜPPE range (not in brilliant gold and individual galvanised surfaces)	T04	340,-

Colours - Panel options

Basic/inlay colours	Colour code	Extra charges	Panel options		without Anti-Plaque		with Anti-Plaque	
			Glass code	Extra charges	Glass code	Extra charges		
Black Edition	123	342,-	321	0,-	322	418,-		
Individual RAL colours	998	606,-	311		312			
Individual galvanised surfaces	999	1.452,-	315	371,-	316	789,-		
Basic colours	Colour code	Extra charges	373		375			
Fittings	Colour code	Extra charges	380	439,-	381	857,-		
High-grade matt chrome	E	0,-						
Chrome	C	354,-						
Brilliant gold	G	500,-						

Further panel options - see chapter intro.

Inlay colours	Colour code	Extra charges
Brilliant gold	02	0,-
High-grade matt chrome	05	
Black	23	
White	55	
Chrome	91	

HÜPPE Studio Paris elegance frameless Rectangular

HÜPPE Studio Berlin pure frameless Rectangular

HÜPPE Studio Paris elegance



HÜPPE Studio Berlin pure

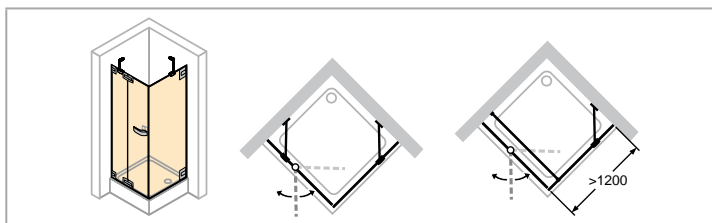

Left-hand fixing

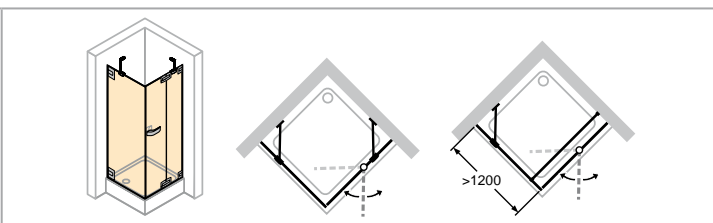

Right-hand fixing

- Measurements must always be taken.
- Price including slopes and cut-outs.
- Chrome look sealing strip.
- Basic colour brilliant gold: drip deflector strip and design profile in pearl gold.
- Individual galvanised surfaces: stainless steel look, old brass, high grade brass.
- Mirror glass (380/381): Please state in your order which segment should be produced with mirror glass. If this is not stated, the entire unit will be produced with mirror glass.
- For technical information, see Profile Colours and Panel Options section.
- Towel rail height can be selected individually and must be specified with the order. If nothing is specified, the towel rail is always delivered middle of glass (height and width).
- Installation of towel rail only possible on side panel.

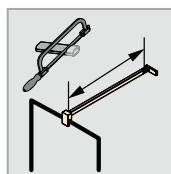
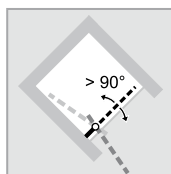
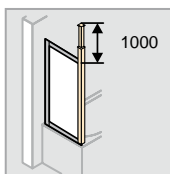
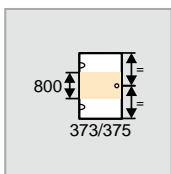
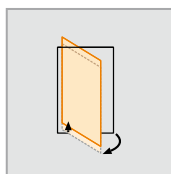
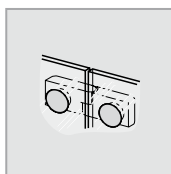
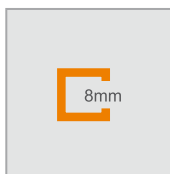

Swing door with fixed segment and side panel

Made-to-measure - Left-hand fixing

Height	Door width	Width Side panel	PARIS	BERLIN	Base price
1200-2000	700-1200	300-1200	PR0129	BR0129	3.115,-
	700-1200	1201-1800	PR012E	BR012E	3.508,-
	1201-1500	300-1200			
2001-2200	1201-1500	1201-1800	PR012F	BR012F	3.901,-
	700-1200	300-1200	PR012G	BR012G	3.807,-
	700-1200	1201-1800	PR012H	BR012H	4.199,-
	1201-1500	300-1200			
	1201-1500	1201-1800	PR012J	BR012J	4.593,-

Made-to-measure - Right-hand fixing

Height	Door width	Width Side panel	PARIS	BERLIN	Base price
1200-2000	700-1200	300-1200	PR0139	BR0139	3.115,-
	700-1200	1201-1800	PR013E	BR013E	3.508,-
	1201-1500	300-1200			
2001-2200	1201-1500	1201-1800	PR013F	BR013F	3.901,-
	700-1200	300-1200	PR013G	BR013G	3.807,-
	700-1200	1201-1800	PR013H	BR013H	4.199,-
	1201-1500	300-1200			
	1201-1500	1201-1800	PR013J	BR013J	4.593,-

Dim. Range: min. - max.

1200-2200	700-1500	210-600	max. 900	300-1800

Special options

Optional variants		Extra charges
Bow-shaped handle	708	151,-
Design profile with ceiling connection. Ceiling connection min. 160mm	702	213,-
Bow-shaped handle and design profile with ceiling connection	709	364,-
Individual handle from the HÜPPE range (not in brilliant gold and individual galvanised surfaces).	704	130,-
Towel rail (high-gloss silver as standard, towel rail in black for Black Edition systems)	T99	210,-
Towel rail and bow-shaped handle	T08	361,-
Towel rail and ceiling connection. Ceiling connection min. 160mm.	T02	423,-
Towel rail, bow-shaped handle and ceiling connection. Ceiling connection min. 160mm.	T09	574,-
Towel rail and individual handle from the HÜPPE range (not in brilliant gold and individual galvanised surfaces)	T04	340,-

Colours - Panel options

Basic/inlay colours	Colour code	Extra charges	Panel options		without Anti-Plaque		with Anti-Plaque	
			Glass code	Extra charges	Glass code	Extra charges		
Black Edition	123	342,-	Clear	321	0,-	322	418,-	
Individual RAL colours	998	606,-	Karo	311		312		
Individual galvanised surfaces	999	1.452,-	Sand Plus	315	371,-	316	789,-	
Basic colours			Privatima	373		375		
Fittings			Mirror glass	380	439,-	381	857,-	
High-grade matt chrome	E	0,-	Further panel options - see chapter intro.					
Chrome	C	354,-						
Brilliant gold	G	500,-						
Inlay colours								
Brilliant gold	02	0,-						
High-grade matt chrome	05							
Black	23							
White	55							
Chrome	91							

HÜPPE Studio Paris elegance frameless Rectangular
HÜPPE Studio Berlin pure frameless Rectangular

HÜPPE Studio Paris elegance

HÜPPE Studio Berlin pure

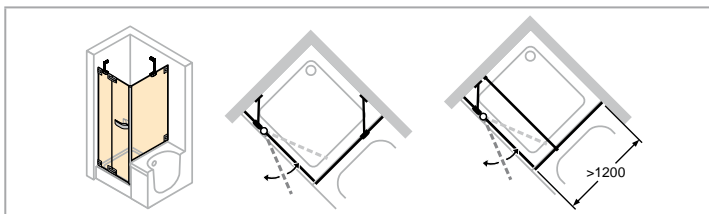
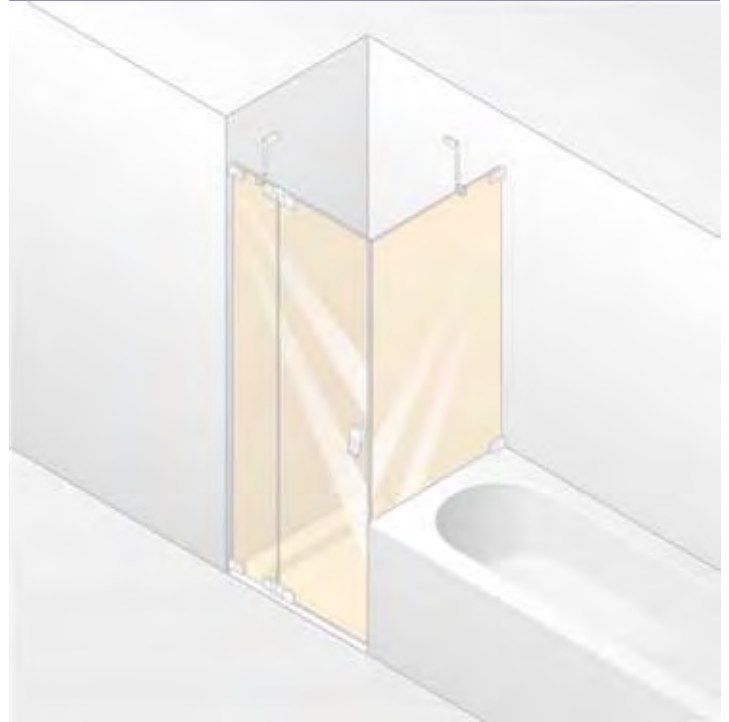
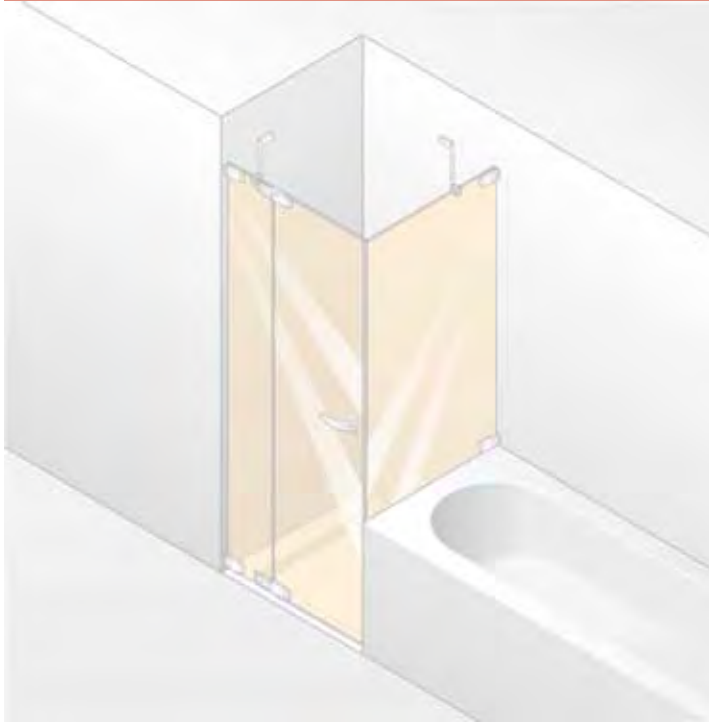

Left-hand fixing

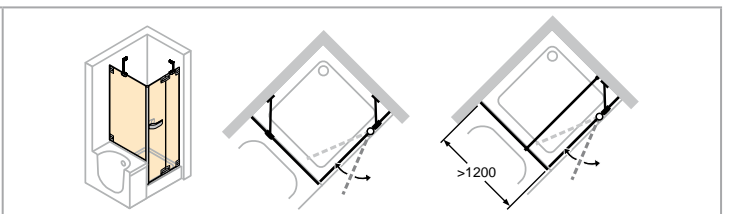

Right-hand fixing

- Measurements must always be taken.
- Price including slopes and cut-outs.
- Chrome look sealing strip.
- Basic colour brilliant gold: drip deflector strip and recess profile in pearl gold.
- Individual galvanised surfaces: stainless steel look, old brass, high grade brass.
- Mirror glass (380/381): Please state in your order which segment should be produced with mirror glass. If this is not stated, the entire unit will be produced with mirror glass.
- For technical information, see Profile Colours and Panel Options section.
- Towel rail height can be selected individually and must be specified with the order. If nothing is specified, the towel rail is always delivered middle of glass (height and width).
- Installation of towel rail only possible on side panel.

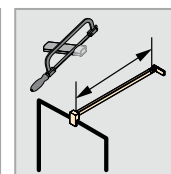
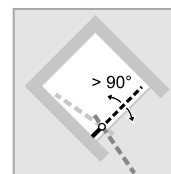
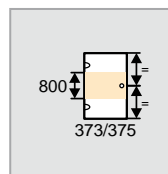
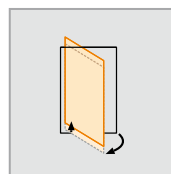
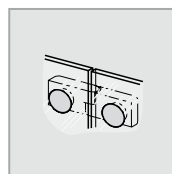
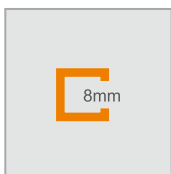

HÜPPE Studio Paris elegance frameless Rectangular HÜPPE Studio Berlin pure frameless Rectangular

Swing door with fixed segment and shortened side panel on bathtub

Made-to-measure - Left-hand fixing

Height	Door width	Width Side panel	PARIS	BERLIN	Base price
1200-2000	700-1200	300-1200	PR0229	BR0229	3.115,-
	700-1200	1201-1800	PR022E	BR022E	3.508,-
	1201-1500	300-1200			
2001-2200	1201-1500	1201-1800	PR022F	BR022F	3.901,-
	700-1200	300-1200	PR022G	BR022G	3.807,-
	700-1200	1201-1800	PR022H	BR022H	4.199,-
	1201-1500	300-1200			
	1201-1500	1201-1800	PR022J	BR022J	4.593,-

Made-to-measure - Right-hand fixing

Height	Door width	Width Side panel	PARIS	BERLIN	Base price
1200-2000	700-1200	300-1200	PR0239	BR0239	3.115,-
	700-1200	1201-1800	PR023E	BR023E	3.508,-
	1201-1500	300-1200			
2001-2200	1201-1500	1201-1800	PR023F	BR023F	3.901,-
	700-1200	300-1200	PR023G	BR023G	3.807,-
	700-1200	1201-1800	PR023H	BR023H	4.199,-
	1201-1500	300-1200			
	1201-1500	1201-1800	PR023J	BR023J	4.593,-

Dim. Range: min. - max.

1200-2200	700-1500	210-600	max. 900	300-1800

Special options

Optional variants		Extra charges
Bow-shaped handle	708	151,-
Individual handle from the HÜPPE range (not in brilliant gold and individual galvanised surfaces).	704	130,-
Towel rail (high-gloss silver as standard, towel rail in black for Black Edition systems)	T99	210,-
Towel rail and bow-shaped handle	T08	361,-
Towel rail and individual handle from the HÜPPE range (not in brilliant gold and individual galvanised surfaces)	T04	340,-

Colours - Panel options

Basic/inlay colours	Colour code	Extra charges
Black Edition	123	342,-
Individual RAL colours	998	606,-
Individual galvanised surfaces	999	1.452,-
Basic colours	Colour code	Extra charges
Fittings		
High-grade matt chrome	E	0,-
Chrome	C	354,-
Brilliant gold	G	500,-
Inlay colours	Colour code	Extra charges
Brilliant gold	02	0,-
High-grade matt chrome	05	
Black	23	
White	55	
Chrome	91	

Panel options	without Anti-Plaque		with Anti-Plaque	
	Glass code	Extra charges	Glass code	Extra charges
Clear	321	0,-	322	418,-
Karo	311	371,-	312	789,-
Sand Plus	315		316	
Privatima	373	439,-	375	857,-
Mirror glass	380		381	

Further panel options - see chapter intro.

HÜPPE Studio Paris elegance frameless Rectangular

HÜPPE Studio Berlin pure frameless Rectangular

HÜPPE Studio Paris elegance

HÜPPE Studio Berlin pure

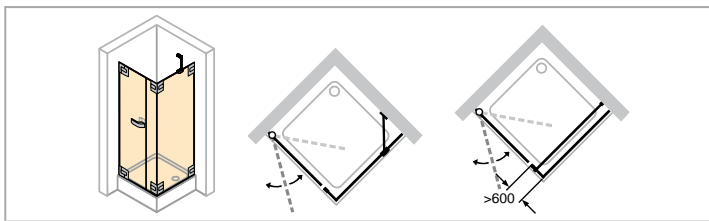
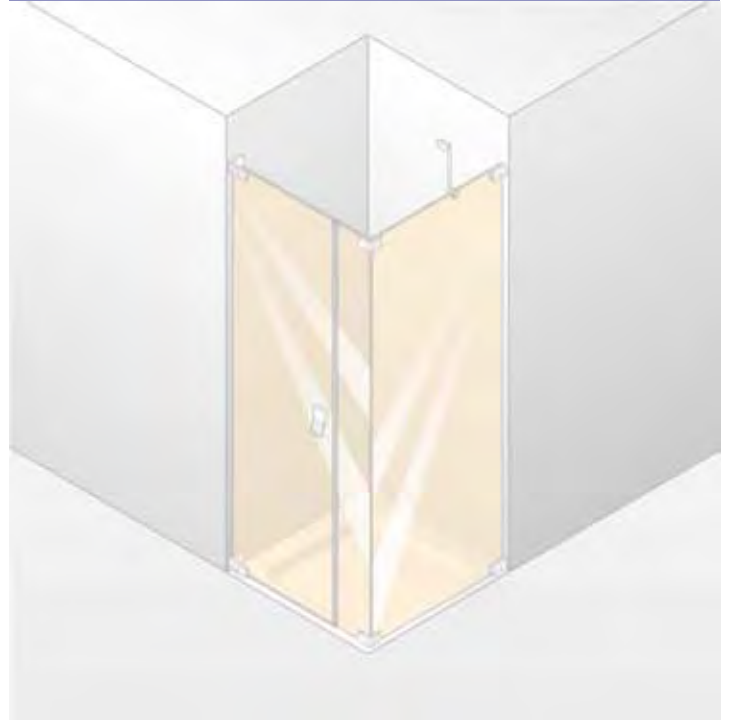
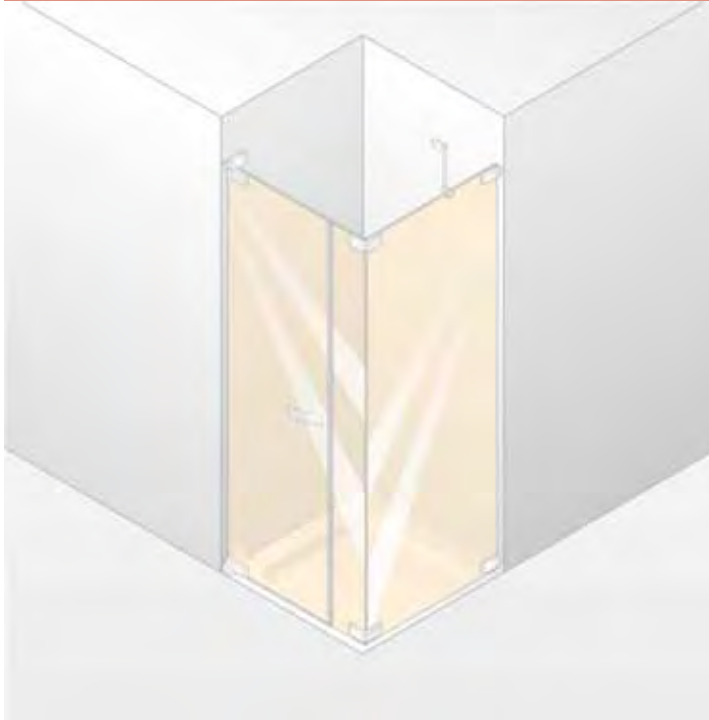

Left-hand fixing

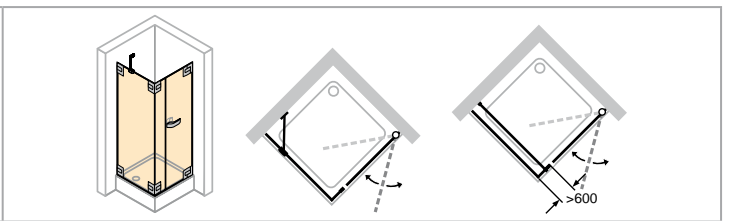

Right-hand fixing

- Measurements must always be taken.
- Price including slopes and cut-outs.
- Chrome look sealing strip.
- Basic colour brilliant gold: drip deflector strip and design profile in pearl gold.
- Individual galvanised surfaces: stainless steel look, old brass, high grade brass.
- Mirror glass (380/381): Please state in your order which segment should be produced with mirror glass. If this is not stated, the entire unit will be produced with mirror glass.
- For technical information, see Profile Colours and Panel Options section.
- Towel rail height can be selected individually and must be specified with the order. If nothing is specified, the towel rail is always delivered middle of glass (height and width).
- Installation of towel rail only possible on side panel.

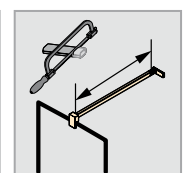
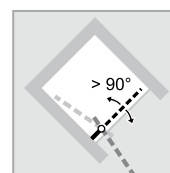
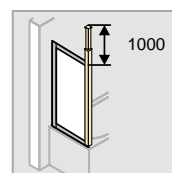
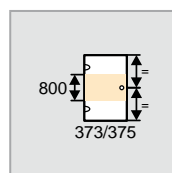
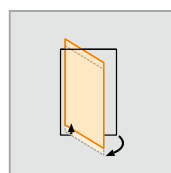
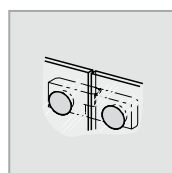
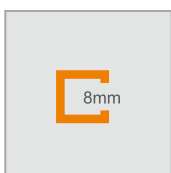

HÜPPE Studio Paris elegance frameless Rectangular HÜPPE Studio Berlin pure frameless Rectangular

Swing door with additional section and side panel

Made-to-measure - Left-hand fixing

Height	Door width	Width Side panel	PARIS	BERLIN	Base price
1200-2000	700-1200	300-1200	PR0149	BR0149	3.115,-
	700-1200	1201-1800	PR014E	BR014E	3.508,-
	1201-2800	300-1200			
2001-2200	1201-2800	1201-1800	PR014F	BR014F	3.901,-
	700-1200	300-1200	PR014G	BR014G	3.807,-
	700-1200	1201-1800	PR014H	BR014H	4.199,-
	1201-2700	300-1200			
	1201-2700	1201-1800	PR014J	BR014J	4.593,-

Made-to-measure - Right-hand fixing

Height	Door width	Width Side panel	PARIS	BERLIN	Base price
1200-2000	700-1200	300-1200	PR0159	BR0159	3.115,-
	700-1200	1201-1800	PR015E	BR015E	3.508,-
	1201-2800	300-1200			
2001-2200	1201-2800	1201-1800	PR015F	BR015F	3.901,-
	700-1200	300-1200	PR015G	BR015G	3.807,-
	700-1200	1201-1800	PR015H	BR015H	4.199,-
	1201-2700	300-1200			
	1201-2700	1201-1800	PR015J	BR015J	4.593,-

Dim. Range: min. - max.

1200-2000	700-2800	max. 1000	116-1800	300-1800
2001-2200	700-2700	max. 900	116-1800	300-1800

Special options

Optional variants		Extra charges
Bow-shaped handle	708	151,-
Design profile with ceiling connection. Ceiling connection min. 160mm	702	213,-
Bow-shaped handle and design profile with ceiling connection	709	364,-
Individual handle from the HÜPPE range (not in brilliant gold and individual galvanised surfaces).	704	130,-
Towel rail (high-gloss silver as standard, towel rail in black for Black Edition systems)	T99	210,-
Towel rail and bow-shaped handle	T08	361,-
Towel rail and ceiling connection. Ceiling connection min. 160mm.	T02	423,-
Towel rail, bow-shaped handle and ceiling connection. Ceiling connection min. 160mm.	T09	574,-
Towel rail and individual handle from the HÜPPE range (not in brilliant gold and individual galvanised surfaces)	T04	340,-

Colours - Panel options

Basic/inlay colours	Colour code	Extra charges	Panel options		without Anti-Plaque		with Anti-Plaque	
			Glass code	Extra charges	Glass code	Extra charges		
Black Edition	123	342,-	Clear	0,-	321	322	418,-	
Individual RAL colours	998	606,-	Karo		311	312		
Individual galvanised surfaces	999	1.452,-	Sand Plus	371,-	315	316	789,-	
Basic colours			Privatima		373	375		
Fittings			Mirror glass	439,-	380	381	857,-	
High-grade matt chrome	E	0,-	Further panel options - see chapter intro.					
Chrome	C	354,-						
Brilliant gold	G	500,-						
Inlay colours								
Brilliant gold	02	0,-						
High-grade matt chrome	05							
Black	23							
White	55							
Chrome	91							

HÜPPE Studio Paris elegance frameless Rectangular

HÜPPE Studio Berlin pure frameless Rectangular

HÜPPE Studio Paris elegance

HÜPPE Studio Berlin pure

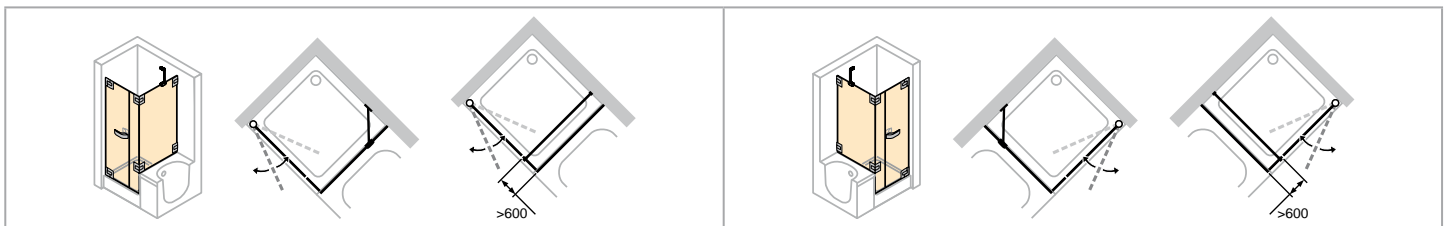
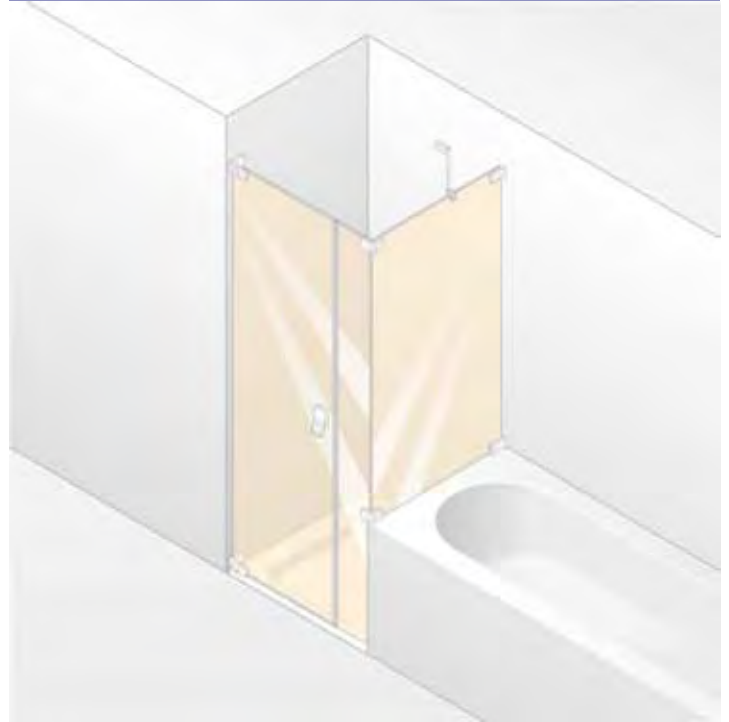
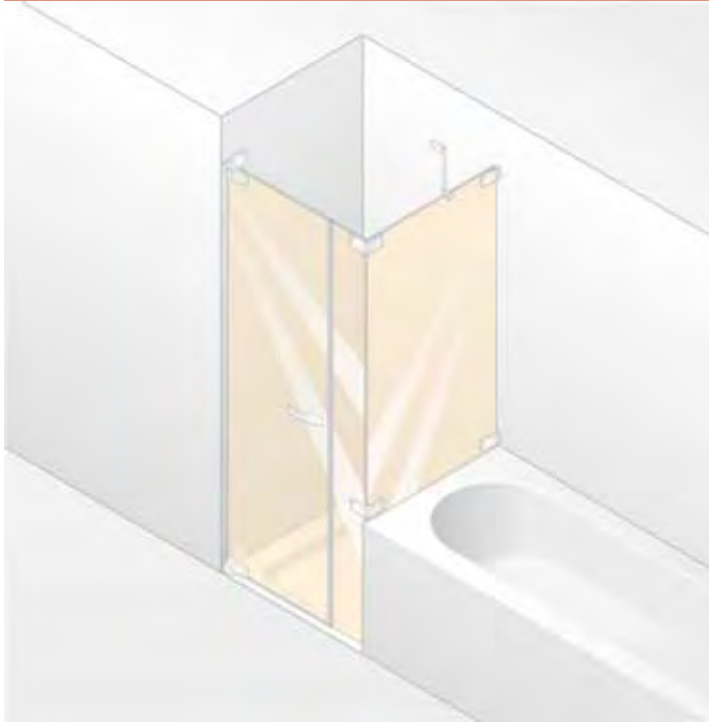

Left-hand fixing

Right-hand fixing

- Measurements must always be taken.
- Price including slopes and cut-outs.
- Chrome look sealing strip.
- Basic colour brilliant gold: drip deflector strip and design profile in pearl gold.
- Individual galvanised surfaces: stainless steel look, old brass, high grade brass.
- Mirror glass (380/381): Please state in your order which segment should be produced with mirror glass. If this is not stated, the entire unit will be produced with mirror glass.
- For technical information, see Profile Colours and Panel Options section.
- Towel rail height can be selected individually and must be specified with the order. If nothing is specified, the towel rail is always delivered middle of glass (height and width).
- Installation of towel rail only possible on side panel.

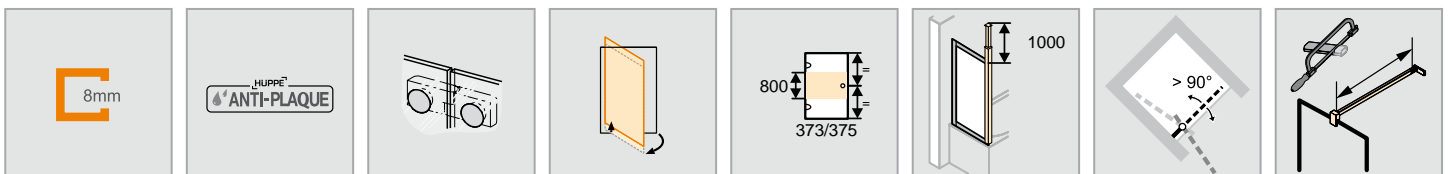

HÜPPE Studio Paris elegance frameless Rectangular HÜPPE Studio Berlin pure frameless Rectangular

Swing door with additional section and shortened side panel on bathtub

Made-to-measure - Left-hand fixing

Height	Door width	Width Side panel	PARIS	BERLIN	Base price
1200-2000	700-1200	300-1200	PR0249	BR0249	3.115,-
	700-1200	1201-1800	PR024E	BR024E	3.508,-
	1201-2800	300-1200			
2001-2200	1201-2800	1201-1800	PR024F	BR024F	3.901,-
	700-1200	300-1200	PR024G	BR024G	3.807,-
	700-1200	1201-1800	PR024H	BR024H	4.199,-
	1201-2700	300-1200			
	1201-2700	1201-1800	PR024J	BR024J	4.593,-

Made-to-measure - Right-hand fixing

Height	Door width	Width Side panel	PARIS	BERLIN	Base price
1200-2000	700-1200	300-1200	PR0259	BR0259	3.115,-
	700-1200	1201-1800	PR025E	BR025E	3.508,-
	1201-2800	300-1200			
2001-2200	1201-2800	1201-1800	PR025F	BR025F	3.901,-
	700-1200	300-1200	PR025G	BR025G	3.807,-
	700-1200	1201-1800	PR025H	BR025H	4.199,-
	1201-2700	300-1200			
	1201-2700	1201-1800	PR025J	BR025J	4.593,-

Dim. Range: min. - max.

1200-2000	700-2800	max. 1000	116-1800	300-1800
2001-2200	700-2700	max. 900	116-1800	300-1800

Special options

Optional variants		Extra charges
Bow-shaped handle	708	151,-
Design profile with ceiling connection. Ceiling connection min. 160mm	702	213,-
Bow-shaped handle and design profile with ceiling connection	709	364,-
Individual handle from the HÜPPE range (not in brilliant gold and individual galvanised surfaces).	704	130,-
Towel rail (high-gloss silver as standard, towel rail in black for Black Edition systems)	T99	210,-
Towel rail and bow-shaped handle	T08	361,-
Towel rail and ceiling connection. Ceiling connection min. 160mm.	T02	423,-
Towel rail, bow-shaped handle and ceiling connection. Ceiling connection min. 160mm.	T09	574,-
Towel rail and individual handle from the HÜPPE range (not in brilliant gold and individual galvanised surfaces)	T04	340,-

Colours - Panel options

Basic/inlay colours	Colour code	Extra charges	Panel options		without Anti-Plaque		with Anti-Plaque	
			Glass code	Extra charges	Glass code	Extra charges		
Black Edition	123	342,-	Clear	0,-	321	322	418,-	
Individual RAL colours	998	606,-	Karo		311	312		
Individual galvanised surfaces	999	1.452,-	Sand Plus	371,-	315	316	789,-	
Basic colours			Privatima		373	375		
Fittings			Mirror glass	439,-	380	381	857,-	
High-grade matt chrome	E	0,-	Further panel options - see chapter intro.					
Chrome	C	354,-						
Brilliant gold	G	500,-						
Inlay colours	Colour code	Extra charges						
Brilliant gold	02	0,-						
High-grade matt chrome	05							
Black	23							
White	55							
Chrome	91							

HÜPPE Studio Paris elegance frameless Rectangular

HÜPPE Studio Berlin pure frameless Rectangular

HÜPPE Studio Paris elegance



HÜPPE Studio Berlin pure

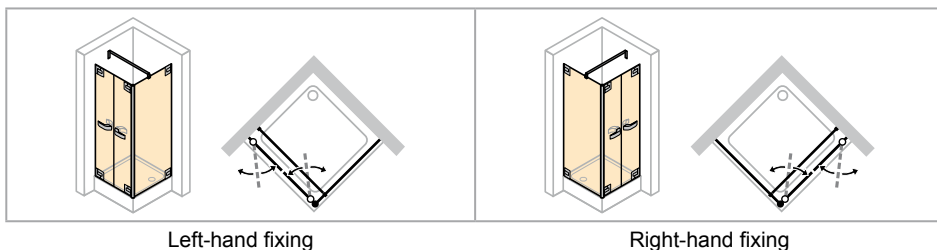

Left-hand fixing

Right-hand fixing

- Measurements must always be taken.
- Price including slopes and cut-outs.
- Chrome look sealing strip.
- Basic colour brilliant gold: drip deflector strip and design profile in pearl gold.
- Individual galvanised surfaces: stainless steel look, old brass, high grade brass.
- Always with design profile.
- Mirror glass (380/381): Please state in your order which segment should be produced with mirror glass. If this is not stated, the entire unit will be produced with mirror glass.
- For technical information, see Profile Colours and Panel Options section.
- Towel rail height can be selected individually and must be specified with the order. If nothing is specified, the towel rail is always delivered middle of glass (height and width).
- Installation of towel rail only possible on side panel.

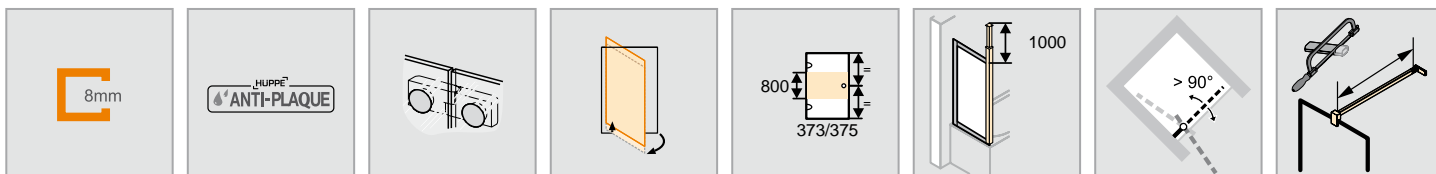

Two-way door with side panel

Made-to-measure - Left-hand fixing

Height	Door width	Width Side panel	PARIS	BERLIN	Base price
1200-2000	600-1200	300-1200	PR0169	BR0169	3.115,-
	600-1200	1201-1800	PR016E	BR016E	3.508,-
2001-2200	600-1200	300-1200	PR016F	BR016F	3.807,-
	600-1200	1201-1800	PR016G	BR016G	4.199,-

Made-to-measure - Right-hand fixing

Height	Door width	Width Side panel	PARIS	BERLIN	Base price
1200-2000	600-1200	300-1200	PR0179	BR0179	3.115,-
	600-1200	1201-1800	PR017E	BR017E	3.508,-
2001-2200	600-1200	300-1200	PR017F	BR017F	3.807,-
	600-1200	1201-1800	PR017G	BR017G	4.199,-

Dim. Range: min. - max.

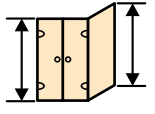
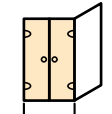
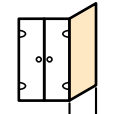
		
1200-2200	600-1200	300-1800

Special options

Optional variants		Extra charges
Bow-shaped handle	708	151,-
Design profile with ceiling connection. Ceiling connection min. 160mm	702	213,-
Bow-shaped handle and design profile with ceiling connection	709	364,-
Individual handle from the HÜPPE range (not in brilliant gold and individual galvanised surfaces).	704	130,-
Towel rail (high-gloss silver as standard, towel rail in black for Black Edition systems)	T99	210,-
Towel rail and bow-shaped handle	T08	361,-
Towel rail and ceiling connection. Ceiling connection min. 160mm.	T02	423,-
Towel rail, bow-shaped handle and ceiling connection. Ceiling connection min. 160mm.	T09	574,-
Towel rail and individual handle from the HÜPPE range (not in brilliant gold and individual galvanised surfaces)	T04	340,-

Colours - Panel options

Basic/inlay colours	Colour code	Extra charges
Black Edition	123	342,-
Individual RAL colours	998	606,-
Individual galvanised surfaces	999	1.452,-
Basic colours	Colour code	Extra charges
Fittings		
High-grade matt chrome	E	0,-
Chrome	C	354,-
Brilliant gold	G	500,-
Inlay colours	Colour code	Extra charges
Brilliant gold	02	0,-
High-grade matt chrome	05	
Black	23	
White	55	
Chrome	91	

Panel options	without Anti-Plaque		with Anti-Plaque	
	Glass code	Extra charges	Glass code	Extra charges
Clear	321	0,-	322	418,-
Karo	311		312	
Sand Plus	315	371,-	316	789,-
Privatima	373		375	
Mirror glass	380	439,-	381	857,-

Further panel options - see chapter intro.

HÜPPE Studio Paris elegance frameless Rectangular

HÜPPE Studio Berlin pure frameless Rectangular

HÜPPE Studio Paris elegance

HÜPPE Studio Berlin pure

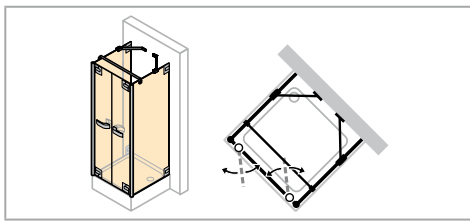
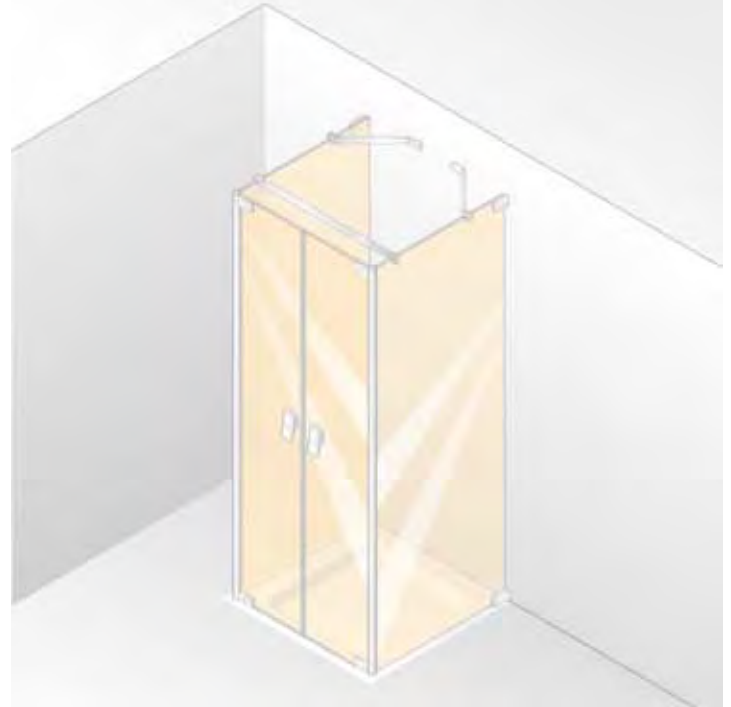
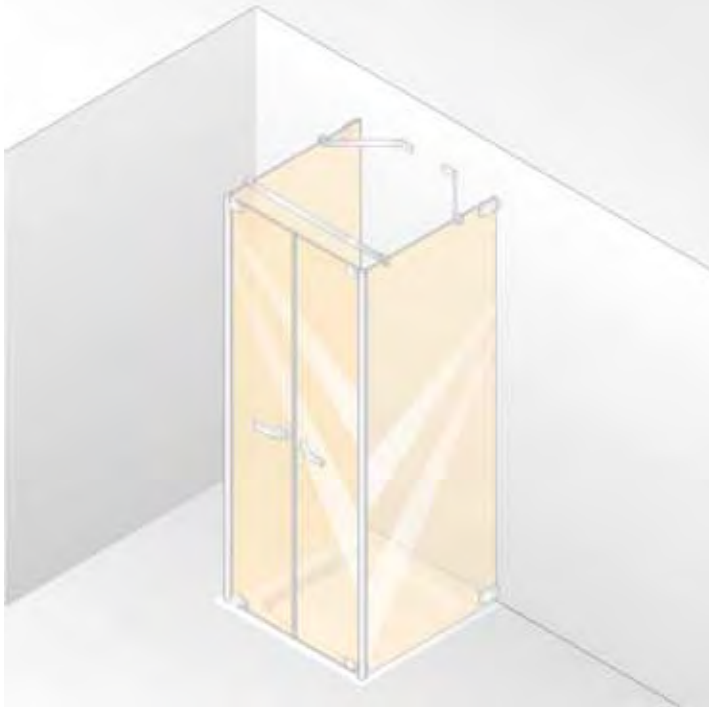

- Measurements must always be taken.
- Price including slopes and cut-outs.
- Chrome look sealing strip.
- Basic colour brilliant gold: drip deflector strip and design profile in pearl gold.
- Individual galvanised surfaces: stainless steel look, old brass, high grade brass.
- Always with design profile.
- Mirror glass (380/381): Please state in your order which segment should be produced with mirror glass. If this is not stated, the entire unit will be produced with mirror glass.
- For technical information, see Profile Colours and Panel Options section.
- Towel rail height can be selected individually and must be specified with the order. If nothing is specified, the towel rail is always delivered middle of glass (height and width).
- Installation of towel rail only possible on side panel.

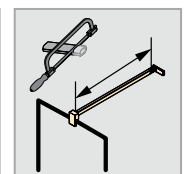
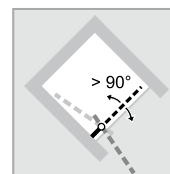
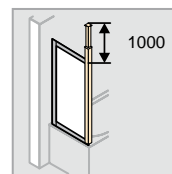
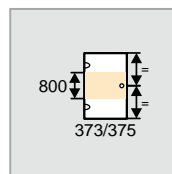
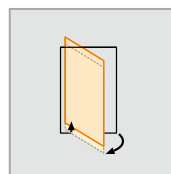
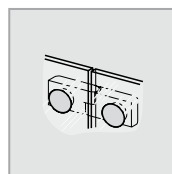
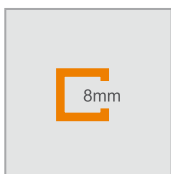

Two-way door with two side panels as U-shaped enclosure

Made-to-measure

Height	Door width	Width Side panel	PARIS	BERLIN	Base price
1200-2000	600-1200	300-1200	PR0669	BR0669	4.380,-
	600-1200	1201-1500	PR066E	BR066E	4.773,-
2001-2200	600-1200	300-1200	PR066F	BR066F	5.073,-
	600-1200	1201-1500	PR066G	BR066G	5.466,-

Dim. Range: min. - max.

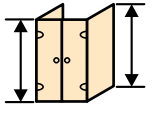
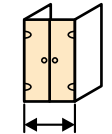
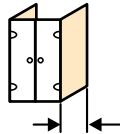
		
1200-2200	600-1200	300-1500

Special options

Optional variants		Extra charges
Bow-shaped handle	708	151,-
Design profile with ceiling connection. Ceiling connection min. 160mm	702	213,-
Bow-shaped handle and design profile with ceiling connection	709	364,-
Individual handle from the HÜPPE range (not in brilliant gold and individual galvanised surfaces).	704	130,-
Towel rail (high-gloss silver as standard, towel rail in black for Black Edition systems)	T99	210,-
Towel rail and bow-shaped handle	T08	361,-
Towel rail and ceiling connection. Ceiling connection min. 160mm.	T02	423,-
Towel rail, bow-shaped handle and ceiling connection. Ceiling connection min. 160mm.	T09	574,-
Towel rail and individual handle from the HÜPPE range (not in brilliant gold and individual galvanised surfaces)	T04	340,-

Colours - Panel options

Basic/inlay colours	Colour code	Extra charges	Panel options		without Anti-Plaque		with Anti-Plaque	
			Glass code	Extra charges	Glass code	Extra charges		
Black Edition	123	342,-	Clear	321	0,-	322	418,-	
Individual RAL colours	998	606,-	Karo	311		312		
Individual galvanised surfaces	999	1.452,-	Sand Plus	315	371,-	316	789,-	
Basic colours	Colour code	Extra charges	Privatima	373		375		
Fittings			Mirror glass	380	439,-	381	857,-	

Further panel options - see chapter intro.

Inlay colours	Colour code	Extra charges
Brilliant gold	02	0,-
High-grade matt chrome	05	
Black	23	
White	55	
Chrome	91	

HÜPPE Studio Paris elegance frameless Rectangular
HÜPPE Studio Berlin pure frameless Rectangular

HÜPPE Studio Paris elegance

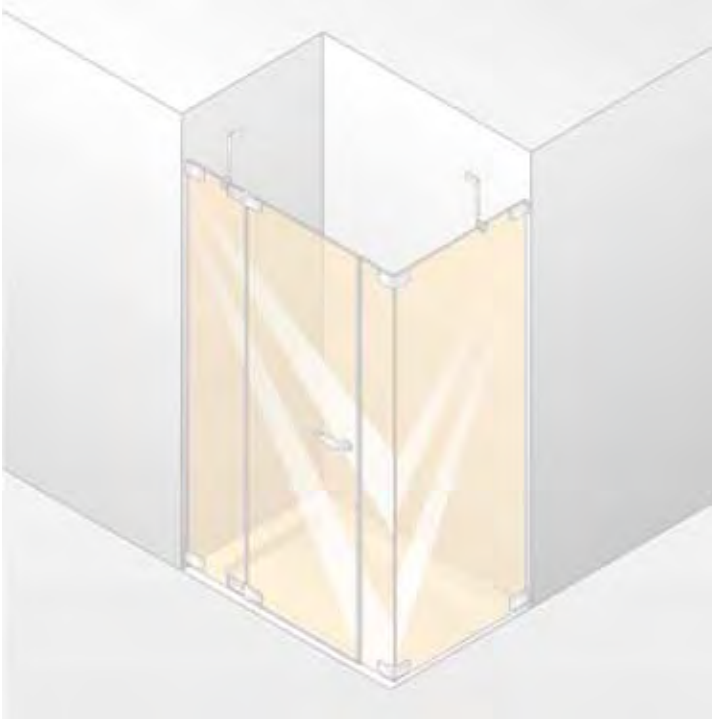

HÜPPE Studio Berlin pure

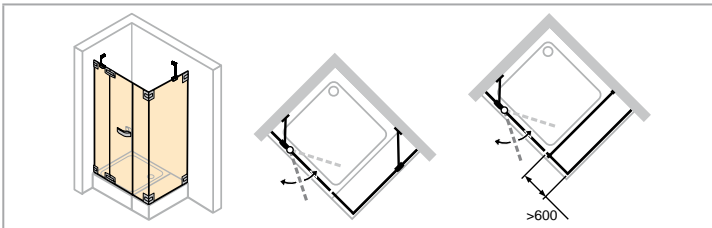
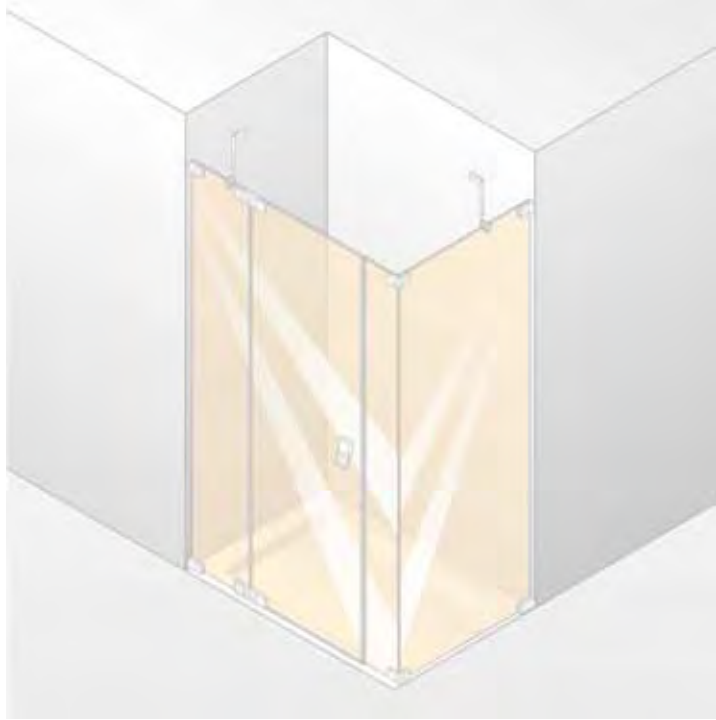

Left-hand fixing

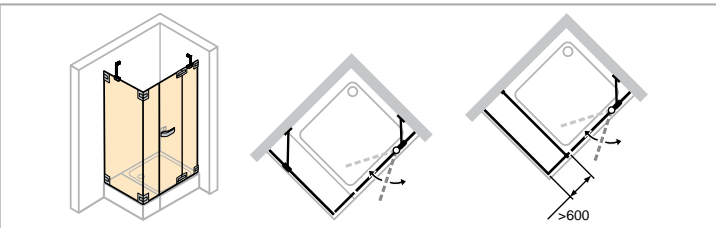

Right-hand fixing

- Measurements must always be taken.
- Price including slopes and cut-outs.
- Chrome look sealing strip.
- Basic colour brilliant gold: drip deflector strip and design profile in pearl gold.
- Individual galvanised surfaces: stainless steel look, old brass, high grade brass.
- Mirror glass (380/381): Please state in your order which segment should be produced with mirror glass. If this is not stated, the entire unit will be produced with mirror glass.
- For technical information, see Profile Colours and Panel Options section.
- Towel rail height can be selected individually and must be specified with the order. If nothing is specified, the towel rail is always delivered middle of glass (height and width).
- Installation of towel rail only possible on side panel.

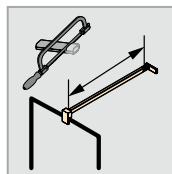
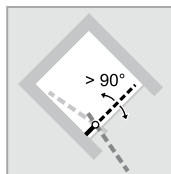
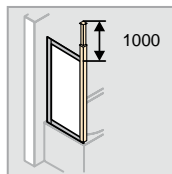
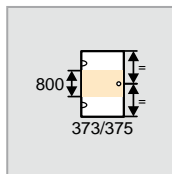
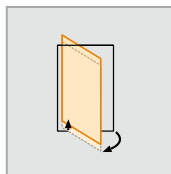
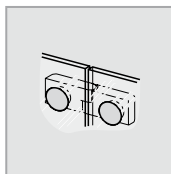
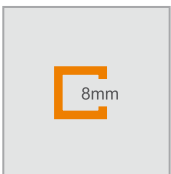

HÜPPE Studio Paris elegance frameless Rectangular HÜPPE Studio Berlin pure frameless Rectangular

Swing door with fixed segment, with additional section and side panel

Made-to-measure - Left-hand fixing

Height	Door width	Width Side panel	PARIS	BERLIN	Base price
1200-2000	900-1200	300-1200	PR0189	BR0189	3.537,-
	900-1200	1201-1800	PR018E	BR018E	3.931,-
	1201-3300	300-1200			
2001-2200	1201-3300	1201-1800	PR018F	BR018F	4.324,-
	900-1200	300-1200	PR018G	BR018G	4.230,-
	900-1200	1201-1800	PR018H	BR018H	4.624,-
	1201-3300	300-1200			
	1201-3300	1201-1800	PR018J	BR018J	5.017,-

Made-to-measure - Right-hand fixing

Height	Door width	Width Side panel	PARIS	BERLIN	Base price
1200-2000	900-1200	300-1200	PR0199	BR0199	3.537,-
	900-1200	1201-1800	PR019E	BR019E	3.931,-
	1201-3300	300-1200			
2001-2200	1201-3300	1201-1800	PR019F	BR019F	4.324,-
	900-1200	300-1200	PR019G	BR019G	4.230,-
	900-1200	1201-1800	PR019H	BR019H	4.624,-
	1201-3300	300-1200			
	1201-3300	1201-1800	PR019J	BR019J	5.017,-

Dim. Range: min. - max.

1200-2200	900-3300	210-600	max. 900	116-1800	300-1800

Special options

Optional variants		Extra charges
Bow-shaped handle	708	151,-
Design profile with ceiling connection. Ceiling connection min. 160mm	702	213,-
Bow-shaped handle and design profile with ceiling connection	709	364,-
Individual handle from the HÜPPE range (not in brilliant gold and individual galvanised surfaces).	704	130,-
Towel rail (high-gloss silver as standard, towel rail in black for Black Edition systems)	T99	210,-
Towel rail and bow-shaped handle	T08	361,-
Towel rail and ceiling connection. Ceiling connection min. 160mm.	T02	423,-
Towel rail, bow-shaped handle and ceiling connection. Ceiling connection min. 160mm.	T09	574,-
Towel rail and individual handle from the HÜPPE range (not in brilliant gold and individual galvanised surfaces)	T04	340,-

Colours - Panel options

Basic/inlay colours	Colour code	Extra charges	Panel options		without Anti-Plaque		with Anti-Plaque			
			Glass code	Extra charges	Glass code	Extra charges				
Black Edition	123	342,-	Clear	321	0,-	322	418,-			
Individual RAL colours	998	606,-	Karo	311	371,-	312	789,-			
Individual galvanised surfaces	999	1.452,-	Sand Plus	315		316				
Basic colours	Colour code	Extra charges	Privatima	373	375	Mirror glass	380	439,-	381	857,-
Fittings			Further panel options - see chapter intro.							
High-grade matt chrome	E	0,-								
Chrome	C	354,-								
Brilliant gold	G	500,-								
Inlay colours	Colour code	Extra charges								
Brilliant gold	02	0,-								
High-grade matt chrome	05									
Black	23									
White	55									
Chrome	91									

HÜPPE Studio Paris elegance frameless Rectangular

HÜPPE Studio Berlin pure frameless Rectangular

HÜPPE Studio Paris elegance

HÜPPE Studio Berlin pure

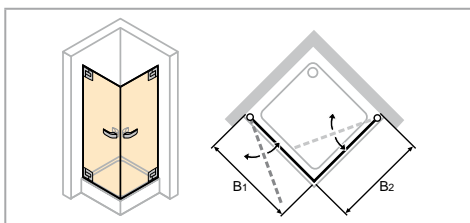

- Measurements must always be taken.
- Price including slopes and cut-outs.
- Chrome look sealing strip.
- Basic colour brilliant gold: drip deflector strip and stylish wall profile in pearl gold.
- Individual galvanised surfaces: stainless steel look, old brass, high grade brass.
- Mirror glass (380/381): Please state in your order which segment should be produced with mirror glass. If this is not stated, the entire unit will be produced with mirror glass.
- For technical information, see Profile Colours and Panel Options section.

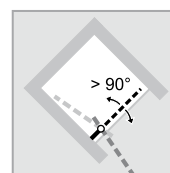
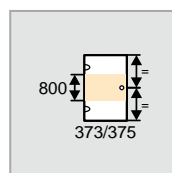
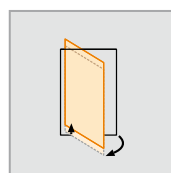
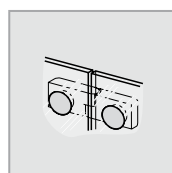
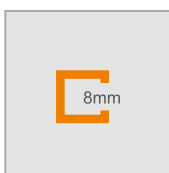

Swing door corner entry

Made-to-measure

Height	Width B1	Width B2	PARIS	BERLIN	Base price
1200-2000	500-1000	500-1000	PR0309	BR0309	2.693,-
2001-2200	500-900	500-900	PR030E	BR030E	3.385,-

Dim. Range: min. - max.

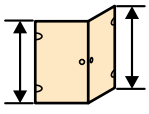
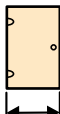
	
1200-2000	500-1000
2001-2200	500-900

Special options

Optional variants		Extra charges
Bow-shaped handle	708	151,-
Individual handle from the HÜPPE range (not in brilliant gold and individual galvanised surfaces).	704	130,-

Colours - Panel options

Basic/inlay colours	Colour code	Extra charges	Panel options	without Anti-Plaque		with Anti-Plaque	
				Glass code	Extra charges	Glass code	Extra charges
Black Edition	123	342,-	Clear	321	0,-	322	418,-
Individual RAL colours	998	606,-	Karo	311		312	
Individual galvanised surfaces	999	1.452,-	Sand Plus	315	371,-	316	789,-
Basic colours	Colour code	Extra charges	Privatima	373		375	
Fittings			Mirror glass	380	439,-	381	857,-
High-grade matt chrome	E	0,-	Further panel options - see chapter intro.				
Chrome	C	354,-					
Brilliant gold	G	500,-					
Inlay colours	Colour code	Extra charges					
Brilliant gold	02	0,-					
High-grade matt chrome	05						
Black	23						
White	55						
Chrome	91						

HÜPPE Studio Paris elegance frameless Rectangular

HÜPPE Studio Berlin pure frameless Rectangular

HÜPPE Studio Paris elegance



HÜPPE Studio Berlin pure

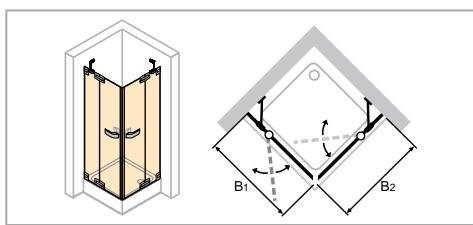

- Measurements must always be taken.
- Price including slopes and cut-outs.
- Chrome look sealing strip.
- Basic colour brilliant gold: drip deflector strip in pearl gold.
- Individual galvanised surfaces: stainless steel look, old brass, high grade brass.
- Mirror glass (380/381): Please state in your order which segment should be produced with mirror glass. If this is not stated, the entire unit will be produced with mirror glass.
- For technical information, see Profile Colours and Panel Options section.

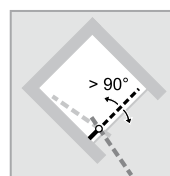
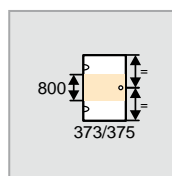
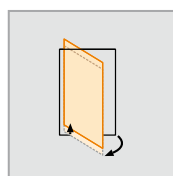
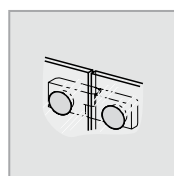
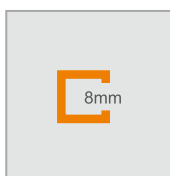

HÜPPE Studio Paris elegance frameless Rectangular HÜPPE Studio Berlin pure frameless Rectangular

Swing door corner entry with fixed segments

Made-to-measure

Height	Width B1	Width B2	PARIS	BERLIN	Base price
1200-2000	700-1200	700-1200	PR0329	BR0329	3.537,-
	1201-1500	1201-1500	PR032E	BR032E	3.931,-
2001-2200	700-1200	700-1200	PR032F	BR032F	4.230,-
	1201-1500	1201-1500	PR032G	BR032G	4.624,-

Dim. Range: min. - max.

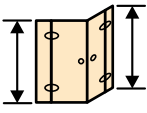
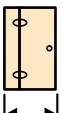
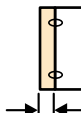
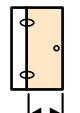
			
1200-2200	700-1500	210-600	max. 900

Special options

Optional variants		Extra charges
Bow-shaped handle	708	151,-
Individual handle from the HÜPPE range (not in brilliant gold and individual galvanised surfaces).	704	130,-

Colours - Panel options

Basic/inlay colours	Colour code	Extra charges
Black Edition	123	342,-
Individual RAL colours	998	606,-
Individual galvanised surfaces	999	1.452,-

Basic colours	Colour code	Extra charges
Fittings		
High-grade matt chrome	E	0,-
Chrome	C	354,-
Brilliant gold	G	500,-

Inlay colours	Colour code	Extra charges
Brilliant gold	02	0,-
High-grade matt chrome	05	
Black	23	
White	55	
Chrome	91	

Panel options	without Anti-Plaque		with Anti-Plaque	
	Glass code	Extra charges	Glass code	Extra charges
Clear	321	0,-	322	418,-
Karo	311		312	
Sand Plus	315	371,-	316	789,-
Privatima	373		375	
Mirror glass	380	439,-	381	857,-

Further panel options - see chapter intro.

HÜPPE Studio Paris elegance frameless Quadrant
HÜPPE Studio Berlin pure frameless Quadrant

HÜPPE Studio Paris elegance



HÜPPE Studio Berlin pure

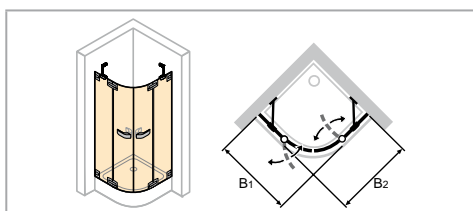

- Measurements must always be taken.
- Price including slopes and cut-outs.
- Chrome look sealing strip.
- Basic colour brilliant gold: drip deflector strip in pearl gold.
- Individual galvanised surfaces: stainless steel look, old brass, high grade brass.

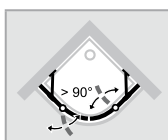
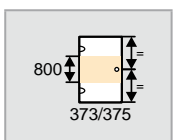
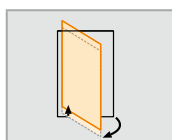
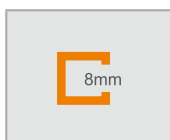



Swing door with fixed segments, 2-panel

Made-to-measure

Height	Width B1	Width B2	Radius	PARIS	BERLIN	Base price
2000	900-1200	900-1200	500	PR2009	BR2009	3.537,-
	900-1200	900-1200	550	PR2209	BR2209	

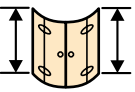
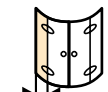
Dim. Range: min. - max.

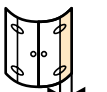
				
2000	210-600	900-1200	900-1200	210-600

Colours - Panel options

Basic/inlay colours	Colour code	Extra charges
Black Edition	123	342,-
Individual RAL colours	998	606,-
Individual galvanised surfaces	999	1.452,-
Basic colours	Colour code	Extra charges
Fittings		
High-grade matt chrome	E	0,-
Chrome	C	354,-
Brilliant gold	G	500,-
Inlay colours	Colour code	Extra charges
Brilliant gold	02	0,-
High-grade matt chrome	05	
Black	23	
White	55	
Chrome	91	

Panel options	without Anti-Plaque		with Anti-Plaque	
	Glass code	Extra charges	Glass code	Extra charges
Clear	321	0,-	322	418,-
Karo	311	371,-	312	789,-
Sand Plus	315		316	
Privatima	373		375	

Further panel options - see chapter intro.

HÜPPE Studio Paris elegance frameless Quadrant
HÜPPE Studio Berlin pure frameless Quadrant

HÜPPE Studio Paris elegance

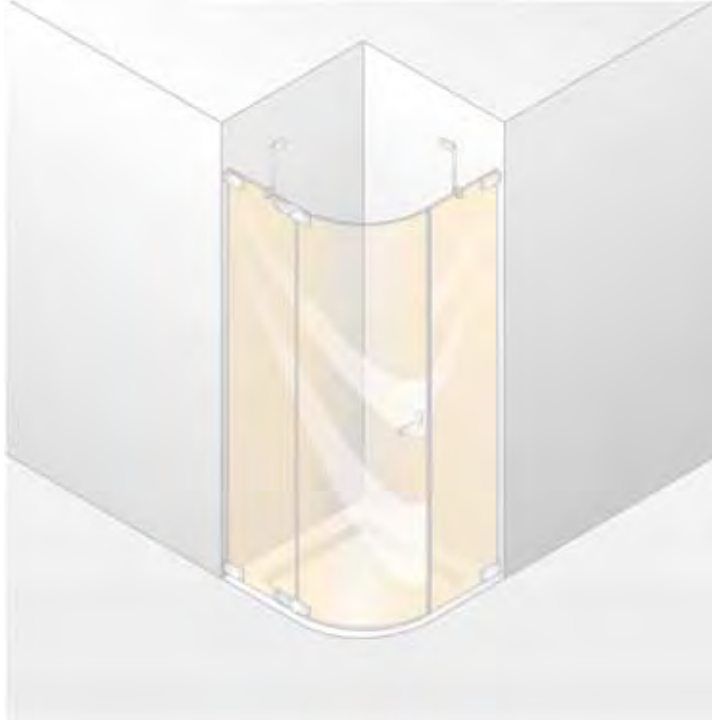

HÜPPE Studio Berlin pure

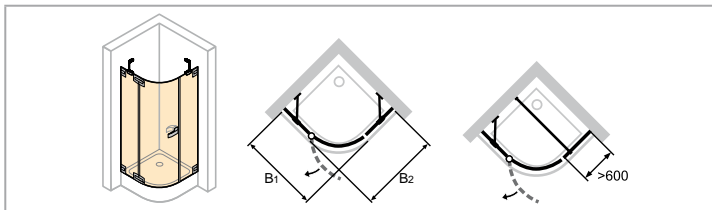
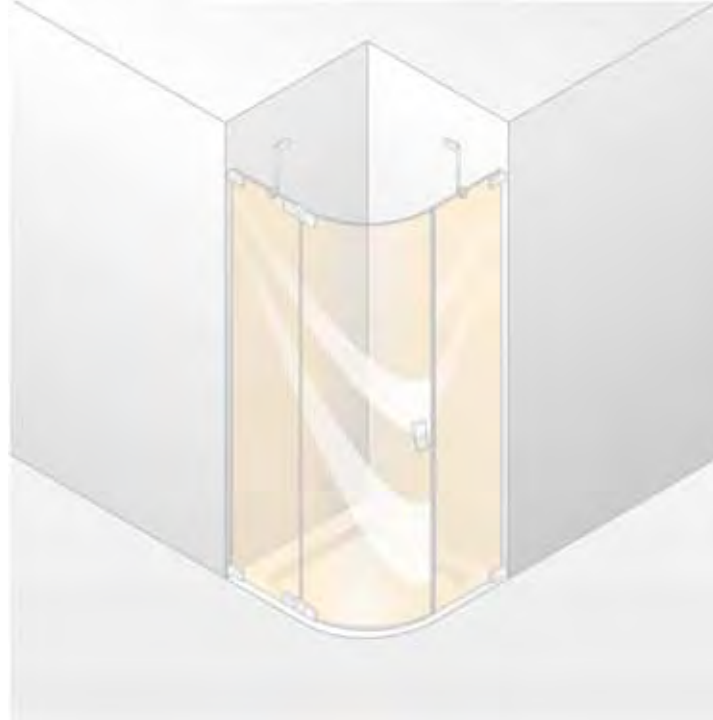

Left-hand fixing

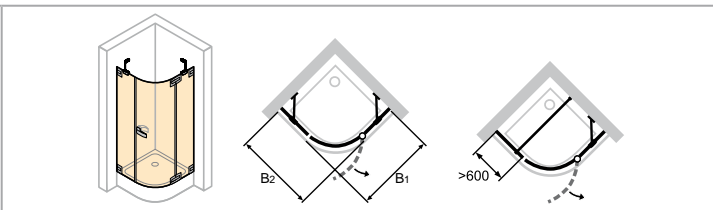

Right-hand fixing

- Measurements must always be taken.
- Price including slopes and cut-outs.
- Chrome look sealing strip.
- Basic colour brilliant gold: drip deflector strip in pearl gold.
- The fixed segments on the door side are installed with a tilt of 5mm (at the top) towards the outside.
- Individual galvanised surfaces: stainless steel look, old brass, high grade brass.

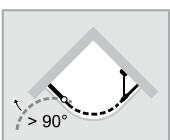
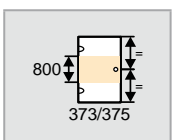
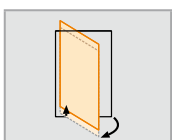
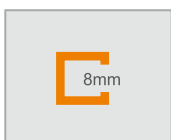

Swing door with fixed segments, 1-panel

Made-to-measure - Left-hand fixing

Height	Width B1	Width B2	Additional section width	Radius	PARIS	BERLIN	Base price
2000	700-1100	900-1000	210-600	500	PR1009	BR1009	3.115,-
	700-1100	900-2300	601-1800	500	PR100E	BR100E	3.508,-
	700-1100	900-1000	210-600	550	PR1209	BR1209	3.115,-
	700-1100	900-2300	601-1800	550	PR120E	BR120E	3.508,-

Additional section width > 600mm delivered with cross-bracing

Made-to-measure - Right-hand fixing

Height	Width B1	Width B2	Additional section width	Radius	PARIS	BERLIN	Base price
2000	700-1100	900-1000	210-600	500	PR1509	BR1509	3.115,-
	700-1100	900-2300	601-1800	500	PR150E	BR150E	3.508,-
	700-1100	900-1000	210-600	550	PR1709	BR1709	3.115,-
	700-1100	900-2300	601-1800	550	PR170E	BR170E	3.508,-

Additional section width > 600mm delivered with cross-bracing

Dim. Range: min. - max.

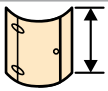
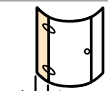
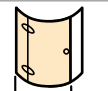
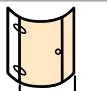
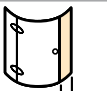
				
2000	210-600	700-1100	900-2300	210-1800

Colours - Panel options

Basic/inlay colours	Colour code	Extra charges
Black Edition	123	342,-
Individual RAL colours	998	606,-
Individual galvanised surfaces	999	1.452,-
Basic colours	Colour code	Extra charges
Fittings		
High-grade matt chrome	E	0,-
Chrome	C	354,-
Brilliant gold	G	500,-
Inlay colours	Colour code	Extra charges
Brilliant gold	02	0,-
High-grade matt chrome	05	
Black	23	
White	55	
Chrome	91	

Panel options	without Anti-Plaque		with Anti-Plaque	
	Glass code	Extra charges	Glass code	Extra charges
Clear	321	0,-	322	418,-
Karo	311	371,-	312	789,-
Sand Plus	315		316	
Privatima	373		375	

Further panel options - see chapter intro.

HÜPPE Studio Paris elegance frameless Pentagonal

HÜPPE Studio Berlin pure frameless Pentagonal

HÜPPE Studio Paris elegance

HÜPPE Studio Berlin pure

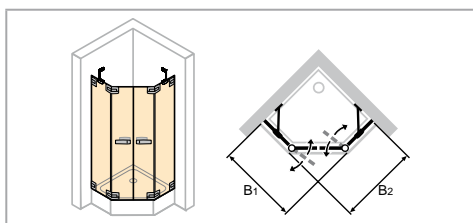
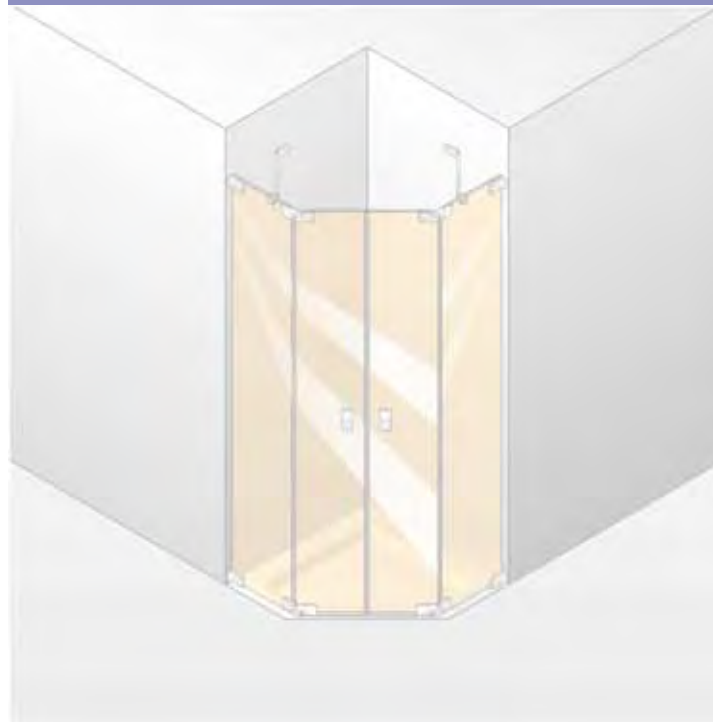
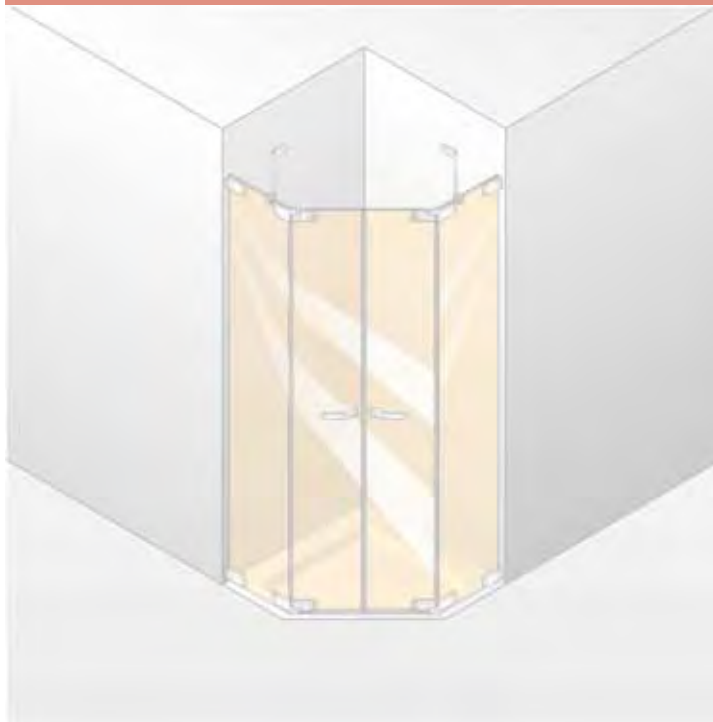

- Measurements must always be taken.
- Price including slopes and cut-outs.
- Chrome look sealing strip.
- Basic colour brilliant gold: drip deflector strip in pearl gold.
- Individual galvanised surfaces: stainless steel look, old brass, high grade brass.

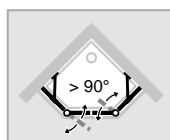
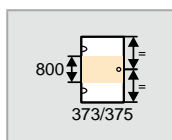
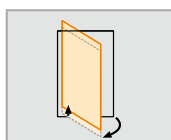
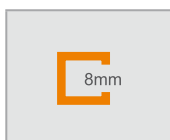

Swing door with fixed segments, 2-panel

Made-to-measure

Height	Width B1	Width B2	PARIS	BERLIN	Base price
1200-2000	700-1870	700-1870	PR5009	BR5009	3.537,-
2001-2200	700-1870	700-1870	PR500E	BR500E	4.230,-

Dim. Range: min. - max.

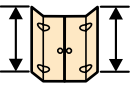
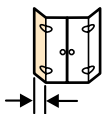
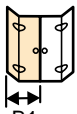
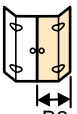
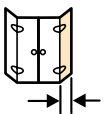
				
1200-2200	210-600	700-1870	700-1870	210-600

Special options

Optional variants		Extra charges
Bow-shaped handle	708	151,-
Individual handle from the HÜPPE range (not in brilliant gold and individual galvanised surfaces).	704	130,-

Colours - Panel options

Basic/inlay colours	Colour code	Extra charges
Black Edition	123	342,-
Individual RAL colours	998	606,-
Individual galvanised surfaces	999	1.452,-

Basic colours	Colour code	Extra charges
Fittings		
High-grade matt chrome	E	0,-
Chrome	C	354,-
Brilliant gold	G	500,-

Inlay colours	Colour code	Extra charges
Brilliant gold	02	0,-
High-grade matt chrome	05	
Black	23	
White	55	
Chrome	91	

Panel options	without Anti-Plaque		with Anti-Plaque	
	Glass code	Extra charges	Glass code	Extra charges
Clear	321	0,-	322	418,-
Karo	311	371,-	312	789,-
Sand Plus	315		316	
Privatima	373		375	

Further panel options - see chapter intro.

HÜPPE Studio Paris elegance frameless Pentagonal

HÜPPE Studio Berlin pure frameless Pentagonal

HÜPPE Studio Paris elegance



HÜPPE Studio Berlin pure

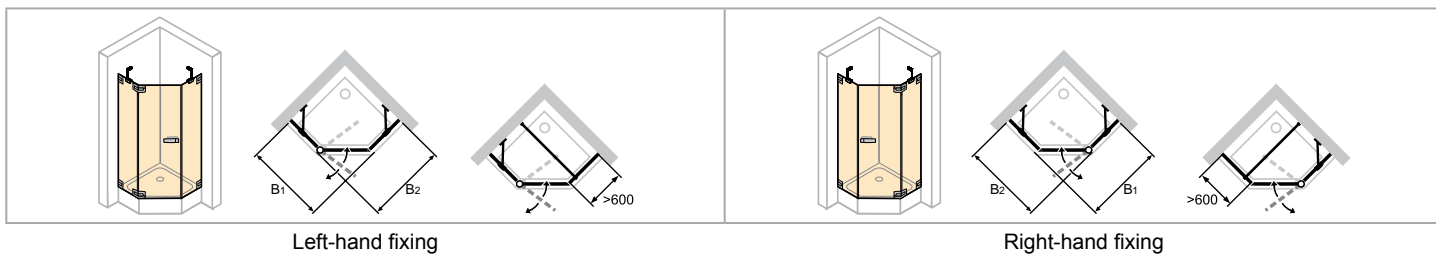

Left-hand fixing

Right-hand fixing

- Measurements must always be taken.
- Price including slopes and cut-outs.
- Chrome look sealing strip.
- Basic colour brilliant gold: drip deflector strip in pearl gold.
- Individual galvanised surfaces: stainless steel look, old brass, high grade brass.

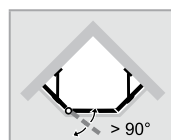
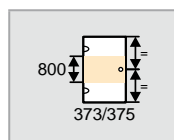
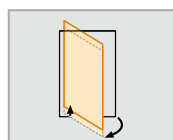
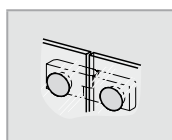
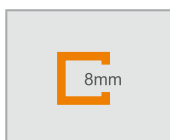

Swing door with fixed segments, 1-panel

Made-to-measure - Left-hand fixing

Height	Width B1	Width B2	Additional section width	PARIS	BERLIN	Base price
1200-2000	700-1230	700-1230	210-600	PR4009	BR4009	3.115,-
	700-1230	700-2430	601-1800	PR400E	BR400E	3.508,-
2001-2200	700-1230	700-1230	210-600	PR400F	BR400F	3.807,-
	700-1230	700-2430	601-1800	PR400G	BR400G	4.199,-

Additional section width > 600mm delivered with cross-bracing

Made-to-measure - Right-hand fixing

Height	Width B1	Width B2	Additional section width	PARIS	BERLIN	Base price
1200-2000	700-1230	700-1230	210-600	PR4509	BR4509	3.115,-
	700-1230	700-2430	601-1800	PR450E	BR450E	3.508,-
2001-2200	700-1230	700-1230	210-600	PR450F	BR450F	3.807,-
	700-1230	700-2430	601-1800	PR450G	BR450G	4.199,-

Additional section width > 600mm delivered with cross-bracing

Dim. Range: min. - max.

1200-2200	210-600	700-1230	700-2430	210-1800

Special options

Optional variants		Extra charges
Bow-shaped handle	708	151,-
Individual handle from the HÜPPE range (not in brilliant gold and individual galvanised surfaces).	704	130,-

Colours - Panel options

Basic/inlay colours	Colour code	Extra charges
Black Edition	123	342,-
Individual RAL colours	998	606,-
Individual galvanised surfaces	999	1.452,-

Basic colours	Colour code	Extra charges
Fittings		
High-grade matt chrome	E	0,-
Chrome	C	354,-
Brilliant gold	G	500,-

Inlay colours	Colour code	Extra charges
Brilliant gold	02	0,-
High-grade matt chrome	05	
Black	23	
White	55	
Chrome	91	

Panel options	without Anti-Plaque		with Anti-Plaque	
	Glass code	Extra charges	Glass code	Extra charges
Clear	321	0,-	322	418,-
Karo	311		312	
Sand Plus	315	371,-	316	789,-
Privatima	373		375	

Further panel options - see chapter intro.

HÜPPE Studio Paris elegance partially framed model overview - base price

HÜPPE Studio Berlin pure partially framed model overview - base price

Rectangular

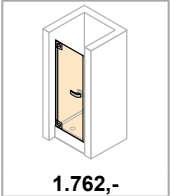
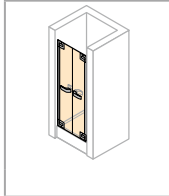
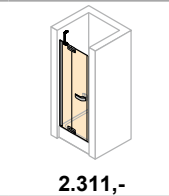
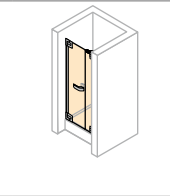
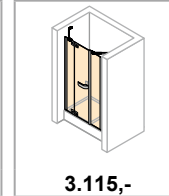
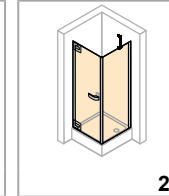
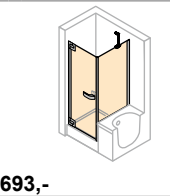
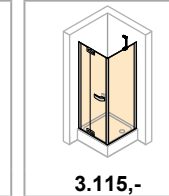
Swing door in recess  1.762,- R.10-R.11	Two-way door in recess  R.12-R.13	Swing door with fixed segment in recess  2.311,- R.14-R.15	Swing door with additional section in recess  R.16-R.17	Swing door with fixed segment and additional section in recess  3.115,- R.18-R.19	Swing door with side panel  R.20-R.21	Swing door with short side panel on bathtub  2.693,- R.22-R.23	Swing door with fixed segment and side panel  3.115,- R.24-R.27
---	--	---	--	--	---	---	--

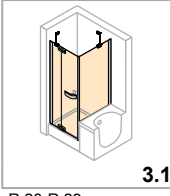
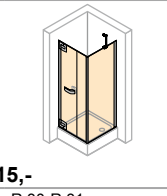
Swing door with fixed segment and shortened side panel on bathtub  R.28-R.29	Swing door with additional section and side panel  3.115,- R.30-R.31
--	---

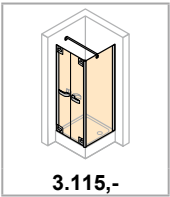
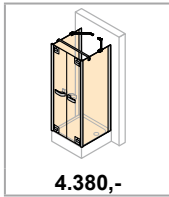
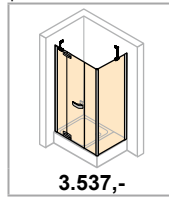
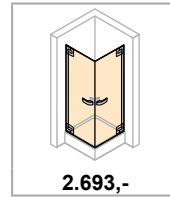
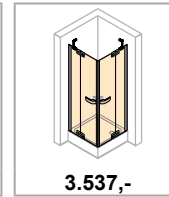
Two-way door with side panel  3.115,- R.32-R.33	Two-way door with two side panels as U-shaped enclosure  4.380,- R.34-R.35	Swing door with fixed segment, with additional section and side panel  3.537,- R.36-R.37	Swing door corner entry  2.693,- R.38-R.39	Swing door corner entry with fixed segments  3.537,- R.40-R.41
--	--	--	--	--

Quadrant

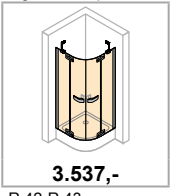
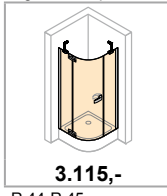
Swing door with fixed segments, 2-panel  3.537,- R.42-R.43	Swing door with fixed segments, 1-panel  3.115,- R.44-R.45
--	---

Pentagonal

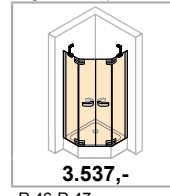
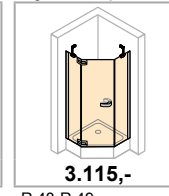
Swing door with fixed segments, 2-panel  3.537,- R.46-R.47	Swing door with fixed segments, 1-panel  3.115,- R.48-R.49
---	---

HÜPPE Studio Paris elegance partially framed model overview - base price

HÜPPE Studio Berlin pure partially framed model overview - base price

Walk-In

Free standing side panel

Free-standing side panel

Walk-In model 1

Walk-In model 2

Walk-In model 3

Walk-In model 4

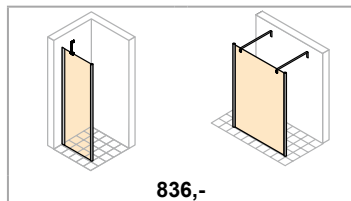

836,-

S.42-S.45

S.46-S.47

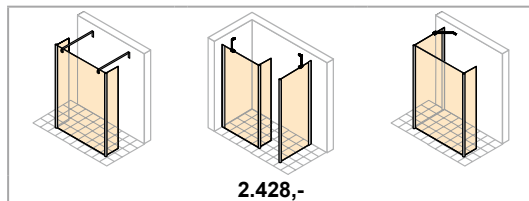

2.428,-

S.48-S.49

S.50-S.51

S.52-S.53

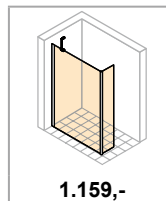

1.159,-

S.54-S.55

Bath-top shower screen

1-panel

1-panel with fixed segment

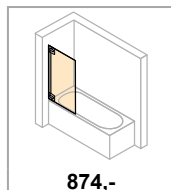

874,-

T.44-T.45

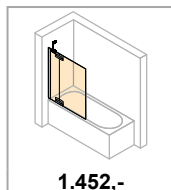

1.452,-

T.46-T.47

R
Studio Paris
Studio Berlin
partially framed

HÜPPE Studio Paris elegance partially framed
HÜPPE Studio Berlin pure partially framed





HÜPPE STUDIO

Our masterpiece.

HÜPPE Studio Paris elegance partially framed basic and inlay colours
HÜPPE Studio Berlin pure partially framed basic and inlay colours

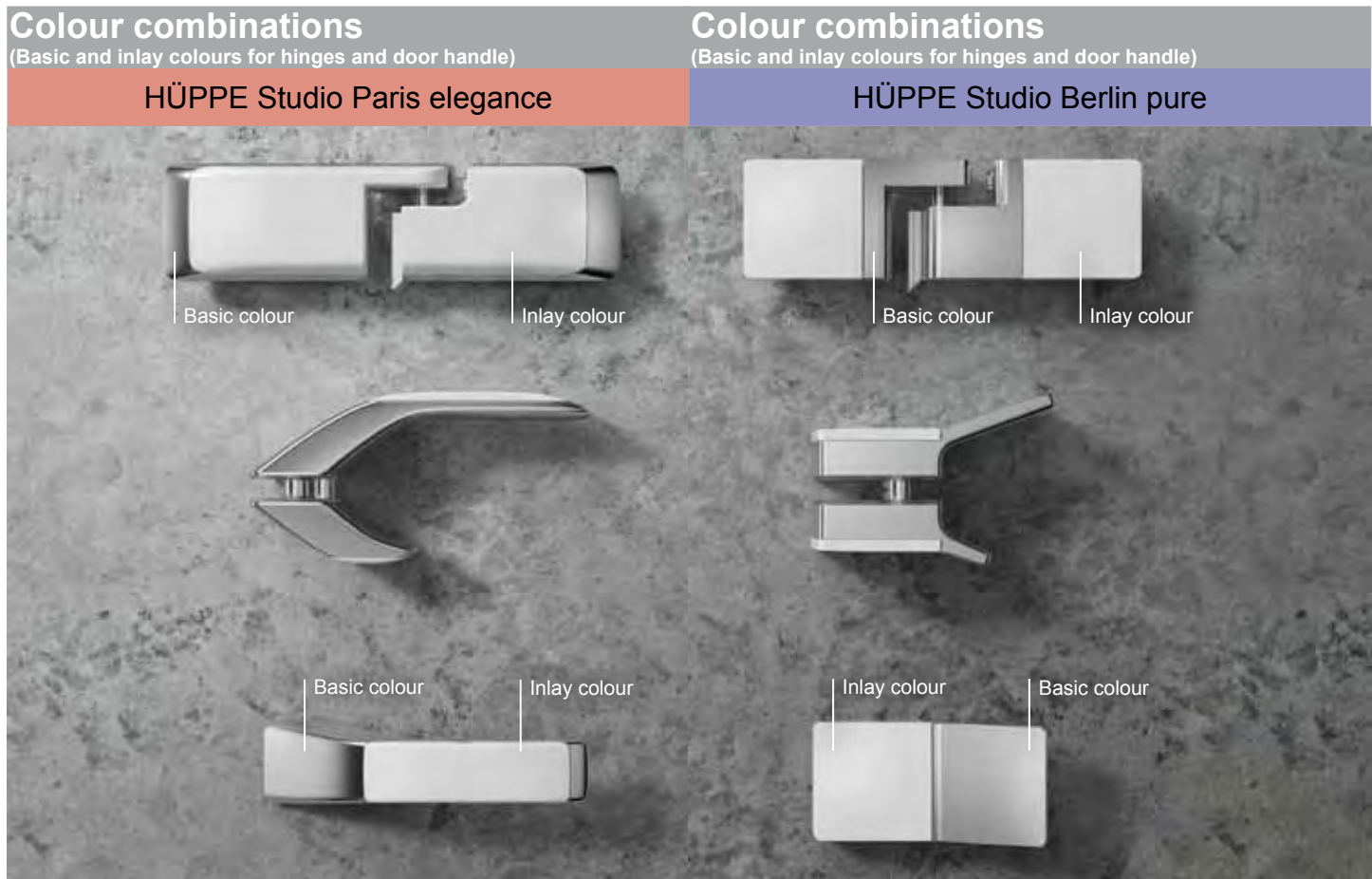

Basic and inlay colours (in any combination) Examples: with basic colour chrome		Basic and inlay colours (in any combination) Examples: with basic colour chrome	
HÜPPE Studio Paris elegance		HÜPPE Studio Berlin pure	
 <p>Basic colour: chrome Inlay colour: white</p>	 <p>Basic colour: chrome Inlay colour: high-grade matt chrome</p>	 <p>Basic colour: chrome Inlay colour: white</p>	 <p>Basic colour: chrome Inlay colour: high-grade matt chrome</p>
 <p>Basic colour: chrome Inlay colour: chrome</p>	 <p>Basic colour: chrome Inlay colour: black</p>	 <p>Basic colour: chrome Inlay colour: chrome</p>	 <p>Basic colour: chrome Inlay colour: black</p>
 <p>Basic colour: chrome Inlay colour: brilliant gold</p>		 <p>Basic colour: chrome Inlay colour: brilliant gold</p>	

Product details



Wall profile HÜPPE Studio Paris elegance



Design profile HÜPPE Studio Paris elegance



Wall profile HÜPPE Studio Berlin pure



Design profile HÜPPE Studio Berlin pure

Partly framed version with wall profile and round design profile as corner joint.



Installation with drip deflector strip



Installation without drip deflector strip for barrier-free entry



Innovative chrome-effect sealing strips



Bow-shaped handle HÜPPE Studio Paris elegance (available as an option)



Bow-shaped handle HÜPPE Studio Berlin pure (available as an option)

HÜPPE Studio Paris elegance partially framed panel options

HÜPPE Studio Berlin pure partially framed panel options



Nature

Panel options	Glass code	1 or 2 panels	3 or 4 panels
		Supplements per unit	Supplements per unit
Nature Anti-Plaquesand-blasted decor	366	353,-	706,-

- Sand-blasted decor dimensions: height 1400mm, position starting from bottom
- not available for quadrant models
- Due to technical production reasons, the decor may be offset from panel to panel.

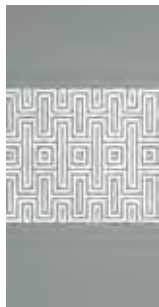

Orient

Panel options	Glass code	Supplements per unit	Supplements per unit
		Supplements per unit	Supplements per unit
Orient Anti-Plaquesand-blasted decor	305	353,-	706,-

- Sand-blasted decor dimensions: height 800mm, position central relative to unit height
- not available for quadrant models
- Due to technical production reasons, the decor may be offset from panel to panel.



Liquid

Panel options	Glass code	Supplements per unit	Supplements per unit
		Supplements per unit	Supplements per unit
Liquid Anti-Plaquesand-blasted decor	303	353,-	706,-

- Sand-blasted decor dimensions: height 830mm, position central relative to unit height
- not available for quadrant models
- Due to technical production reasons, the decor may be offset from panel to panel.



Sign

Panel options	Glass code	Supplements per unit	Supplements per unit
		Supplements per unit	Supplements per unit
Sign Anti-Plaquesand-blasted decor	363	353,-	706,-

- Sand-blasted decor dimensions: height 890mm, position central relative to unit height
- not available for quadrant models
- Due to technical production reasons, the decor may be offset from panel to panel.

HÜPPE Studio Paris elegance partially framed panel options

HÜPPE Studio Berlin pure partially framed panel options

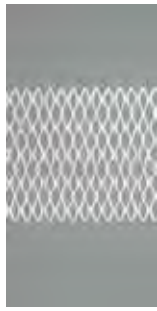

Loop

Panel options	Glass code	1 or 2 panels	3 or 4 panels
		Supplements per unit	Supplements per unit
Loop Anti-Plaque sand-blasted decor	306	353,-	706,-

- Sand-blasted decor dimensions: height 750mm, position central relative to unit height
- not available for quadrant models
- Due to technical production reasons, the decor may be offset from panel to panel.



Roses

Panel options	Glass code	Supplements per unit	Supplements per unit
		Roses Anti-Plaque sand-blasted decor	362

- Sand-blasted decor dimensions: height 810mm, position central relative to unit height
- not available for quadrant models
- Due to technical production reasons, the decor may be offset from panel to panel.



Royal

Panel options	Glass code	Supplements per unit	Supplements per unit
		Royal Anti-Plaque sand-blasted decor	365

- Sand-blasted decor dimensions: height 800mm, position central relative to unit height
- not available for quadrant models
- Due to technical production reasons, the decor may be offset from panel to panel.

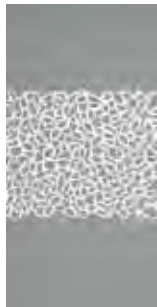

Leaves

Panel options	Glass code	Supplements per unit	Supplements per unit
		Leaves Anti-Plaque sand-blasted decor	304

- Sand-blasted decor dimensions: height 850mm, position central relative to unit height
- not available for quadrant models
- Due to technical production reasons, the decor may be offset from panel to panel.



Floral

Panel options	Glass code	Supplements per unit	Supplements per unit
		Floral Anti-Plaque sand-blasted decor	302

- Sand-blasted decor dimensions: height 800mm, width 850mm, located centrally with respect to unit width and height, 1 per front panel
- not available for quadrant models
- Due to technical production reasons, the decor may be offset from panel to panel.
- Walk-In models 1, 2, 3 and 4, floral decor only on the front panel.

HÜPPE Studio Paris elegance partially framed panel options

HÜPPE Studio Berlin pure partially framed panel options



Panel options	Glass code	1 or 2 panels	3 or 4 panels
		Supplements per unit	Supplements per unit
Grey Anti-Plaque	368	287,-	574,-

• not available for quadrant models



Panel options	Glass code	1 or 2 panels	3 or 4 panels
		Supplements per unit	Supplements per unit
Bronze Anti-Plaque	378	287,-	574,-

• not available for quadrant models



Panel options	Glass code	1 or 2 panels	3 or 4 panels
		Supplements per unit	Supplements per unit
Green Anti-Plaque	358	287,-	574,-

• not available for quadrant models



Panel options	Glass code	1 or 2 panels	3 or 4 panels
		Supplements per unit	Supplements per unit
Optiwhite Anti-Plaque	310	287,-	574,-

• not available for quadrant models



Panel options	Glass code	1 or 2 panels	3 or 4 panels
		Supplements per unit	Supplements per unit
Mastercarre Anti-Plaque	325	651,-	1.302,-

• not available for quadrant models



Panel options	Glass code	1 or 2 panels	3 or 4 panels
		Supplements per unit	Supplements per unit
Chinchilla Anti-Plaque	393	437,-	874,-

• not available for quadrant models

HÜPPE Studio Paris elegance partially framed panel options

HÜPPE Studio Berlin pure partially framed panel options

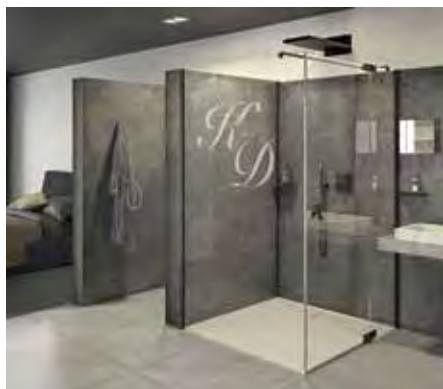

Panel options	Glass code	Supplement per panel
Individual I Anti-Plaques sand-blasted decor	359	281,-

- Initials
- Completely sand-blasted stripes

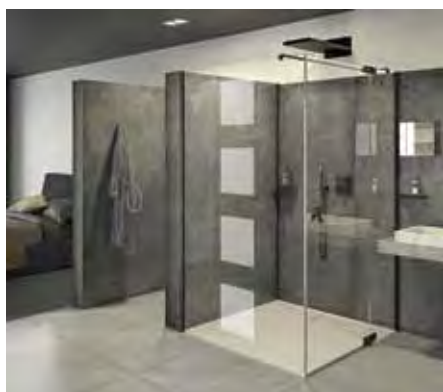

Panel options	Glass code	Supplement per panel
Individual II Anti-Plaques sand-blasted decor	360	514,-

- Simple decor, geometric shapes (stripes, squares, triangles)
- Simple logos

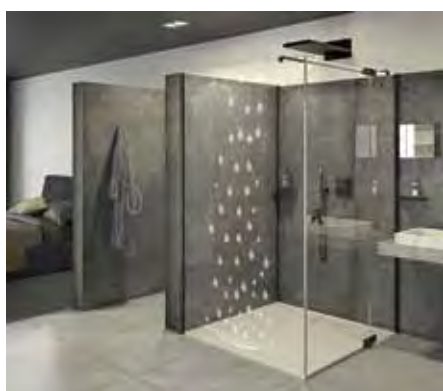

Panel options	Glass code	Supplement per panel
Individual III Anti-Plaques sand-blasted decor and other glass options	399	On request

- Stylish decors
- Stylish logos/crests

Extras

		Price
	Graphical representation/digitisation of individual decors	P00050000 338,-

HÜPPE Studio Paris elegance partially framed Rectangular
HÜPPE Studio Berlin pure partially framed Rectangular

HÜPPE Studio Paris elegance



HÜPPE Studio Berlin pure

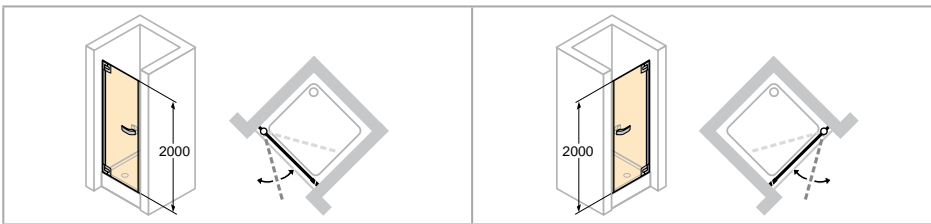

Left-hand fixing

Right-hand fixing

- Chrome look sealing strip.
- Price including slopes at top on closing side.

Dimensions	
	<p>WL: 33</p> <p>R: 13</p> <p>Mx: M+17</p> <p>MG: 30</p>
<p>WEM = Tray installation dim. (000)</p> <p>M = installation dimension Centre glass (001)</p> <p>Please always specify when ordering.</p>	

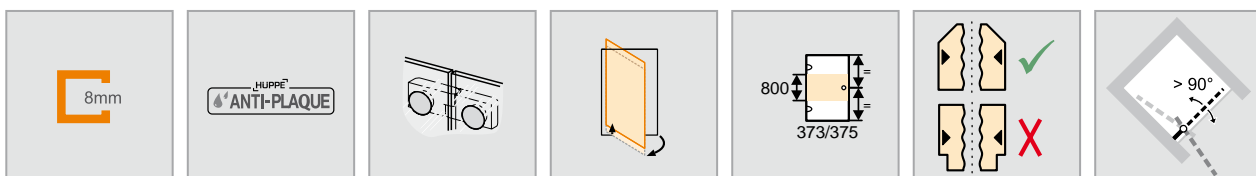

HÜPPE Studio Paris elegance partially framed Rectangular

HÜPPE Studio Berlin pure partially framed Rectangular

Swing door in recess

Left-hand fixing

Height	Model	WEM	M (middle of glass)	Pivoting range	Entry width	PARIS	BERLIN	Base price
2000	800	780-800	780-800	700	695	PT0001	BT0001	1.762,-
	900	880-900	880-900	800	795	PT0002	BT0002	
	1000	980-1000	980-1000	900	895	PT0003	BT0003	

Made-to-measure - Left-hand fixing

Height	Width of door front	PARIS	BERLIN	Base price
1200-2000	500-1000	PT0009	BT0009	1.762,-
2001-2200	500-900	PT000E	BT000E	2.108,-

Adjustment range = dimensions - 10mm / + 10mm

Right-hand fixing



Height	Model	WEM	M (middle of glass)	Pivoting range	Entry width	PARIS	BERLIN	Base price
2000	800	780-800	780-800	700	695	PT0011	BT0011	1.762,-
	900	880-900	880-900	800	795	PT0012	BT0012	
	1000	980-1000	980-1000	900	895	PT0013	BT0013	

Made-to-measure - Right-hand fixing

Height	Width of door front	PARIS	BERLIN	Base price
1200-2000	500-1000	PT0019	BT0019	1.762,-
2001-2200	500-900	PT001E	BT001E	2.108,-

Adjustment range = dimensions - 10mm / + 10mm

Dim. Range: min. - max.

	
1200-2000	500-1000
2001-2200	500-900

Special options

Optional variants		Extra charges
Bow-shaped handle	708	151,-
Individual handle from the HÜPPE range (not in brilliant gold and individual galvanised surfaces).	704	130,-

Colours - Panel options

Basic/inlay colours	Colour code	Extra charges
Black Edition	123	171,-
Individual RAL colours	998	303,-

Basic colours	Profile colour	Colour code	Extra charges
High-grade matt chrome	High-grade matt chrome	E	0,-
Chrome	High-gloss silver	C	177,-
Brilliant gold	pearl gold	G	250,-

Inlay colours	Colour code	Extra charges
Brilliant gold	02	0,-
High-grade matt chrome	05	
Black	23	
White	55	
Chrome	91	

Panel options	without Anti-Plaque		with Anti-Plaque	
	Glass code	Extra charges	Glass code	Extra charges
Clear	321	0,-	322	209,-
Karo	311	186,-	312	395,-
Sand Plus	315		316	
Privatima	373		375	
Mirror glass	380	439,-	381	648,-

Further panel options - see chapter intro.

HÜPPE Studio Paris elegance partially framed Rectangular

HÜPPE Studio Berlin pure partially framed Rectangular

HÜPPE Studio Paris elegance

HÜPPE Studio Berlin pure

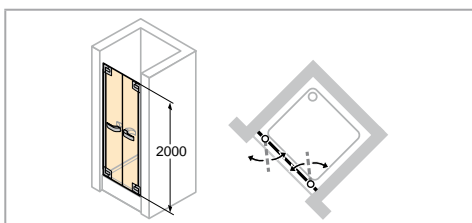
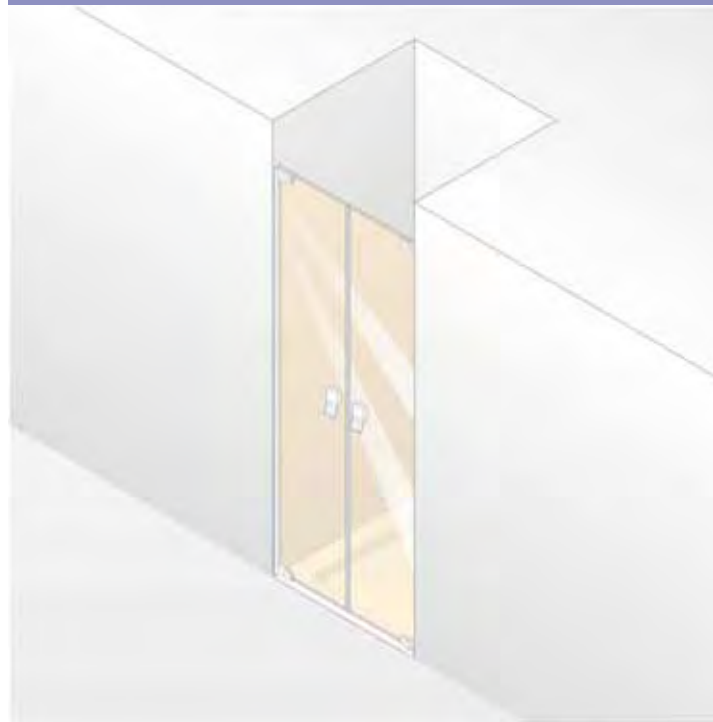
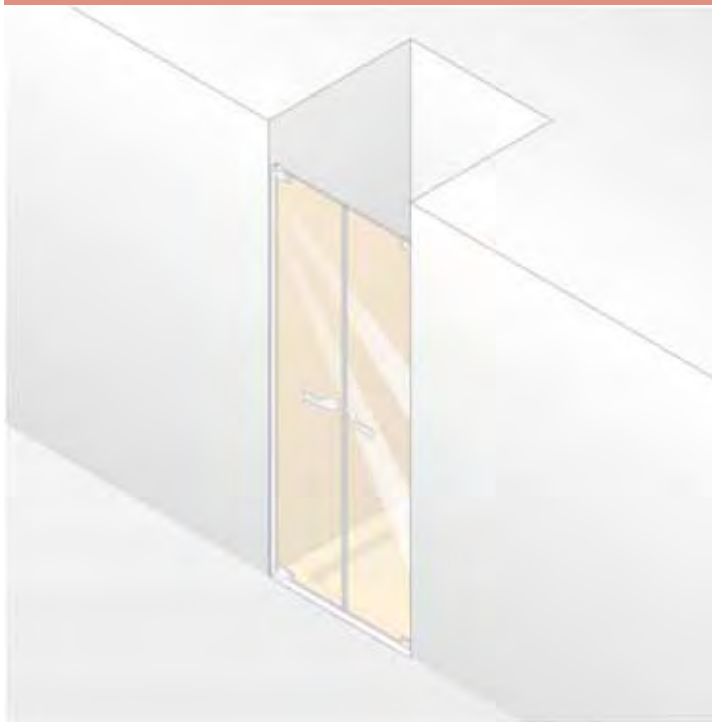

- Chrome look sealing strip.
- Mirror glass (380/381): Please state in your order which segment should be produced with mirror glass. If this is not stated, the entire unit will be produced with mirror glass.
- For technical information, see Profile Colours and Panel Options section.

Dimensions

WL: 33
R: 13
Mx: M+17
MG: 30

WEM = Tray installation dim. (000)
M = installation dimension Centre glass (001)
Please always specify when ordering.

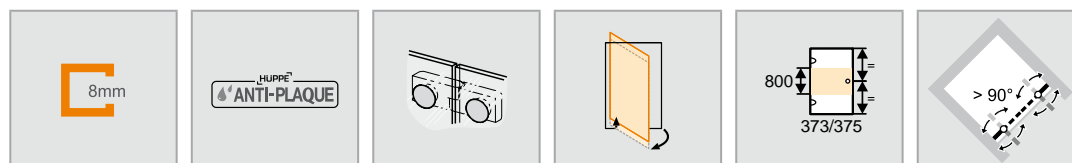

HÜPPE Studio Paris elegance partially framed Rectangular

HÜPPE Studio Berlin pure partially framed Rectangular

Two-way door in recess

Height	Model	WEM	M (middle of glass)	Pivoting range	Entry width	PARIS	BERLIN	Base price
2000	800	780-800	780-800	340	670	PT0061	BT0061	2.311,-
	900	880-900	880-900	380	770	PT0062	BT0062	
	1000	980-1000	980-1000	440	870	PT0063	BT0063	

Made-to-measure

Height	Width	PARIS	BERLIN	Base price
1200-2000	600-1200	PT0069	BT0069	2.311,-
	1201-2000	PT006E	BT006E	2.704,-
2001-2200	600-1200	PT006F	BT006F	2.658,-
	1201-1800	PT006G	BT006G	3.051,-

Adjustment range = dimensions - 10mm / + 10mm

Dim. Range: min. - max.

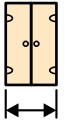
	
1200-2000	600-2000
2001-2200	600-1800

Special options

Optional variants		Extra charges
Bow-shaped handle	708	151,-
Individual handle from the HÜPPE range (not in brilliant gold and individual galvanised surfaces).	704	130,-

Colours - Panel options

Basic/inlay colours	Colour code	Extra charges
Black Edition	123	171,-
Individual RAL colours	998	303,-

Basic colours	Profile colour	Colour code	Extra charges
High-grade matt chrome	High-grade matt chrome	E	0,-
Chrome	High-gloss silver	C	177,-
Brilliant gold	pearl gold	G	250,-

Inlay colours	Colour code	Extra charges
Brilliant gold	02	0,-
High-grade matt chrome	05	
Black	23	
White	55	
Chrome	91	

Panel options	without Anti-Plaque		with Anti-Plaque	
	Glass code	Extra charges	Glass code	Extra charges
Clear	321	0,-	322	209,-
Karo	311	186,-	312	395,-
Sand Plus	315		316	
Privatima	373		375	
Mirror glass	380	439,-	381	648,-

Further panel options - see chapter intro.

HÜPPE Studio Paris elegance partially framed Rectangular

HÜPPE Studio Berlin pure partially framed Rectangular

HÜPPE Studio Paris elegance



HÜPPE Studio Berlin pure

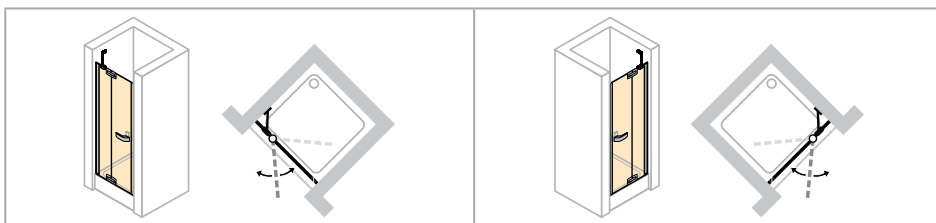

Left-hand fixing

Right-hand fixing

- Price including slopes and cut-outs.
- Chrome look sealing strip.
- Mirror glass (380/381): Please state in your order which segment should be produced with mirror glass. If this is not stated, the entire unit will be produced with mirror glass.
- For technical information, see Profile Colours and Panel Options section.

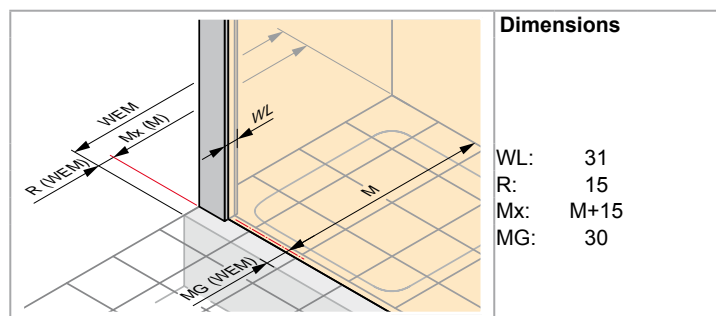

Dimensions

WL: 31
 R: 15
 Mx: M+15
 MG: 30

WEM = Tray installation dim. (000)
 M = installation dimension Centre glass (001)
 Please always specify when ordering.

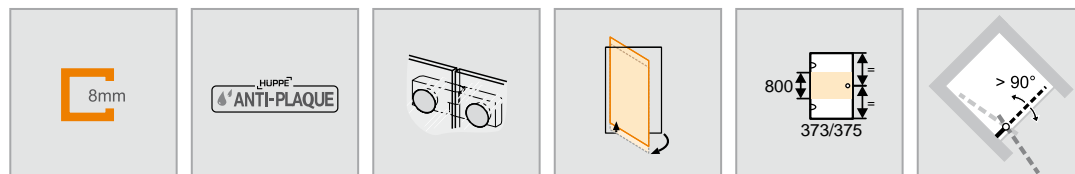

HÜPPE Studio Paris elegance partially framed Rectangular

HÜPPE Studio Berlin pure partially framed Rectangular

Swing door with fixed segment in recess

Made-to-measure - Left-hand fixing

Height	Width	PARIS	BERLIN	Base price
1200-2000	700-1200	PT0029	BT0029	2.311,-
	1201-1500	PT002E	BT002E	2.704,-
2001-2200	700-1200	PT002F	BT002F	2.658,-
	1201-1500	PT002G	BT002G	3.051,-

Adjustment range = dimensions - 10mm / + 10mm

Made-to-measure - Right-hand fixing

Height	Width	PARIS	BERLIN	Base price
1200-2000	700-1200	PT0039	BT0039	2.311,-
	1201-1500	PT003E	BT003E	2.704,-
2001-2200	700-1200	PT003F	BT003F	2.658,-
	1201-1500	PT003G	BT003G	3.051,-

Adjustment range = dimensions - 10mm / + 10mm

Dim. Range: min. - max.

1200-2200	700-1500	200-600	max. 900

Special options

Optional variants		Extra charges
Bow-shaped handle	708	151,-
Individual handle from the HÜPPE range (not in brilliant gold and individual galvanised surfaces).	704	130,-

Colours - Panel options

Basic/inlay colours	Colour code	Extra charges
Black Edition	123	171,-
Individual RAL colours	998	303,-

Basic colours	Profile colour	Colour code	Extra charges
High-grade matt chrome	High-grade matt chrome	E	0,-
Chrome	High-gloss silver	C	177,-
Brilliant gold	pearl gold	G	250,-

Inlay colours	Colour code	Extra charges
Brilliant gold	02	0,-
High-grade matt chrome	05	
Black	23	
White	55	
Chrome	91	

Panel options	without Anti-Plaque		with Anti-Plaque	
	Glass code	Extra charges	Glass code	Extra charges
Clear	321	0,-	322	209,-
Karo	311	186,-	312	395,-
Sand Plus	315		316	
Privatima	373		375	
Mirror glass	380	439,-	381	648,-

Further panel options - see chapter intro.

HÜPPE Studio Paris elegance partially framed Rectangular
HÜPPE Studio Berlin pure partially framed Rectangular

HÜPPE Studio Paris elegance



HÜPPE Studio Berlin pure

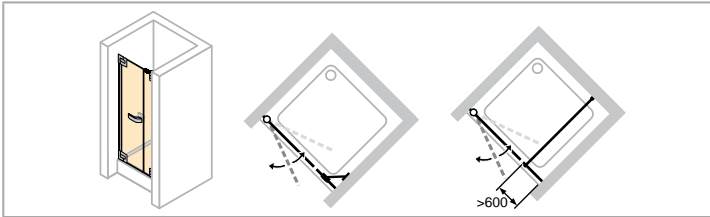

Left-hand fixing

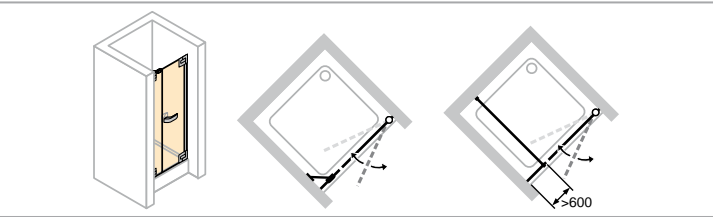

Right-hand fixing

- Price including slopes and cut-outs.
- Chrome look sealing strip.
- Mirror glass (380/381): Please state in your order which segment should be produced with mirror glass. If this is not stated, the entire unit will be produced with mirror glass.
- For technical information, see Profile Colours and Panel Options section.

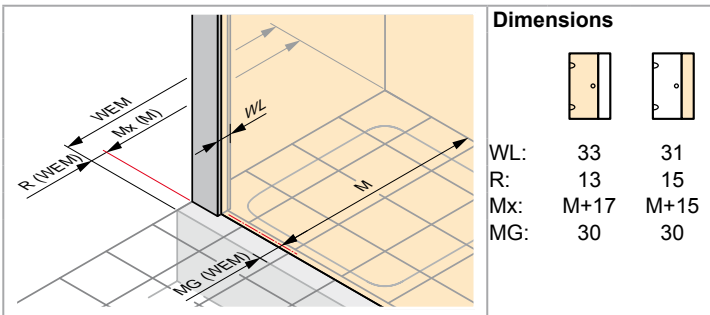

Dimensions

WL:	33	31
R:	13	15
Mx:	M+17	M+15
MG:	30	30

WEM = Tray installation dim. (000)
M = installation dimension Centre glass (001)
Please always specify when ordering.

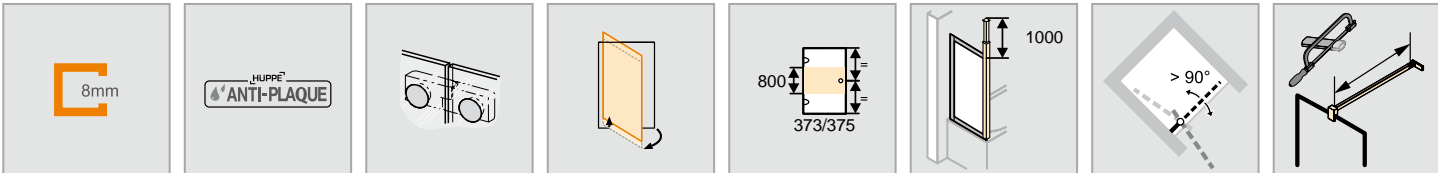

HÜPPE Studio Paris elegance partially framed Rectangular

HÜPPE Studio Berlin pure partially framed Rectangular

Swing door with additional section in recess

Made-to-measure - Left-hand fixing

Height	Width	PARIS	BERLIN	Base price
1200-2000	700-1200	PT0049	BT0049	2.311,-
	1201-2800	PT004E	BT004E	2.704,-
2001-2200	700-1200	PT004F	BT004F	2.658,-
	1201-2700	PT004G	BT004G	3.051,-

Adjustment range = dimensions - 10mm / + 10mm

Made-to-measure - Right-hand fixing

Height	Width	PARIS	BERLIN	Base price
1200-2000	700-1200	PT0059	BT0059	2.311,-
	1201-2800	PT005E	BT005E	2.704,-
2001-2200	700-1200	PT005F	BT005F	2.658,-
	1201-2700	PT005G	BT005G	3.051,-

Adjustment range = dimensions - 10mm / + 10mm

Dim. Range: min. - max.

1200-2000	700-2800	max. 1000	116-1800
2001-2200	700-2700	max. 900	116-1800

Special options

Optional variants		Extra charges
Bow-shaped handle	708	151,-
Design profile with ceiling connection. Ceiling connection min. 160mm	702	213,-
Bow-shaped handle and design profile with ceiling connection	709	364,-
Individual handle from the HÜPPE range (not in brilliant gold and individual galvanised surfaces).	704	130,-

Colours - Panel options

Basic/inlay colours	Colour code	Extra charges
Black Edition	123	171,-
Individual RAL colours	998	303,-

Basic colours	Profile colour	Colour code	Extra charges
High-grade matt chrome	High-grade matt chrome	E	0,-
Chrome	High-gloss silver	C	177,-
Brilliant gold	pearl gold	G	250,-

Inlay colours	Colour code	Extra charges
Brilliant gold	02	0,-
High-grade matt chrome	05	
Black	23	
White	55	
Chrome	91	

Panel options	without Anti-Plaque		with Anti-Plaque	
	Glass code	Extra charges	Glass code	Extra charges
Clear	321	0,-	322	209,-
Karo	311	186,-	312	395,-
Sand Plus	315		316	
Privatima	373		375	
Mirror glass	380	439,-	381	648,-

Further panel options - see chapter intro.

HÜPPE Studio Paris elegance partially framed Rectangular

HÜPPE Studio Berlin pure partially framed Rectangular

HÜPPE Studio Paris elegance

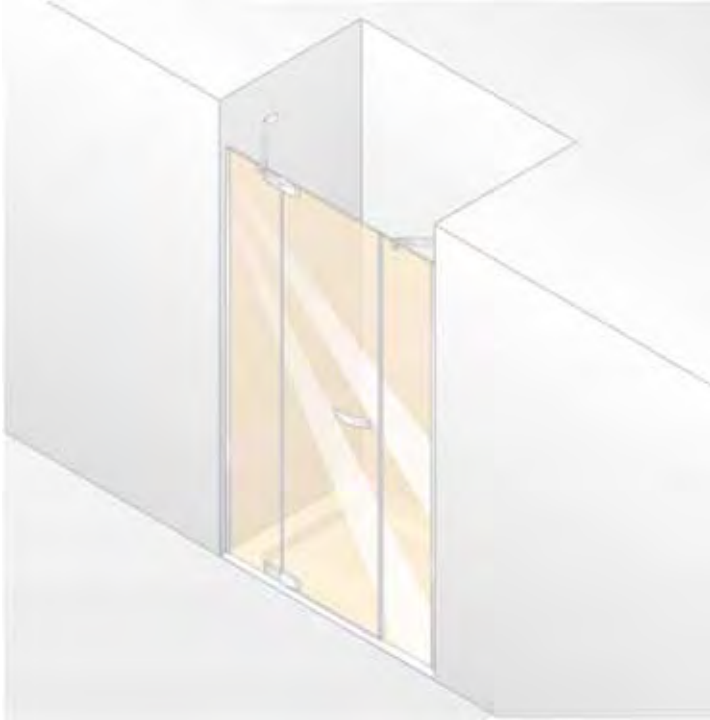

HÜPPE Studio Berlin pure

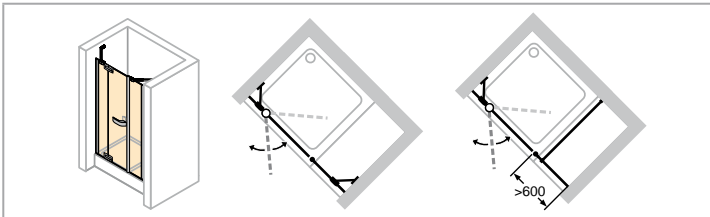

Left-hand fixing

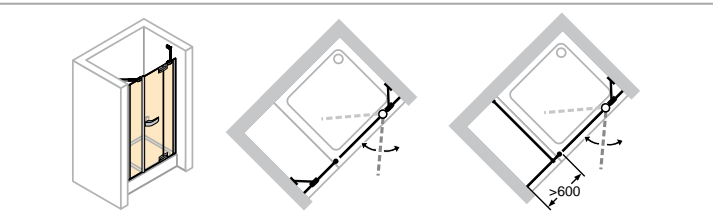

Right-hand fixing

- Price including slopes and cut-outs.
- Chrome look sealing strip.
- Mirror glass (380/381): Please state in your order which segment should be produced with mirror glass. If this is not stated, the entire unit will be produced with mirror glass.
- For technical information, see Profile Colours and Panel Options section.

Dimensions

WL: 31
R: 15
Mx: M+15
MG: 30

WEM = Tray installation dim. (000)
M = installation dimension Centre glass (001)
Please always specify when ordering.

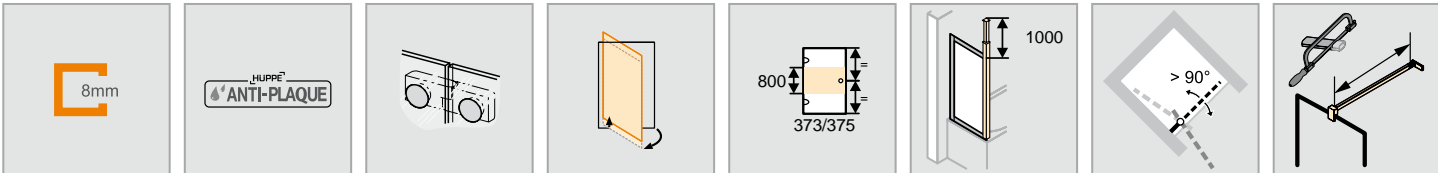

HÜPPE Studio Paris elegance partially framed Rectangular

HÜPPE Studio Berlin pure partially framed Rectangular

Swing door with fixed segment and additional section in recess

Made-to-measure - Left-hand fixing

Height	Width	PARIS	BERLIN	Base price
1200-2000	1000-1500	PT0089	BT0089	3.115,-
	1501-3300	PT008E	BT008E	3.508,-
2001-2200	1000-1500	PT008F	BT008F	3.460,-
	1501-3300	PT008G	BT008G	3.854,-

Adjustment range = dimensions - 10mm / + 10mm

Made-to-measure - Right-hand fixing

Height	Width	PARIS	BERLIN	Base price
1200-2000	1000-1500	PT0099	BT0099	3.115,-
	1501-3300	PT009E	BT009E	3.508,-
2001-2200	1000-1500	PT009F	BT009F	3.460,-
	1501-3300	PT009G	BT009G	3.854,-

Adjustment range = dimensions - 10mm / + 10mm

Dim. Range: min. - max.

1200-2200	1000-3300	200-600	max. 900	116-1800

Special options

Optional variants		Extra charges
Bow-shaped handle	708	151,-
Design profile with ceiling connection. Ceiling connection min. 160mm	702	213,-
Bow-shaped handle and design profile with ceiling connection	709	364,-
Individual handle from the HÜPPE range (not in brilliant gold and individual galvanised surfaces).	704	130,-

Colours - Panel options

Basic/inlay colours	Colour code	Extra charges
Black Edition	123	342,-
Individual RAL colours	998	606,-

Basic colours	Profile colour	Colour code	Extra charges
Fittings			
High-grade matt chrome	High-grade matt chrome	E	0,-
Chrome	High-gloss silver	C	354,-
Brilliant gold	pearl gold	G	500,-

Inlay colours	Colour code	Extra charges
Brilliant gold	02	0,-
High-grade matt chrome	05	
Black	23	
White	55	
Chrome	91	

Panel options	without Anti-Plaque		with Anti-Plaque	
	Glass code	Extra charges	Glass code	Extra charges
Clear	321	0,-	322	418,-
Karo	311		312	
Sand Plus	315	371,-	316	789,-
Privatima	373		375	
Mirror glass	380	439,-	381	857,-

Further panel options - see chapter intro.

HÜPPE Studio Paris elegance partially framed Rectangular
HÜPPE Studio Berlin pure partially framed Rectangular

HÜPPE Studio Paris elegance



HÜPPE Studio Berlin pure

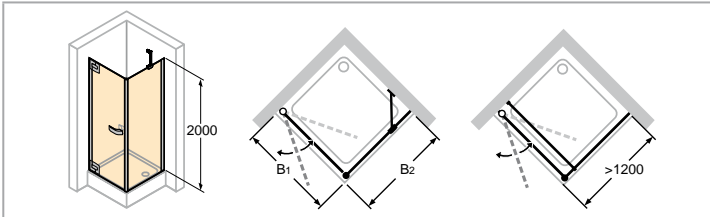

Left-hand fixing

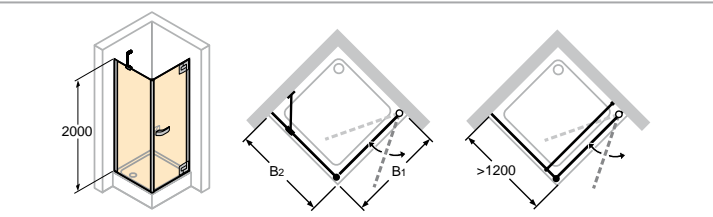

Right-hand fixing

- Price including slopes and cut-outs.
- Chrome look sealing strip.
- Ceiling connection: Standard max. 650mm. Made-to-measure 1000mm.
- Mirror glass (380/381): Please state in your order which segment should be produced with mirror glass. If this is not stated, the entire unit will be produced with mirror glass.
- For technical information, see Profile Colours and Panel Options section.
- Towel rail height can be selected individually and must be specified with the order. If nothing is specified, the towel rail is always delivered middle of glass (height and width).
- Installation of towel rail only possible on side panel.

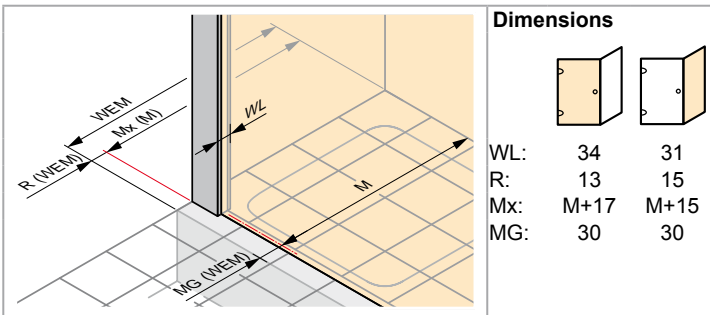

Dimensions

WL:	34	31
R:	13	15
Mx:	M+17	M+15
MG:	30	30

WEM = Tray installation dim. (000)
 M = installation dimension Centre glass (001)
 Please always specify when ordering.

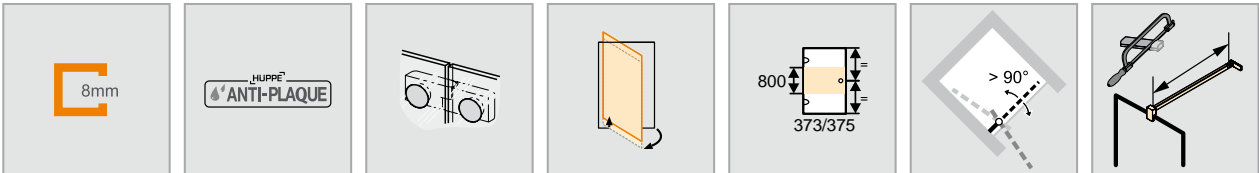

HÜPPE Studio Paris elegance partially framed Rectangular

HÜPPE Studio Berlin pure partially framed Rectangular

Swing door with side panel

Left-hand fixing

Height	Model B1/B2	WEM	M (middle of glass)	Entry width	PARIS	BERLIN	Base price
2000	800x800	790-800	760-770	685	PT0101	BT0101	2.693,-
	900x900	890-900	860-870	785	PT0102	BT0102	
	1000x1000	990-1000	960-970	885	PT0103	BT0103	

Made-to-measure - Left-hand fixing

Height	Width of door front	Width Side panel	PARIS	BERLIN	Base price
1200-2000	500-1000	300-1200	PT0109	BT0109	2.693,-
	500-1000	1201-1800	PT010E	BT010E	3.086,-
2001-2200	500-1000	300-1200	PT010F	BT010F	3.385,-
	500-1000	1201-1800	PT010G	BT010G	3.778,-

Adjustment range = dimensions - 5mm / + 5mm

Right-hand fixing

Height	Model B1/B2	WEM	M (middle of glass)	Entry width	PARIS	BERLIN	Base price
2000	800x800	790-800	760-770	685	PT0111	BT0111	2.693,-
	900x900	890-900	860-870	785	PT0112	BT0112	
	1000x1000	990-1000	960-970	885	PT0113	BT0113	

Made-to-measure - Right-hand fixing

Height	Width of door front	Width Side panel	PARIS	BERLIN	Base price
1200-2000	500-1000	300-1200	PT0119	BT0119	2.693,-
	500-1000	1201-1800	PT011E	BT011E	3.086,-
2001-2200	500-1000	300-1200	PT011F	BT011F	3.385,-
	500-1000	1201-1800	PT011G	BT011G	3.778,-

Adjustment range = dimensions - 5mm / + 5mm

Dim. Range: min. - max.

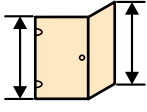
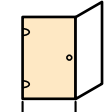
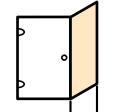
		
1200-2200	500-1000	300-1800

Special options

Optional variants		Extra charges
Bow-shaped handle	708	151,-
Design profile with ceiling connection. Ceiling connection min. 160mm	702	213,-
Bow-shaped handle and ceiling connection	709	364,-
Individual handle from the HÜPPE range (not in brilliant gold and individual galvanised surfaces).	704	130,-
Towel rail (high-gloss silver as standard, towel rail in black for Black Edition systems)	T99	210,-
Towel rail and bow-shaped handle	T08	361,-
Towel rail and ceiling connection. Ceiling connection min. 160mm.	T02	423,-
Towel rail, bow-shaped handle and ceiling connection. Ceiling connection min. 160mm.	T09	574,-
Towel rail and individual handle from the HÜPPE range (not in brilliant gold and individual galvanised surfaces)	T04	340,-

Colours - Panel options

Basic/inlay colours		Colour code	Extra charges
Black Edition		123	342,-
Individual RAL colours		998	606,-
Basic colours	Profile colour	Colour code	Extra charges
Fittings			
High-grade matt chrome	High-grade matt chrome	E	0,-
Chrome	High-gloss silver	C	354,-
Brilliant gold	pearl gold	G	500,-

Inlay colours	Colour code	Extra charges
Brilliant gold	02	0,-
High-grade matt chrome	05	
Black	23	
White	55	
Chrome	91	

Panel options	without Anti-Plaque		with Anti-Plaque	
	Glass code	Extra charges	Glass code	Extra charges
Clear	321	0,-	322	418,-
Karo	311	371,-	312	789,-
Sand Plus	315		316	
Privatima	373		375	
Mirror glass	380	439,-	381	857,-

Further panel options - see chapter intro.

HÜPPE Studio Paris elegance partially framed Rectangular
HÜPPE Studio Berlin pure partially framed Rectangular

HÜPPE Studio Paris elegance



HÜPPE Studio Berlin pure

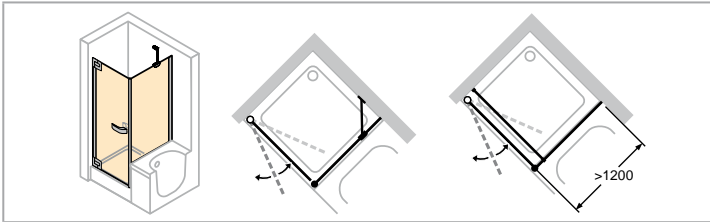

Left-hand fixing

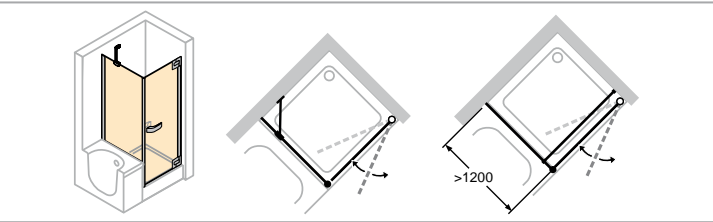

Right-hand fixing

- Price including slopes and cut-outs.
- Chrome look sealing strip.
- Mirror glass (380/381): Please state in your order which segment should be produced with mirror glass. If this is not stated, the entire unit will be produced with mirror glass.
- For technical information, see Profile Colours and Panel Options section.
- Towel rail height can be selected individually and must be specified with the order. If nothing is specified, the towel rail is always delivered middle of glass (height and width).
- Installation of towel rail only possible on side panel.

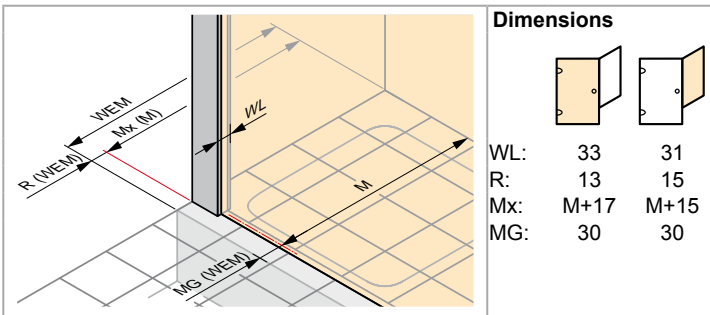

Dimensions

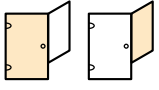

WL:	33	31
R:	13	15
Mx:	M+17	M+15
MG:	30	30

WEM = Tray installation dim. (000)
M = installation dimension Centre glass (001)
Please always specify when ordering.

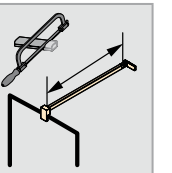
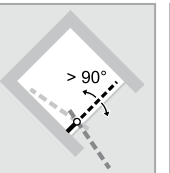
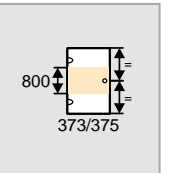
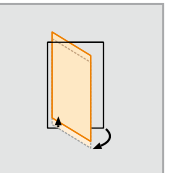
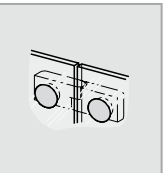
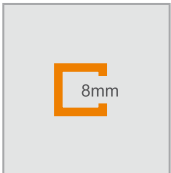

HÜPPE Studio Paris elegance partially framed Rectangular

HÜPPE Studio Berlin pure partially framed Rectangular

Swing door with short side panel on bathtub

Made-to-measure - Left-hand fixing

Height	Width Door front	Width Side panel	PARIS	BERLIN	Base price
1200-2000	500-1000	300-1200	PT0209	BT0209	2.693,-
	500-1000	1201-1800	PT020E	BT020E	3.086,-
2001-2200	500-900	300-1200	PT020F	BT020F	3.385,-
	500-900	1201-1800	PT020G	BT020G	3.778,-

Adjustment range = dimensions - 5mm / + 5mm

Made-to-measure - Right-hand fixing

Height	Width Door front	Width Side panel	PARIS	BERLIN	Base price
1200-2000	500-1000	300-1200	PT0219	BT0219	2.693,-
	500-1000	1201-1800	PT021E	BT021E	3.086,-
2001-2200	500-900	300-1200	PT021F	BT021F	3.385,-
	500-900	1201-1800	PT021G	BT021G	3.778,-

Adjustment range = dimensions - 5mm / + 5mm

Dim. Range: min. - max.

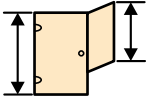
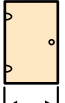
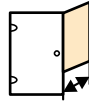
		
1200-2000	500-1000	300-1800
2001-2200	500-900	300-1800

Special options

Optional variants		Extra charges
Bow-shaped handle	708	151,-
Individual handle from the HÜPPE range (not in brilliant gold and individual galvanised surfaces).	704	130,-
Towel rail (high-gloss silver as standard, towel rail in black for Black Edition systems)	T99	210,-
Towel rail and bow-shaped handle	T08	361,-
Towel rail and individual handle from the HÜPPE range (not in brilliant gold and individual galvanised surfaces)	T04	340,-

Colours - Panel options

Basic/inlay colours	Colour code	Extra charges
Black Edition	123	342,-
Individual RAL colours	998	606,-

Basic colours	Profile colour	Colour code	Extra charges
Fittings			
High-grade matt chrome	High-grade matt chrome	E	0,-
Chrome	High-gloss silver	C	354,-
Brilliant gold	pearl gold	G	500,-

Inlay colours	Colour code	Extra charges
Brilliant gold	02	0,-
High-grade matt chrome	05	
Black	23	
White	55	
Chrome	91	

Panel options	without Anti-Plaque		with Anti-Plaque	
	Glass code	Extra charges	Glass code	Extra charges
Clear	321	0,-	322	418,-
Karo	311	371,-	312	789,-
Sand Plus	315		316	
Privatima	373		375	
Mirror glass	380	439,-	381	857,-

Further panel options - see chapter intro.

HÜPPE Studio Paris elegance partially framed Rectangular
HÜPPE Studio Berlin pure partially framed Rectangular

HÜPPE Studio Paris elegance



HÜPPE Studio Berlin pure

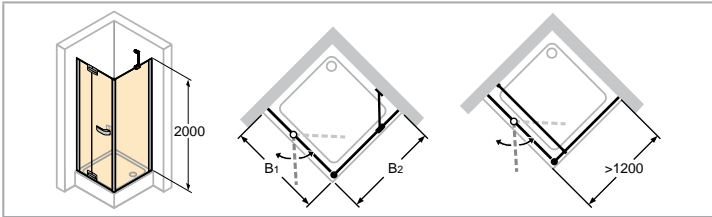

- Price including slopes and cut-outs.
- Chrome look sealing strip.
- Mirror glass (380/381): Please state in your order which segment should be produced with mirror glass. If this is not stated, the entire unit will be produced with mirror glass.
- For technical information, see Profile Colours and Panel Options section.
- Towel rail height can be selected individually and must be specified with the order. If nothing is specified, the towel rail is always delivered middle of glass (height and width).
- Installation of towel rail only possible on side panel.

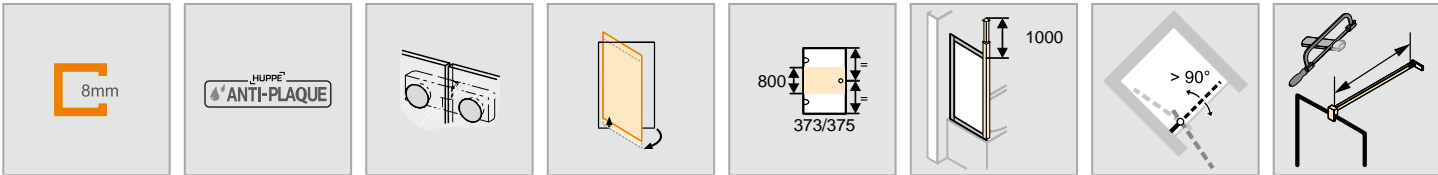
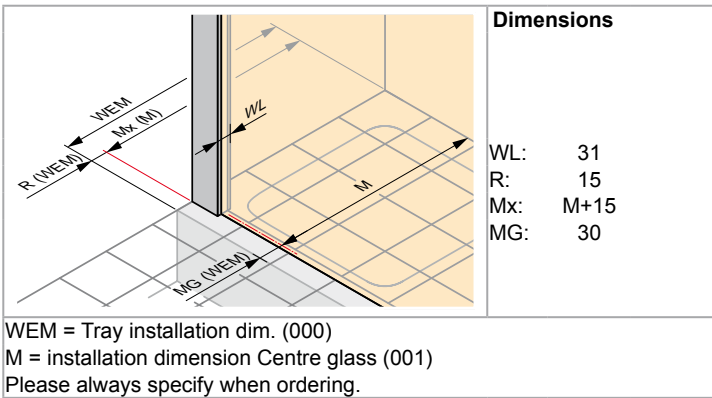

HÜPPE Studio Paris elegance partially framed Rectangular

HÜPPE Studio Berlin pure partially framed Rectangular

Swing door with fixed segment and side panel

Left-hand fixing

Height	Model B1/B2	WEM	M (middle of glass)	Pivoting range	Entry width	PARIS	BERLIN	Base price
2000	800x800	790-800	760-770	407	420	PT0121	BT0121	3.115,-
	900x900	890-900	860-870	507	520	PT0122	BT0122	
	1000x1000	990-1000	960-970	607	620	PT0123	BT0123	

Made-to-measure - Left-hand fixing

Height	Width of door front	Width Side panel	PARIS	BERLIN	Base price
1200-2000	700-1200	300-1200	PT0129	BT0129	3.115,-
	700-1200	1201-1800	PT012E	BT012E	3.508,-
	1201-1500	300-1200	PT012F	BT012F	3.901,-
2001-2200	1201-1500	1201-1800	PT012G	BT012G	3.807,-
	700-1200	300-1200	PT012H	BT012H	4.199,-
	700-1200	1201-1800	PT012I	BT012I	4.593,-
	1201-1500	300-1200	PT012J	BT012J	4.593,-

Adjustment range = dimensions - 5mm / + 5mm

Dim. Range: min. - max.

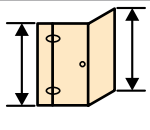
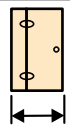
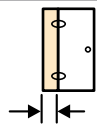
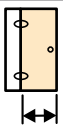
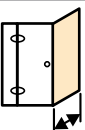
				
1200-2200	700-1500	200-600	max. 900	300-1800

Special options

Optional variants		Extra charges
Bow-shaped handle	708	151,-
Design profile with ceiling connection. Ceiling connection min. 160mm	702	213,-
Bow-shaped handle and ceiling connection	709	364,-
Individual handle from the HÜPPE range (not in brilliant gold and individual galvanised surfaces).	704	130,-
Towel rail (high-gloss silver as standard, towel rail in black for Black Edition systems)	T99	210,-
Towel rail and bow-shaped handle	T08	361,-
Towel rail and ceiling connection. Ceiling connection min. 160mm.	T02	423,-
Towel rail, bow-shaped handle and ceiling connection. Ceiling connection min. 160mm.	T09	574,-
Towel rail and individual handle from the HÜPPE range (not in brilliant gold and individual galvanised surfaces)	T04	340,-

Colours - Panel options

Basic/inlay colours		Colour code	Extra charges
Black Edition		123	342,-
Individual RAL colours		998	606,-
Basic colours	Profile colour	Colour code	Extra charges
Fittings			
High-grade matt chrome	High-grade matt chrome	E	0,-
Chrome	High-gloss silver	C	354,-
Brilliant gold	pearl gold	G	500,-
Inlay colours		Colour code	Extra charges
Brilliant gold		02	0,-
High-grade matt chrome		05	
Black		23	
White		55	
Chrome		91	

Panel options	without Anti-Plaque		with Anti-Plaque	
	Glass code	Extra charges	Glass code	Extra charges
Clear	321	0,-	322	418,-
Karo	311	371,-	312	789,-
Sand Plus	315		316	
Privatima	373		375	
Mirror glass	380	439,-	381	857,-

Further panel options - see chapter intro.

HÜPPE Studio Paris elegance partially framed Rectangular
HÜPPE Studio Berlin pure partially framed Rectangular

HÜPPE Studio Paris elegance



HÜPPE Studio Berlin pure

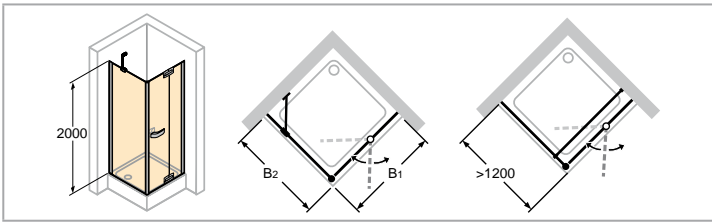

- Price including slopes and cut-outs.
- Chrome look sealing strip.
- Mirror glass (380/381): Please state in your order which segment should be produced with mirror glass. If this is not stated, the entire unit will be produced with mirror glass.
- For technical information, see Profile Colours and Panel Options section.
- Towel rail height can be selected individually and must be specified with the order. If nothing is specified, the towel rail is always delivered middle of glass (height and width).
- Installation of towel rail only possible on side panel.

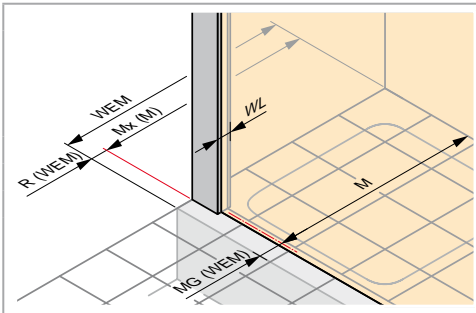

Dimensions

WL: 31
R: 15
Mx: M+15
MG: 30

WEM = Tray installation dim. (000)
M = installation dimension Centre glass (001)
Please always specify when ordering.

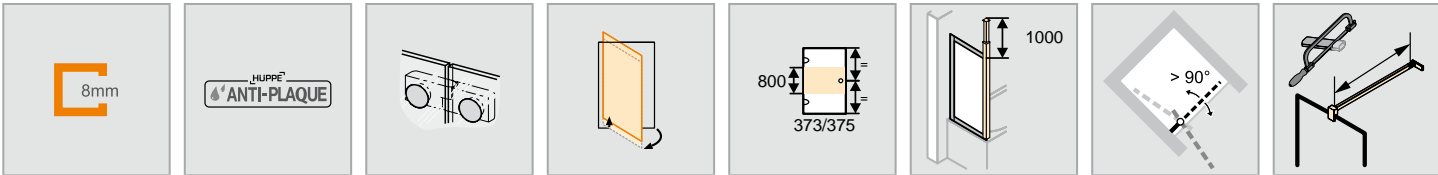

HÜPPE Studio Paris elegance partially framed Rectangular

HÜPPE Studio Berlin pure partially framed Rectangular

Swing door with fixed segment and side panel

Right-hand fixing

Height	Model B1/B2	WEM	M (middle of glass)	Pivoting range	Entry width	PARIS	BERLIN	Base price
2000	800x800	790-800	760-770	407	420	PT0131	BT0131	3.115,-
	900x900	890-900	860-870	507	520	PT0132	BT0132	
	1000x1000	990-1000	960-970	607	620	PT0133	BT0133	

Made-to-measure - Right-hand fixing

Height	Width of door front	Width Side panel	PARIS	BERLIN	Base price
1200-2000	700-1200	300-1200	PT0139	BT0139	3.115,-
	700-1200	1201-1800	PT013E	BT013E	3.508,-
	1201-1500	300-1200	PT013F	BT013F	3.901,-
2001-2200	1201-1500	1201-1800	PT013G	BT013G	3.807,-
	700-1200	300-1200	PT013H	BT013H	4.199,-
	700-1200	1201-1800	PT013I	BT013I	4.593,-
	1201-1500	300-1200	PT013J	BT013J	4.593,-

Adjustment range = dimensions - 5mm / + 5mm

Dim. Range: min. - max.

1200-2200	700-1500	200-600	max. 900	300-1800

Special options

Optional variants		Extra charges
Bow-shaped handle	708	151,-
Design profile with ceiling connection. Ceiling connection min. 160mm	702	213,-
Bow-shaped handle and ceiling connection	709	364,-
Individual handle from the HÜPPE range (not in brilliant gold and individual galvanised surfaces).	704	130,-
Towel rail (high-gloss silver as standard, towel rail in black for Black Edition systems)	T99	210,-
Towel rail and bow-shaped handle	T08	361,-
Towel rail and ceiling connection. Ceiling connection min. 160mm.	T02	423,-
Towel rail, bow-shaped handle and ceiling connection. Ceiling connection min. 160mm.	T09	574,-
Towel rail and individual handle from the HÜPPE range (not in brilliant gold and individual galvanised surfaces)	T04	340,-

Colours - Panel options

Basic/inlay colours		Colour code	Extra charges
Black Edition		123	342,-
Individual RAL colours		998	606,-
Basic colours	Profile colour	Colour code	Extra charges
Fittings			
High-grade matt chrome	High-grade matt chrome	E	0,-
Chrome	High-gloss silver	C	354,-
Brilliant gold	pearl gold	G	500,-

Inlay colours	Colour code	Extra charges
Brilliant gold	02	0,-
High-grade matt chrome	05	
Black	23	
White	55	
Chrome	91	

Panel options	without Anti-Plaque		with Anti-Plaque	
	Glass code	Extra charges	Glass code	Extra charges
Clear	321	0,-	322	418,-
Karo	311	371,-	312	789,-
Sand Plus	315		316	
Privatima	373		375	
Mirror glass	380	439,-	381	857,-

Further panel options - see chapter intro.

HÜPPE Studio Paris elegance partially framed Rectangular
HÜPPE Studio Berlin pure partially framed Rectangular

HÜPPE Studio Paris elegance

HÜPPE Studio Berlin pure

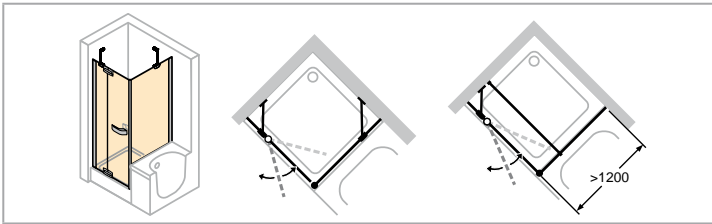
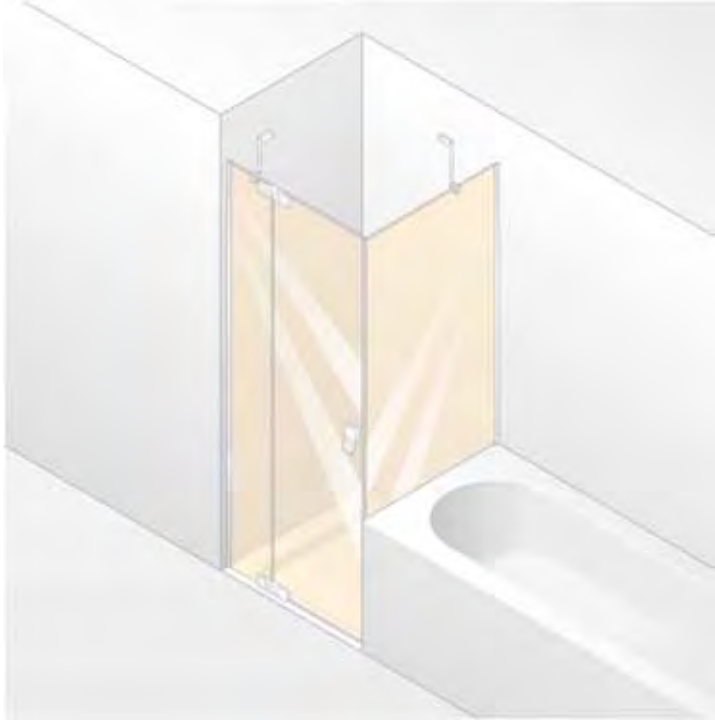
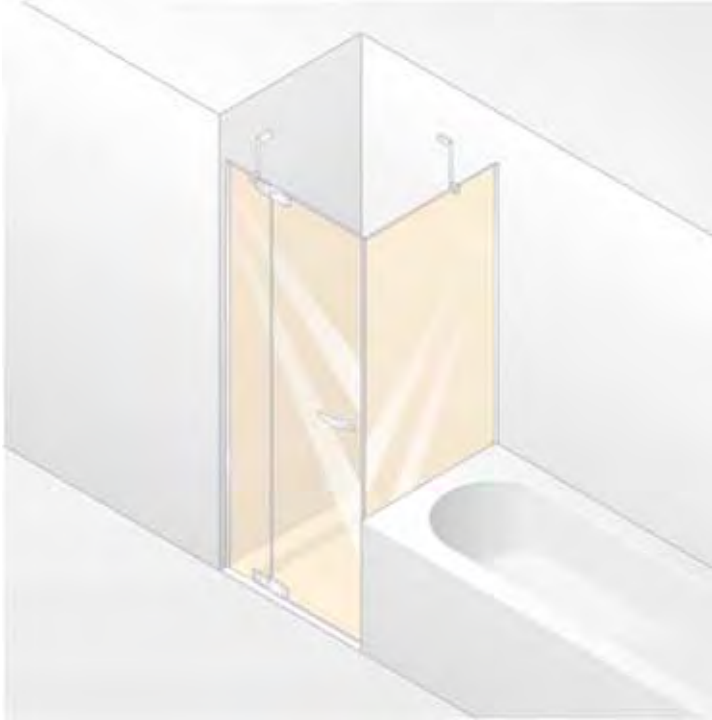

Left-hand fixing

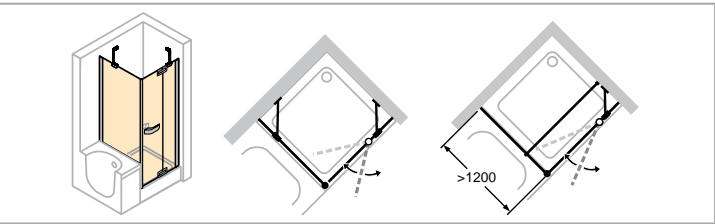

Right-hand fixing

- Price including slopes and cut-outs.
- Chrome look sealing strip.
- Mirror glass (380/381): Please state in your order which segment should be produced with mirror glass. If this is not stated, the entire unit will be produced with mirror glass.
- For technical information, see Profile Colours and Panel Options section.
- Towel rail height can be selected individually and must be specified with the order. If nothing is specified, the towel rail is always delivered middle of glass (height and width).
- Installation of towel rail only possible on side panel.

Dimensions

WL: 31
R: 15
Mx: M+15
MG: 30

WEM = Tray installation dim. (000)
M = installation dimension Centre glass (001)
Please always specify when ordering.

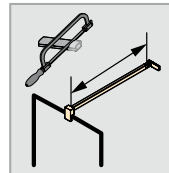
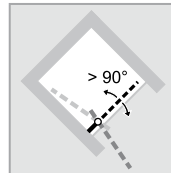
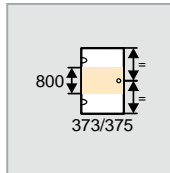
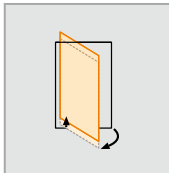
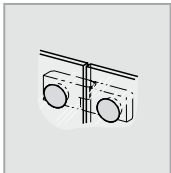
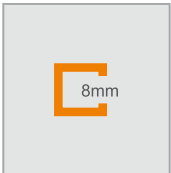

HÜPPE Studio Paris elegance partially framed Rectangular

HÜPPE Studio Berlin pure partially framed Rectangular

Swing door with fixed segment and shortened side panel on bathtub

Made-to-measure - Left-hand fixing

Height	Width Door front	Width Side panel	PARIS	BERLIN	Base price
1200-2000	700-1200	300-1200	PT0229	BT0229	3.115,-
	700-1200	1201-1800	PT022E	BT022E	3.508,-
	1201-1500	300-1200			
2001-2200	1201-1500	1201-1800	PT022F	BT022F	3.901,-
	700-1200	300-1200	PT022G	BT022G	3.807,-
	700-1200	1201-1800	PT022H	BT022H	4.199,-
1201-1500	300-1200				
	1201-1500	1201-1800	PT022J	BT022J	4.593,-

Adjustment range = dimensions - 5mm / + 5mm

Made-to-measure - Right-hand fixing

Height	Width Door front	Width Side panel	PARIS	BERLIN	Base price
1200-2000	700-1200	300-1200	PT0239	BT0239	3.115,-
	700-1200	1201-1800	PT023E	BT023E	3.508,-
	1201-1500	300-1200			
2001-2200	1201-1500	1201-1800	PT023F	BT023F	3.901,-
	700-1200	300-1200	PT023G	BT023G	3.807,-
	700-1200	1201-1800	PT023H	BT023H	4.199,-
1201-1500	300-1200				
	1201-1500	1201-1800	PT023J	BT023J	4.593,-

Adjustment range = dimensions - 5mm / + 5mm

Dim. Range: min. - max.

1200-2200	700-1500	200-600	max. 900	300-1800

Special options

Optional variants		Extra charges
Bow-shaped handle	708	151,-
Individual handle from the HÜPPE range (not in brilliant gold and individual galvanised surfaces).	704	130,-
Towel rail (high-gloss silver as standard, towel rail in black for Black Edition systems)	T99	210,-
Towel rail and bow-shaped handle	T08	361,-
Towel rail and individual handle from the HÜPPE range (not in brilliant gold and individual galvanised surfaces)	T04	340,-

Colours - Panel options

Basic/inlay colours		Colour code	Extra charges
Black Edition		123	342,-
Individual RAL colours		998	606,-
Basic colours	Profile colour	Colour code	Extra charges
Fittings			
High-grade matt chrome	High-grade matt chrome	E	0,-
Chrome	High-gloss silver	C	354,-
Brilliant gold	pearl gold	G	500,-
Inlay colours		Colour code	Extra charges
Brilliant gold		02	0,-
High-grade matt chrome		05	
Black		23	
White		55	
Chrome		91	

Panel options	without Anti-Plaque		with Anti-Plaque	
	Glass code	Extra charges	Glass code	Extra charges
Clear	321	0,-	322	418,-
Karo	311	371,-	312	789,-
Sand Plus	315		316	
Privatima	373		375	
Mirror glass	380	439,-	381	857,-

Further panel options - see chapter intro.

HÜPPE Studio Paris elegance partially framed Rectangular

HÜPPE Studio Berlin pure partially framed Rectangular

HÜPPE Studio Paris elegance

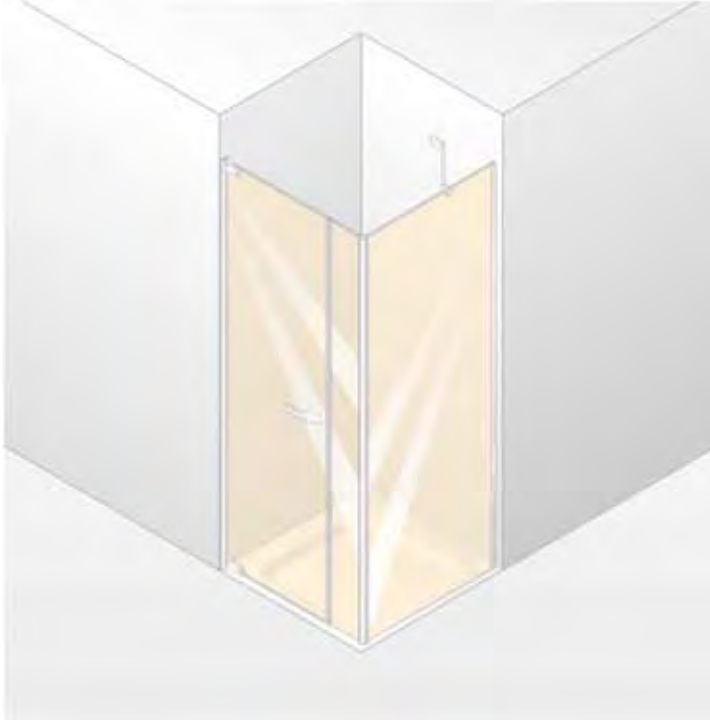

HÜPPE Studio Berlin pure

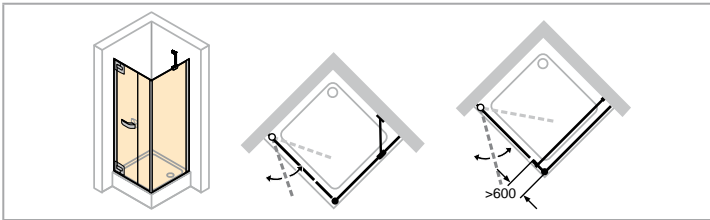
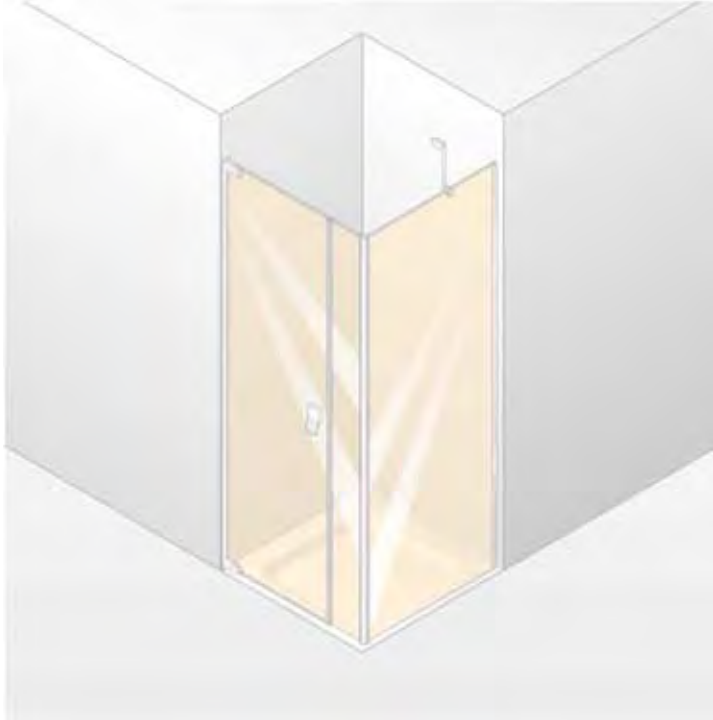

Left-hand fixing

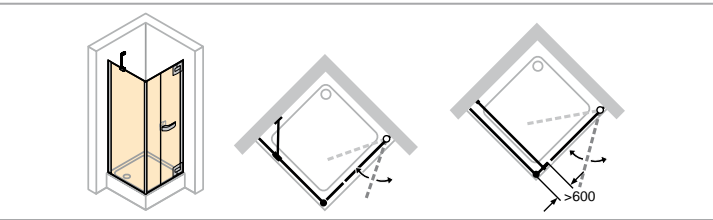

Right-hand fixing

- Price including slopes and cut-outs.
- Chrome look sealing strip.
- Mirror glass (380/381): Please state in your order which segment should be produced with mirror glass. If this is not stated, the entire unit will be produced with mirror glass.
- For technical information, see Profile Colours and Panel Options section.
- Towel rail height can be selected individually and must be specified with the order. If nothing is specified, the towel rail is always delivered middle of glass (height and width).
- Installation of towel rail only possible on side panel.

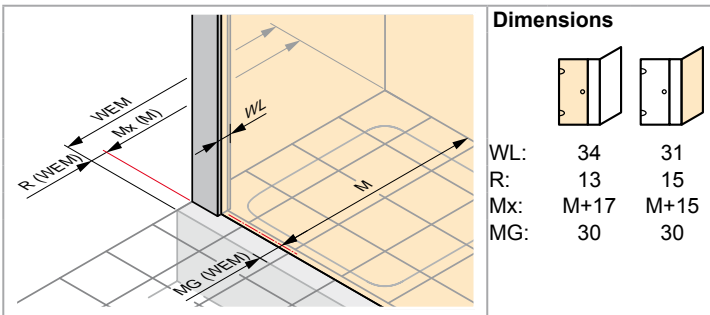

Dimensions

WL:	34	31
R:	13	15
Mx:	M+17	M+15
MG:	30	30

WEM = Tray installation dim. (000)
M = installation dimension Centre glass (001)
Please always specify when ordering.

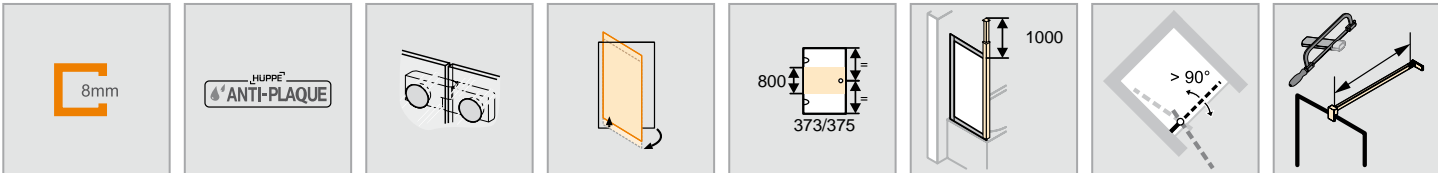

HÜPPE Studio Paris elegance partially framed Rectangular

HÜPPE Studio Berlin pure partially framed Rectangular

Swing door with additional section and side panel

Made-to-measure - Left-hand fixing

Height	Width Door front	Width Side panel	PARIS	BERLIN	Base price
1200-2000	700-1200	300-1200	PT0149	BT0149	3.115,-
	700-1200	1201-1800	PT014E	BT014E	3.508,-
	1201-2800	300-1200			
2001-2200	1201-2800	1201-1800	PT014F	BT014F	3.901,-
	700-1200	300-1200	PT014G	BT014G	3.807,-
	700-1200	1201-1800	PT014H	BT014H	4.199,-
	1201-2700	300-1200			
	1201-2700	1201-1800	PT014J	BT014J	4.593,-

Adjustment range = dimensions - 5mm / + 5mm

Made-to-measure - Right-hand fixing

Height	Width Door front	Width Side panel	PARIS	BERLIN	Base price
1200-2000	700-1200	300-1200	PT0159	BT0159	3.115,-
	700-1200	1201-1800	PT015E	BT015E	3.508,-
	1201-2800	300-1200			
2001-2200	1201-2800	1201-1800	PT015F	BT015F	3.901,-
	700-1200	300-1200	PT015G	BT015G	3.807,-
	700-1200	1201-1800	PT015H	BT015H	4.199,-
	1201-2700	300-1200			
	1201-2700	1201-1800	PT015J	BT015J	4.593,-

Adjustment range = dimensions - 5mm / + 5mm

Dim. Range: min. - max.

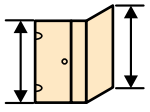
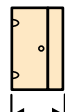
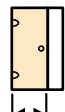
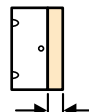
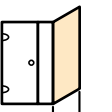
				
1200-2000	700-2800	max. 1000	116-1800	300-1800
2001-2200	700-2700	max. 900	116-1800	300-1800

Special options

Optional variants		Extra charges
Bow-shaped handle	708	151,-
Design profile with ceiling connection. Ceiling connection min. 160mm	702	213,-
Bow-shaped handle and ceiling connection	709	364,-
Individual handle from the HÜPPE range (not in brilliant gold and individual galvanised surfaces).	704	130,-
Towel rail (high-gloss silver as standard, towel rail in black for Black Edition systems)	T99	210,-
Towel rail and bow-shaped handle	T08	361,-
Towel rail and ceiling connection. Ceiling connection min. 160mm.	T02	423,-
Towel rail, bow-shaped handle and ceiling connection. Ceiling connection min. 160mm.	T09	574,-
Towel rail and individual handle from the HÜPPE range (not in brilliant gold and individual galvanised surfaces)	T04	340,-

Colours - Panel options

Basic/inlay colours	Colour code	Extra charges
Black Edition	123	342,-
Individual RAL colours	998	606,-

Basic colours	Profile colour	Colour code	Extra charges
Fittings			
High-grade matt chrome	High-grade matt chrome	E	0,-
Chrome	High-gloss silver	C	354,-
Brilliant gold	pearl gold	G	500,-

Inlay colours	Colour code	Extra charges
Brilliant gold	02	0,-
High-grade matt chrome	05	
Black	23	
White	55	
Chrome	91	

Panel options	without Anti-Plaque		with Anti-Plaque	
	Glass code	Extra charges	Glass code	Extra charges
Clear	321	0,-	322	418,-
Karo	311	371,-	312	789,-
Sand Plus	315		316	
Privatima	373		375	
Mirror glass	380	439,-	381	857,-

Further panel options - see chapter intro.

HÜPPE Studio Paris elegance partially framed Rectangular
HÜPPE Studio Berlin pure partially framed Rectangular

HÜPPE Studio Paris elegance



HÜPPE Studio Berlin pure

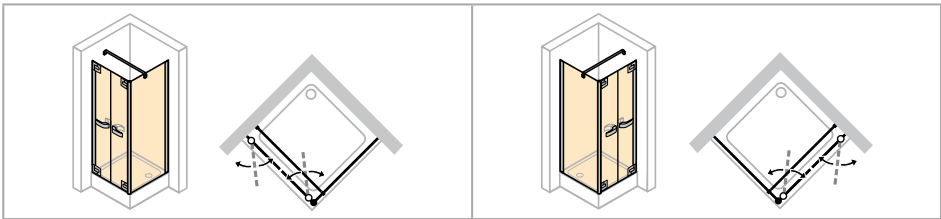

Left-hand fixing

Right-hand fixing

- Price including slopes and cut-outs.
- Chrome look sealing strip.
- Mirror glass (380/381): Please state in your order which segment should be produced with mirror glass. If this is not stated, the entire unit will be produced with mirror glass.
- For technical information, see Profile Colours and Panel Options section.
- Towel rail height can be selected individually and must be specified with the order. If nothing is specified, the towel rail is always delivered middle of glass (height and width).
- Installation of towel rail only possible on side panel.

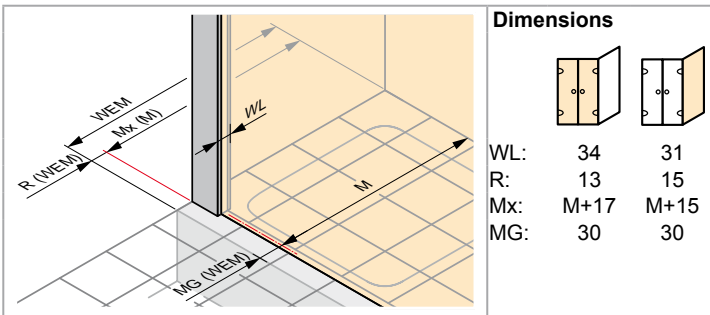

Dimensions

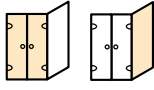

WL:	34	31
R:	13	15
Mx:	M+17	M+15
MG:	30	30

WEM = Tray installation dim. (000)
M = installation dimension Centre glass (001)
Please always specify when ordering.

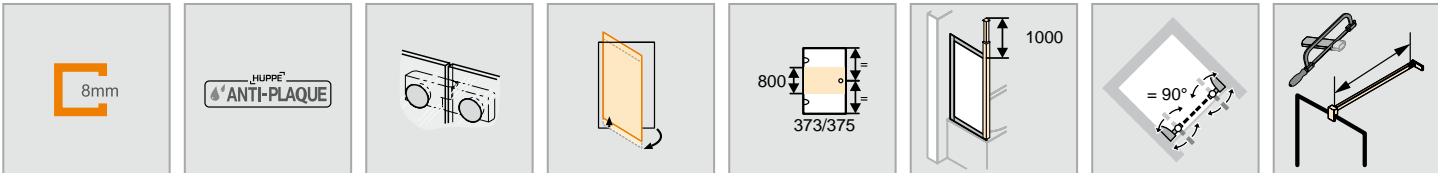

Two-way door with side panel

Made-to-measure - Left-hand fixing

Height	Width Door front	Width Side panel	PARIS	BERLIN	Base price
1200-2000	600-1200	300-1200	PT0169	BT0169	3.115,-
	600-1200	1201-1800	PT016E	BT016E	3.508,-
2001-2200	600-1200	300-1200	PT016F	BT016F	3.807,-
	600-1200	1201-1800	PT016G	BT016G	4.199,-

Adjustment range = dimensions - 5mm / + 5mm

Made-to-measure - Right-hand fixing

Height	Width Door front	Width Side panel	PARIS	BERLIN	Base price
1200-2000	600-1200	300-1200	PT0179	BT0179	3.115,-
	600-1200	1201-1800	PT017E	BT017E	3.508,-
2001-2200	600-1200	300-1200	PT017F	BT017F	3.807,-
	600-1200	1201-1800	PT017G	BT017G	4.199,-

Adjustment range = dimensions - 5mm / + 5mm

Dim. Range: min. - max.

1200-2200	600-1200	300-1800

Special options

Optional variants		Extra charges
Bow-shaped handle	708	151,-
Design profile with ceiling connection. Ceiling connection min. 160mm	702	213,-
Bow-shaped handle and ceiling connection	709	364,-
Individual handle from the HÜPPE range (not in brilliant gold and individual galvanised surfaces).	704	130,-
Towel rail (high-gloss silver as standard, towel rail in black for Black Edition systems)	T99	210,-
Towel rail and bow-shaped handle	T08	361,-
Towel rail and ceiling connection. Ceiling connection min. 160mm.	T02	423,-
Towel rail, bow-shaped handle and ceiling connection. Ceiling connection min. 160mm.	T09	574,-
Towel rail and individual handle from the HÜPPE range (not in brilliant gold and individual galvanised surfaces)	T04	340,-

Colours - Panel options

Basic/inlay colours	Colour code	Extra charges
Black Edition	123	342,-
Individual RAL colours	998	606,-

Basic colours	Profile colour	Colour code	Extra charges
Fittings			
High-grade matt chrome	High-grade matt chrome	E	0,-
Chrome	High-gloss silver	C	354,-
Brilliant gold	pearl gold	G	500,-

Inlay colours	Colour code	Extra charges
Brilliant gold	02	0,-
High-grade matt chrome	05	
Black	23	
White	55	
Chrome	91	

Panel options	without Anti-Plaque		with Anti-Plaque	
	Glass code	Extra charges	Glass code	Extra charges
Clear	321	0,-	322	418,-
Karo	311	371,-	312	789,-
Sand Plus	315		316	
Privatima	373		375	
Mirror glass	380	439,-	381	857,-

Further panel options - see chapter intro.

HÜPPE Studio Paris elegance partially framed Rectangular
HÜPPE Studio Berlin pure partially framed Rectangular

HÜPPE Studio Paris elegance

HÜPPE Studio Berlin pure

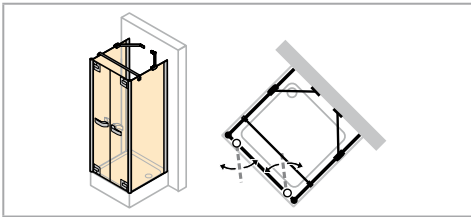
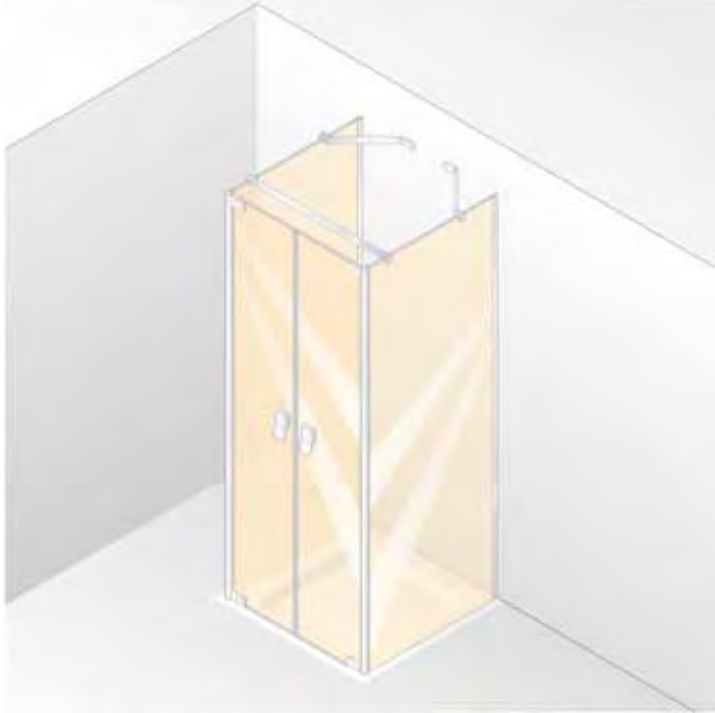
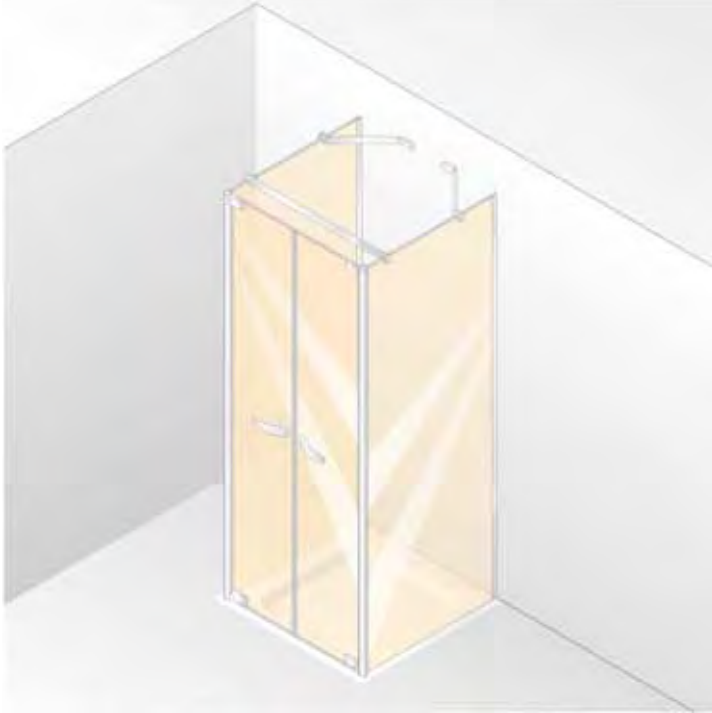

- Price including slopes and cut-outs.
- Chrome look sealing strip.
- Mirror glass (380/381): Please state in your order which segment should be produced with mirror glass. If this is not stated, the entire unit will be produced with mirror glass.
- For technical information, see Profile Colours and Panel Options section.
- Towel rail height can be selected individually and must be specified with the order. If nothing is specified, the towel rail is always delivered middle of glass (height and width).
- Installation of towel rail only possible on side panel.

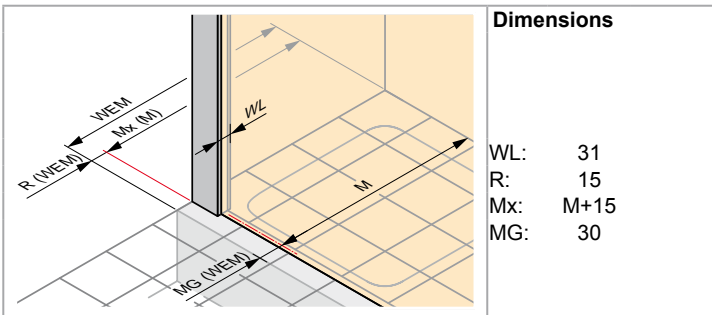

Dimensions

- WL: 31
- R: 15
- Mx: M+15
- MG: 30

WEM = Tray installation dim. (000)
M = installation dimension Centre glass (001)
Please always specify when ordering.

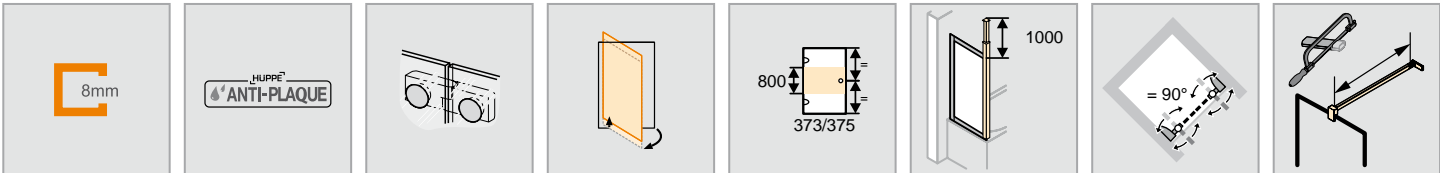

HÜPPE Studio Paris elegance partially framed Rectangular

HÜPPE Studio Berlin pure partially framed Rectangular

Two-way door with two side panels as U-shaped enclosure

Made-to-measure

Height	Width Door front	Width Side panel	PARIS	BERLIN	Base price
1200-2000	600-1200	300-1200	PT0669	BT0669	4.380,-
	600-1200	1201-1500	PT066E	BT066E	4.773,-
2001-2200	600-1200	300-1200	PT066F	BT066F	5.073,-
	600-1200	1201-1500	PT066G	BT066G	5.466,-

Adjustment range = dimensions - 5mm / + 5mm

Dim. Range: min. - max.

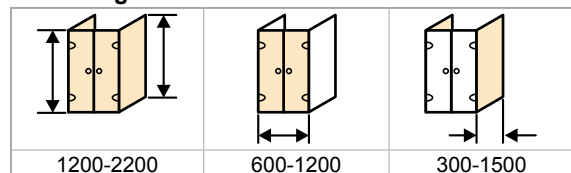

Special options

Optional variants		Extra charges
Bow-shaped handle	708	151,-
Design profile with ceiling connection. Ceiling connection min. 160mm	702	213,-
Bow-shaped handle and ceiling connection	709	364,-
Individual handle from the HÜPPE range (not in brilliant gold and individual galvanised surfaces).	704	130,-
Towel rail (high-gloss silver as standard, towel rail in black for Black Edition systems)	T99	210,-
Towel rail and bow-shaped handle	T08	361,-
Towel rail and ceiling connection. Ceiling connection min. 160mm.	T02	423,-
Towel rail, bow-shaped handle and ceiling connection. Ceiling connection min. 160mm.	T09	574,-
Towel rail and individual handle from the HÜPPE range (not in brilliant gold and individual galvanised surfaces)	T04	340,-

Colours - Panel options

Basic/inlay colours		Colour code	Extra charges
Black Edition		123	342,-
Individual RAL colours		998	606,-
Basic colours	Profile colour	Colour code	Extra charges
Fittings			
High-grade matt chrome	High-grade matt chrome	E	0,-
Chrome	High-gloss silver	C	354,-
Brilliant gold	pearl gold	G	500,-
Inlay colours		Colour code	Extra charges
Brilliant gold		02	0,-
High-grade matt chrome		05	
Black		23	
White		55	
Chrome		91	

Panel options	without Anti-Plaque		with Anti-Plaque	
	Glass code	Extra charges	Glass code	Extra charges
Clear	321	0,-	322	418,-
Karo	311	371,-	312	789,-
Sand Plus	315		316	
Privatima	373		375	
Mirror glass	380	439,-	381	857,-

Further panel options - see chapter intro.

HÜPPE Studio Paris elegance partially framed Rectangular

HÜPPE Studio Berlin pure partially framed Rectangular

HÜPPE Studio Paris elegance

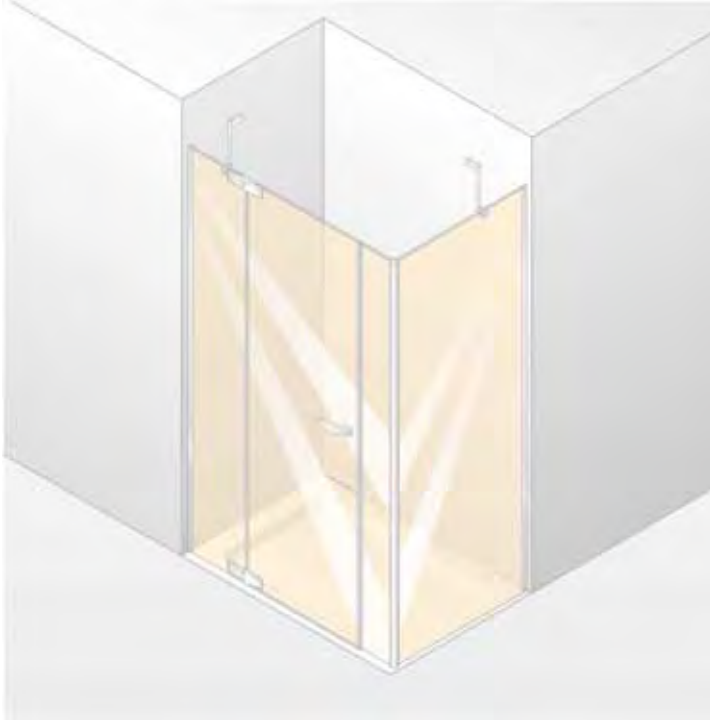

HÜPPE Studio Berlin pure

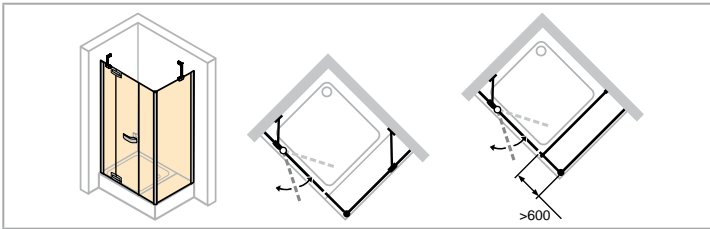
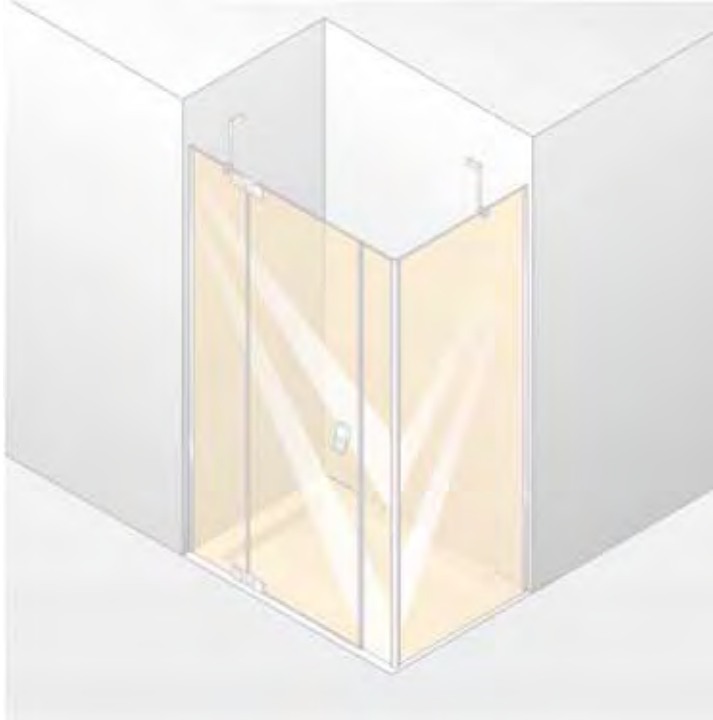

Left-hand fixing

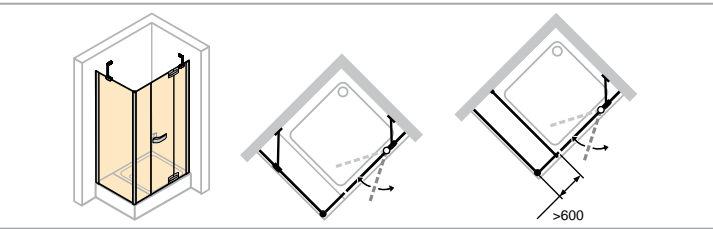

Right-hand fixing

- Price including slopes and cut-outs.
- Chrome look sealing strip.
- Mirror glass (380/381): Please state in your order which segment should be produced with mirror glass. If this is not stated, the entire unit will be produced with mirror glass.
- For technical information, see Profile Colours and Panel Options section.
- Towel rail height can be selected individually and must be specified with the order. If nothing is specified, the towel rail is always delivered middle of glass (height and width).
- Installation of towel rail only possible on side panel.

Dimensions

WL: 31
R: 15
Mx: M+15
MG: 30

WEM = Tray installation dim. (000)
M = installation dimension Centre glass (001)
Please always specify when ordering.

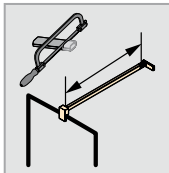
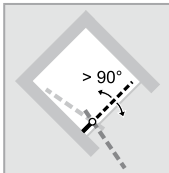
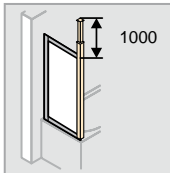
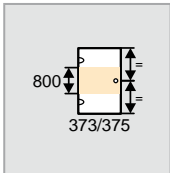
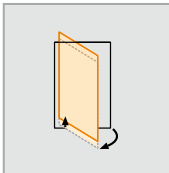
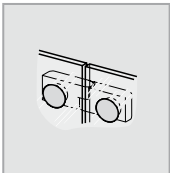
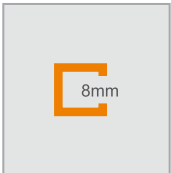

HÜPPE Studio Paris elegance partially framed Rectangular

HÜPPE Studio Berlin pure partially framed Rectangular

Swing door with fixed segment, with additional section and side panel

Made-to-measure - Left-hand fixing

Height	Width Door front	Width Side panel	PARIS	BERLIN	Base price
1200-2000	900-1200	300-1200	PT0189	BT0189	3.537,-
	900-1200	1201-1800	PT018E	BT018E	3.931,-
	1201-3300	300-1200			
2001-2200	1201-3300	1201-1800	PT018F	BT018F	4.324,-
	900-1200	300-1200	PT018G	BT018G	4.230,-
	900-1200	1201-1800	PT018H	BT018H	4.624,-
	1201-3300	300-1200			
	1201-3300	1201-1800	PT018J	BT018J	5.017,-

Adjustment range = dimensions - 5mm / + 5mm

Made-to-measure - Right-hand fixing

Height	Width Door front	Width Side panel	PARIS	BERLIN	Base price
1200-2000	900-1200	300-1200	PT0199	BT0199	3.537,-
	900-1200	1201-1800	PT019E	BT019E	3.931,-
	1201-3300	300-1200			
2001-2200	1201-3300	1201-1800	PT019F	BT019F	4.324,-
	900-1200	300-1200	PT019G	BT019G	4.230,-
	900-1200	1201-1800	PT019H	BT019H	4.624,-
	1201-3300	300-1200			
	1201-3300	1201-1800	PT019J	BT019J	5.017,-

Adjustment range = dimensions - 5mm / + 5mm

Dim. Range: min. - max.

1200-2200	900-3300	300-1800	200-600	max. 900	116-1800

Special options

Optional variants		Extra charges
Bow-shaped handle	708	151,-
Design profile with ceiling connection. Ceiling connection min. 160mm	702	213,-
Bow-shaped handle and ceiling connection	709	364,-
Individual handle from the HÜPPE range (not in brilliant gold and individual galvanised surfaces).	704	130,-
Towel rail (high-gloss silver as standard, towel rail in black for Black Edition systems)	T99	210,-
Towel rail and bow-shaped handle	T08	361,-
Towel rail and ceiling connection. Ceiling connection min. 160mm.	T02	423,-
Towel rail, bow-shaped handle and ceiling connection. Ceiling connection min. 160mm.	T09	574,-
Towel rail and individual handle from the HÜPPE range (not in brilliant gold and individual galvanised surfaces)	T04	340,-

Colours - Panel options

Basic/inlay colours		Colour code	Extra charges
Black Edition		123	342,-
Individual RAL colours		998	606,-
Basic colours	Profile colour	Colour code	Extra charges
Fittings			
High-grade matt chrome	High-grade matt chrome	E	0,-
Chrome	High-gloss silver	C	354,-
Brilliant gold	pearl gold	G	500,-

Inlay colours	Colour code	Extra charges
Brilliant gold	02	0,-
High-grade matt chrome	05	
Black	23	
White	55	
Chrome	91	

Panel options	without Anti-Plaque		with Anti-Plaque	
	Glass code	Extra charges	Glass code	Extra charges
Clear	321	0,-	322	418,-
Karo	311	371,-	312	789,-
Sand Plus	315		316	
Privatima	373		375	
Mirror glass	380	439,-	381	857,-

Further panel options - see chapter intro.

HÜPPE Studio Paris elegance partially framed Rectangular

HÜPPE Studio Berlin pure partially framed Rectangular

HÜPPE Studio Paris elegance

HÜPPE Studio Berlin pure

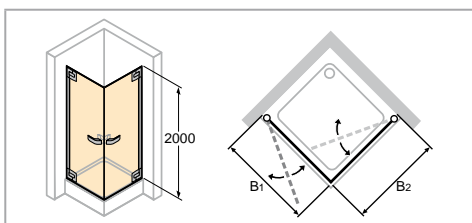
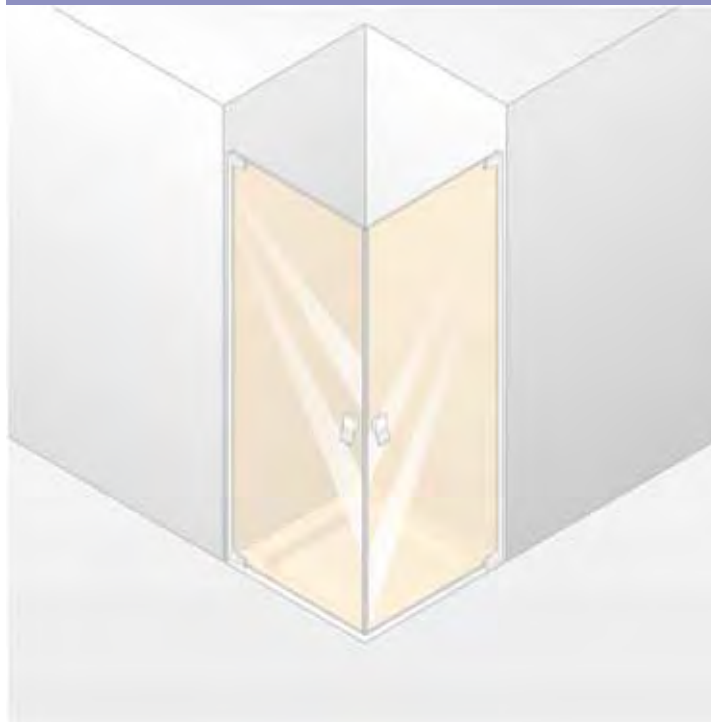

- Chrome look sealing strip.
- Mirror glass (380/381): Please state in your order which segment should be produced with mirror glass. If this is not stated, the entire unit will be produced with mirror glass.
- For technical information, see Profile Colours and Panel Options section.

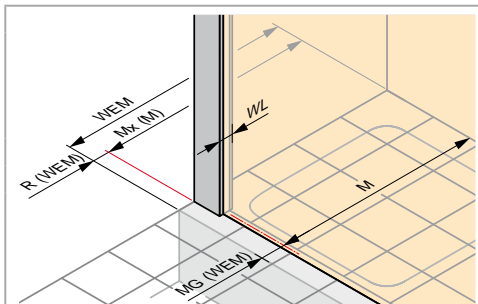

Dimensions

WL: 33
R: 13
Mx: M+17
MG: 30

WEM = Tray installation dim. (000)
M = installation dimension Centre glass (001)
Please always specify when ordering.

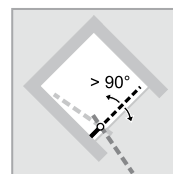
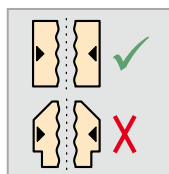
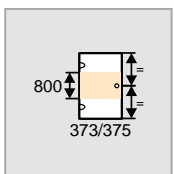
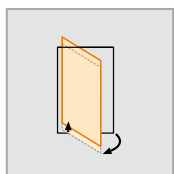
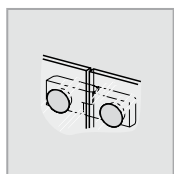
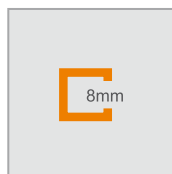

HÜPPE Studio Paris elegance partially framed Rectangular

HÜPPE Studio Berlin pure partially framed Rectangular

Swing door corner entry

Height	Model B1/B2	WEM B1	WEM B2	M (middle of glass) B1	M (middle of glass) B2	Entry width	PARIS	BERLIN	Base price
2000	800x800	790-800	790-800	760-770	760-770	974	PT0301	BT0301	2.693,-
	900x900	890-900	890-900	860-870	860-870	1115	PT0302	BT0302	
	1000x1000	990-1000	990-1000	960-970	960-970	1256	PT0303	BT0303	

Made-to-measure

Height	Width	PARIS	BERLIN	Base price
1200-2000	500-1000	PT0309	BT0309	2.693,-
2001-2200	500-900	PT030E	BT030E	3.385,-

Adjustment range = dimensions - 5mm / + 5mm

Dim. Range: min. - max.

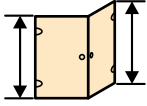
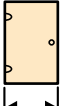
	
1200-2000	500-1000
2001-2200	500-900

Special options

Optional variants		Extra charges
Bow-shaped handle	708	151,-
Individual handle from the HÜPPE range (not in brilliant gold and individual galvanised surfaces).	704	130,-

Colours - Panel options

Basic/inlay colours	Colour code	Extra charges
Black Edition	123	342,-
Individual RAL colours	998	606,-

Basic colours	Profile colour	Colour code	Extra charges
High-grade matt chrome	High-grade matt chrome	E	0,-
Chrome	High-gloss silver	C	354,-
Brilliant gold	pearl gold	G	500,-

Inlay colours	Colour code	Extra charges
Brilliant gold	02	0,-
High-grade matt chrome	05	
Black	23	
White	55	
Chrome	91	

Panel options	without Anti-Plaque		with Anti-Plaque	
	Glass code	Extra charges	Glass code	Extra charges
Clear	321	0,-	322	418,-
Karo	311	371,-	312	789,-
Sand Plus	315		316	
Privatima	373		375	
Mirror glass	380	439,-	381	857,-

Further panel options - see chapter intro.

HÜPPE Studio Paris elegance partially framed Rectangular
HÜPPE Studio Berlin pure partially framed Rectangular

HÜPPE Studio Paris elegance



HÜPPE Studio Berlin pure

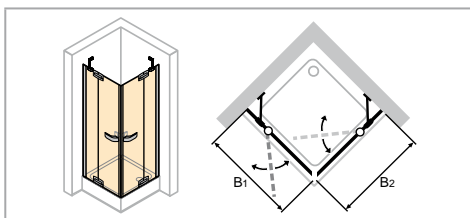
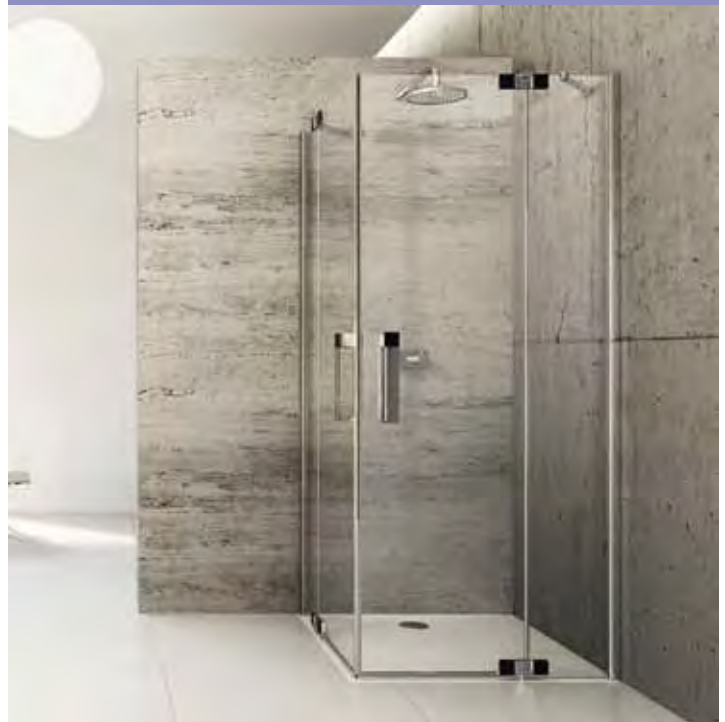

- Price including slopes and cut-outs.
- Chrome look sealing strip.
- Mirror glass (380/381): Please state in your order which segment should be produced with mirror glass. If this is not stated, the entire unit will be produced with mirror glass.
- For technical information, see Profile Colours and Panel Options section.

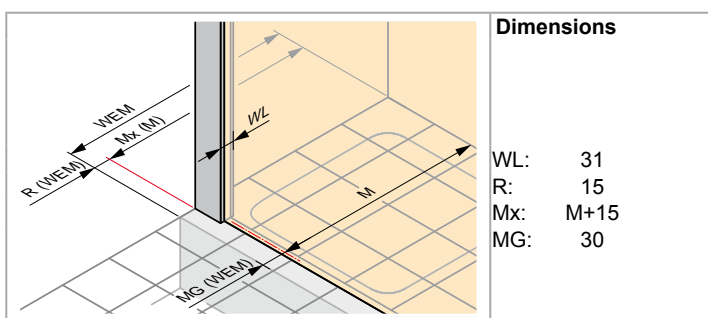

WEM = Tray installation dim. (000)
M = installation dimension Centre glass (001)
Please always specify when ordering.

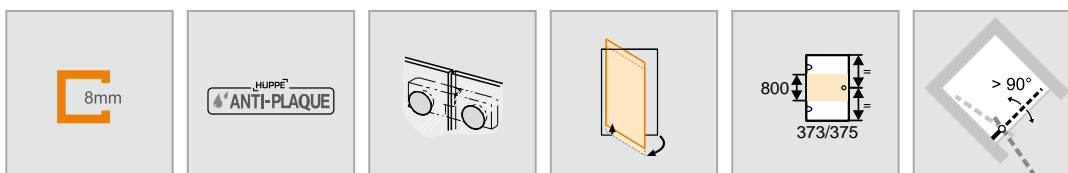

HÜPPE Studio Paris elegance partially framed Rectangular

HÜPPE Studio Berlin pure partially framed Rectangular

Swing door corner entry with fixed segments

Made-to-measure

Height	Width B1/B2	Width of fixed segment	PARIS	BERLIN	Base price
1200-2000	700-1200	200-600	PT0329	BT0329	3.537,-
	1201-1500	200-600	PT032E	BT032E	3.931,-
2001-2200	700-1200	200-600	PT032F	BT032F	4.230,-
	1201-1500	200-600	PT032G	BT032G	4.624,-

Adjustment range = dimensions - 5mm / + 5mm

Dim. Range: min. - max.

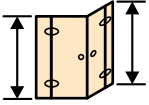
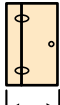
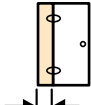
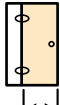
			
1200-2000	700-1500	200-600	max. 1000
2001-2200	700-1500	200-600	max. 900

Special options

Optional variants		Extra charges
Bow-shaped handle	708	151,-
Individual handle from the HÜPPE range (not in brilliant gold and individual galvanised surfaces).	704	130,-

Colours - Panel options

Basic/inlay colours	Colour code	Extra charges
Black Edition	123	342,-
Individual RAL colours	998	606,-

Basic colours	Profile colour	Colour code	Extra charges
Fittings			
High-grade matt chrome	High-grade matt chrome	E	0,-
Chrome	High-gloss silver	C	354,-
Brilliant gold	pearl gold	G	500,-

Inlay colours	Colour code	Extra charges
Brilliant gold	02	0,-
High-grade matt chrome	05	
Black	23	
White	55	
Chrome	91	

Panel options	without Anti-Plaque		with Anti-Plaque	
	Glass code	Extra charges	Glass code	Extra charges
Clear	321	0,-	322	418,-
Karo	311		312	
Sand Plus	315	371,-	316	789,-
Privatima	373		375	
Mirror glass	380	439,-	381	857,-

Further panel options - see chapter intro.

HÜPPE Studio Paris elegance partially framed Quadrant
HÜPPE Studio Berlin pure partially framed Quadrant

HÜPPE Studio Paris elegance



HÜPPE Studio Berlin pure

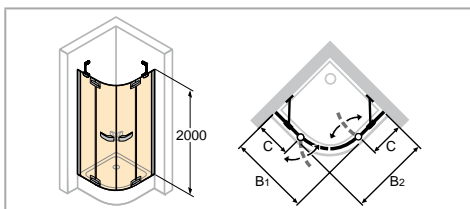
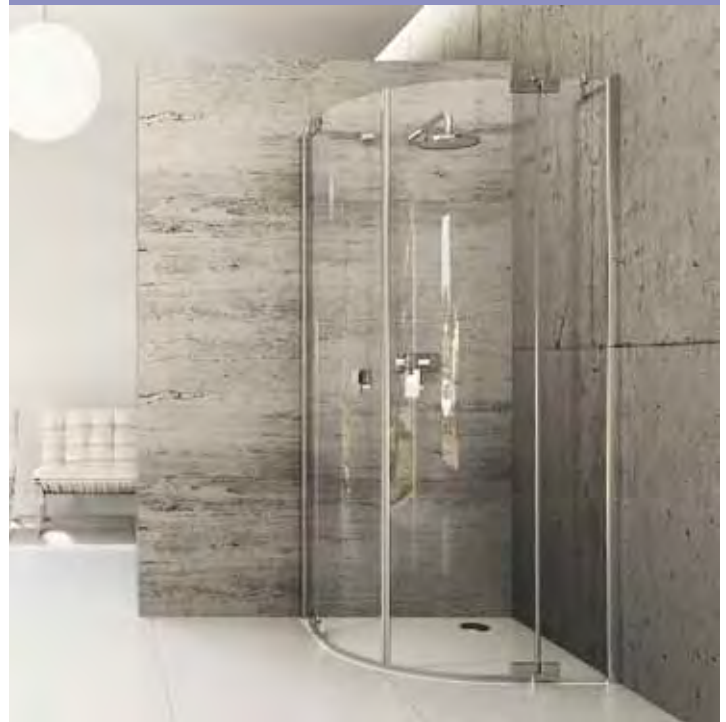

- Price including slopes and cut-outs.
- Chrome look sealing strip.

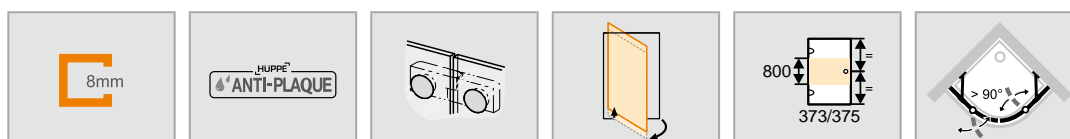
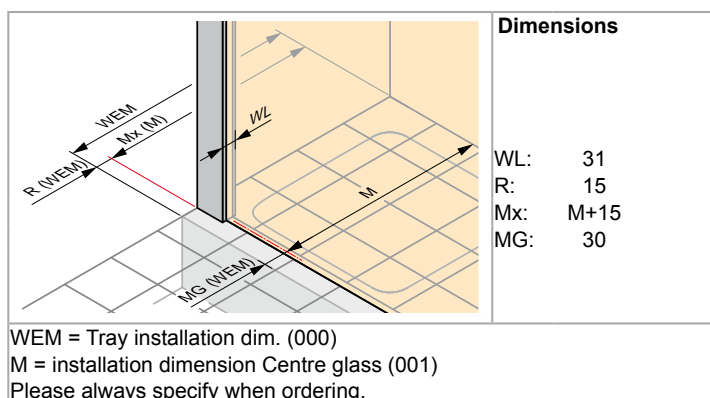

Swing door with fixed segments, 2-panel

Height	Model B1/B2	Pivoting range	WEM	M (middle of glass)	C	Entry width	Radius	PARIS	BERLIN	Base price
2000	900 x 900	470	890-900	860-870	280-290	800	500	PT2320	BT2320	3.537,-
	1000 x 1000	470	990-1000	960-970	380-390	800	500	PT2330	BT2330	
	900 x 900	509	890-900	860-870	230-240	870	550	PT2520	BT2520	
	1000 x 1000	509	990-1000	960-970	330-340	870	550	PT2530	BT2530	

Made-to-measure

Height	Width B1	Width B2	Radius	PARIS	BERLIN	Base price
2000	900-1200	900-1200	500	PT2009	BT2009	3.537,-
	900-1200	900-1200	550	PT2209	BT2209	

Adjustment range = dimensions - 5mm / + 5mm

Dim. Range: min. - max.

2000	200-600	900-1200	900-1200	200-600

Colours - Panel options

Basic/inlay colours		Colour code	Extra charges
Black Edition		123	342,-
Individual RAL colours		998	606,-
Basic colours	Profile colour	Colour code	Extra charges
High-grade matt chrome	High-grade matt chrome	E	0,-
Chrome	High-gloss silver	C	354,-
Brilliant gold	pearl gold	G	500,-
Inlay colours		Colour code	Extra charges
Brilliant gold		02	0,-
High-grade matt chrome		05	
Black		23	
White		55	
Chrome		91	

Panel options	without Anti-Plaque		with Anti-Plaque	
	Glass code	Extra charges	Glass code	Extra charges
Clear	321	0,-	322	418,-
Karo	311	371,-	312	789,-
Sand Plus	315		316	
Privatima	373		375	

Further panel options - see chapter intro.

HÜPPE Studio Paris elegance partially framed Quadrant

HÜPPE Studio Berlin pure partially framed Quadrant

HÜPPE Studio Paris elegance

HÜPPE Studio Berlin pure

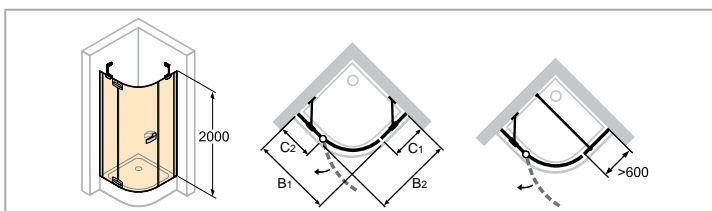
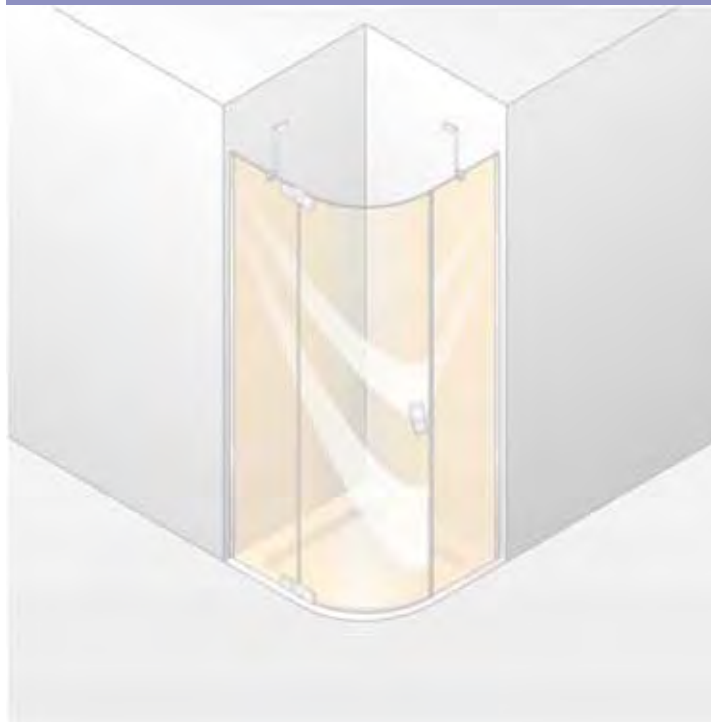
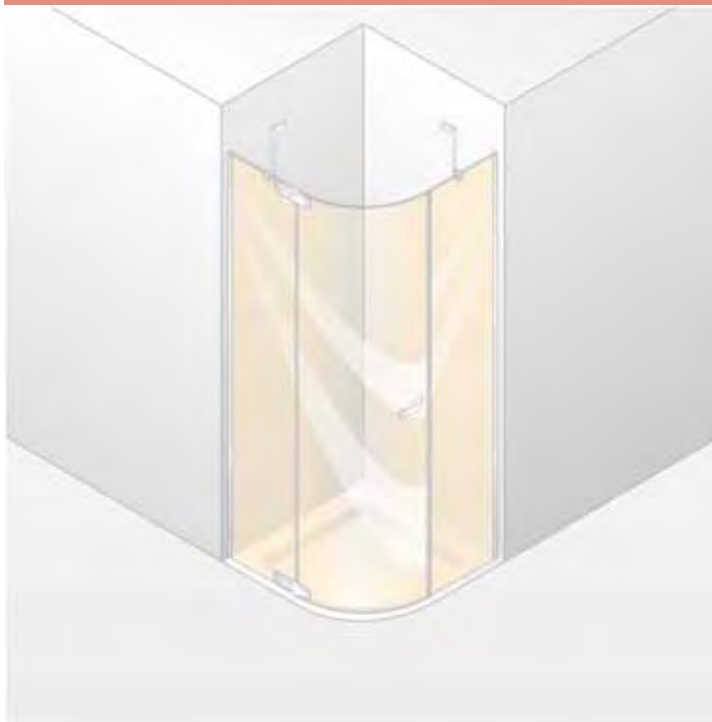

Left-hand fixing

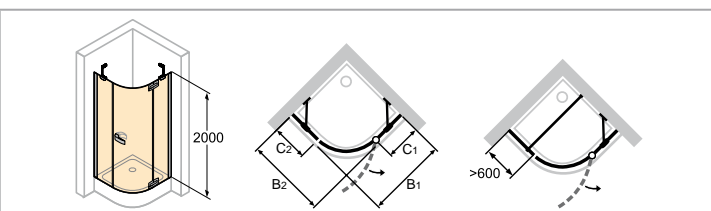

Right-hand fixing

- Price including slopes and cut-outs.
- Chrome look sealing strip.
- The fixed segments on the door side are installed with a tilt of 5mm (at the top) towards the outside.

Dimensions

WL: 31
R: 15
Mx: M+15
MG: 30

WEM = Tray installation dim. (000)
M = installation dimension Centre glass (001)
Please always specify when ordering.

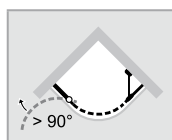
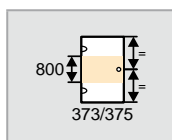
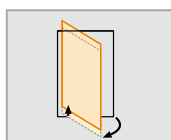
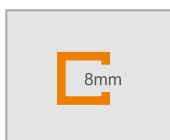

Swing door with fixed segments, 1-panel

Left-hand fixing

Height	Model B1/B2	Pivoting range	WEM	M (middle of glass)	C2	C1	Entry width	Radius	PARIS	BERLIN	Base price
2000	900 x 900	755	890-900	860-870	250-260	390-400	750	500	PT1020	BT1020	3.115,-
	1000 x 1000	755	990-1000	960-970	350-360	490-500	750	500	PT1030	BT1030	
	900 x 900	825	890-900	860-870	202-212	342-352	810	550	PT1220	BT1220	
	1000 x 1000	825	990-1000	960-970	302-312	442-452	810	550	PT1230	BT1230	

Made-to-measure - Left-hand fixing

Height	Width B1	Width B2	Additional section width	Radius	PARIS	BERLIN	Base price
2000	900-1000	900-1000	200-600	500	PT1009	BT1009	3.115,-
	900-1000	900-1000	601-1800	500	PT100E	BT100E	3.508,-
	900-1000	900-1000	200-600	550	PT1209	BT1209	3.115,-
	900-1000	900-1000	601-1800	550	PT120E	BT120E	3.508,-

Adjustment range = dimensions - 5mm / + 5mm

Additional section width > 600mm delivered with cross-bracing

Right-hand fixing

Height	Model B1/B2	Pivoting range	WEM	M (middle of glass)	C2	C1	Entry width	Radius	PARIS	BERLIN	Base price
2000	900 x 900	755	890-900	860-870	390-400	250-260	750	500	PT1520	BT1520	3.115,-
	1000 x 1000	755	990-1000	960-970	490-500	350-360	750	500	PT1530	BT1530	
	900 x 900	825	890-900	860-870	342-352	202-212	810	550	PT1720	BT1720	
	1000 x 1000	825	990-1000	960-970	442-452	302-312	810	550	PT1730	BT1730	

Made-to-measure - Right-hand fixing

Height	Width B1	Width B2	Additional section width	Radius	PARIS	BERLIN	Base price
2000	900-1000	900-1000	200-600	500	PT1509	BT1509	3.115,-
	900-1000	900-1000	601-1800	500	PT150E	BT150E	3.508,-
	900-1000	900-1000	200-600	550	PT1709	BT1709	3.115,-
	900-1000	900-1000	601-1800	550	PT170E	BT170E	3.508,-

Adjustment range = dimensions - 5mm / + 5mm

Additional section width > 600mm delivered with cross-bracing

Dim. Range: min. - max.

2000	200-600	900-1000	900-1000	200-1800

Colours - Panel options

Basic/inlay colours		Colour code	Extra charges
Black Edition		123	342,-
Individual RAL colours		998	606,-
Basic colours	Profile colour	Colour code	Extra charges
High-grade matt chrome	High-grade matt chrome	E	0,-
Chrome	High-gloss silver	C	354,-
Brilliant gold	pearl gold	G	500,-
Inlay colours		Colour code	Extra charges
Brilliant gold		02	0,-
High-grade matt chrome		05	
Black		23	
White		55	
Chrome		91	

Panel options	without Anti-Plaque		with Anti-Plaque	
	Glass code	Extra charges	Glass code	Extra charges
Clear	321	0,-	322	418,-
Karo	311	371,-	312	789,-
Sand Plus	315		316	
Privatima	373		375	

Further panel options - see chapter intro.

HÜPPE Studio Paris elegance partially framed Pentagonal

HÜPPE Studio Berlin pure partially framed Pentagonal

HÜPPE Studio Paris elegance

HÜPPE Studio Berlin pure

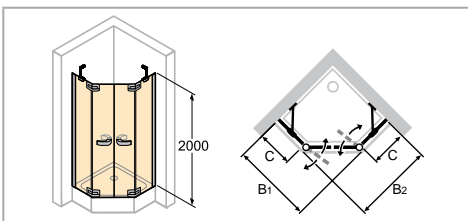
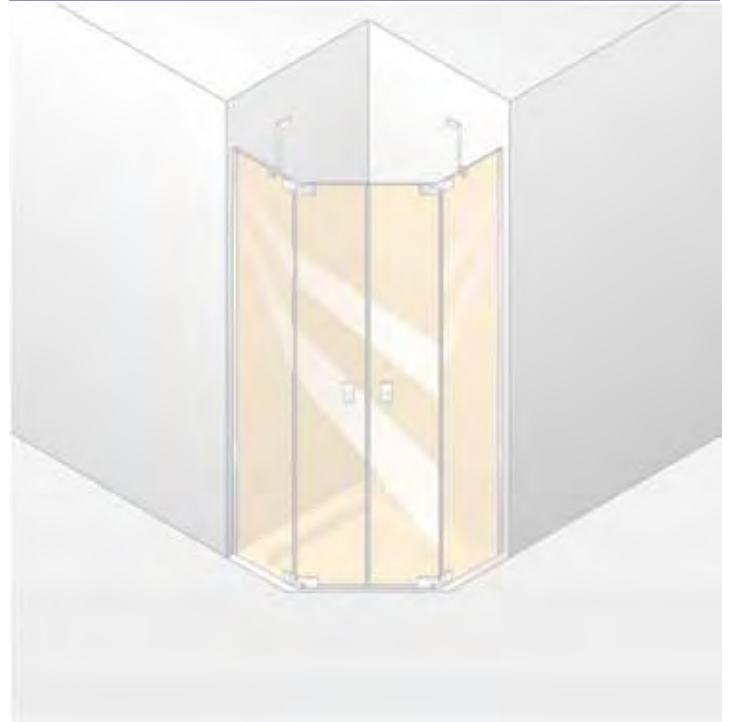
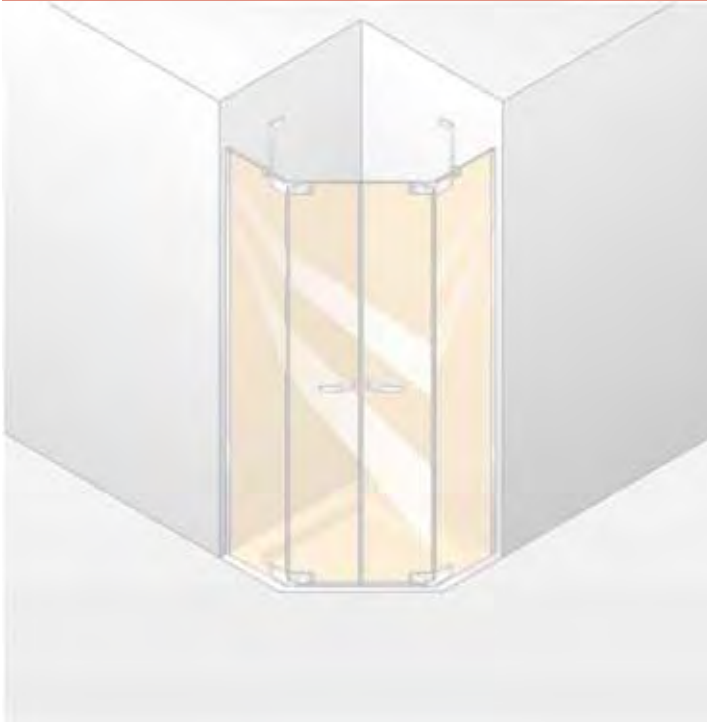

- Price including slopes and cut-outs.
- Chrome look sealing strip.

Dimensions

WL: 31
R: 15
Mx: M+15
MG: 30

WEM = Tray installation dim. (000)
M = installation dimension Centre glass (001)
Please always specify when ordering.

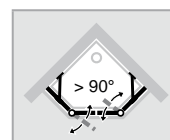
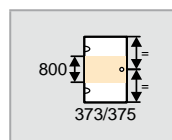
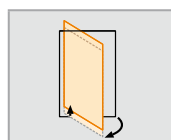
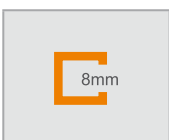

HÜPPE Studio Paris elegance partially framed Pentagonal HÜPPE Studio Berlin pure partially framed Pentagonal

Swing door with fixed segments, 2-panel

Height	Model B1/B2	WEM	M (middle of glass)	Pivoting range	C	Entry width	PARIS	BERLIN	Base price
2000	900 x 900	890-900	860-870	283	441-431	555	PT5020	BT5020	3.537,-
	1000 x 1000	990-1000	960-970	433	491-481	626	PT5030	BT5030	

Made-to-measure

Height	Width B1	Width B2	PARIS	BERLIN	Base price
1200-2000	700-1870	700-1870	PT5009	BT5009	3.537,-
2001-2200	700-1870	700-1870	PT500E	BT500E	4.230,-

Adjustment range = dimensions - 5mm / + 5mm

Dim. Range: min. - max.

1200-2200	200-600	700-1870	700-1870	200-600

Special options

Optional variants		Extra charges
Bow-shaped handle	708	151,-
Individual handle from the HÜPPE range (not in brilliant gold and individual galvanised surfaces).	704	130,-

Colours - Panel options

Basic/inlay colours	Colour code	Extra charges
Black Edition	123	342,-
Individual RAL colours	998	606,-

Basic colours	Profile colour	Colour code	Extra charges
High-grade matt chrome	High-grade matt chrome	E	0,-
Chrome	High-gloss silver	C	354,-
Brilliant gold	pearl gold	G	500,-

Inlay colours	Colour code	Extra charges
Brilliant gold	02	0,-
High-grade matt chrome	05	
Black	23	
White	55	
Chrome	91	

Panel options	without Anti-Plaque		with Anti-Plaque	
	Glass code	Extra charges	Glass code	Extra charges
Clear	321	0,-	322	418,-
Karo	311	371,-	312	789,-
Sand Plus	315		316	
Privatima	373		375	

Further panel options - see chapter intro.

HÜPPE Studio Paris elegance partially framed Pentagonal
HÜPPE Studio Berlin pure partially framed Pentagonal

HÜPPE Studio Paris elegance



HÜPPE Studio Berlin pure

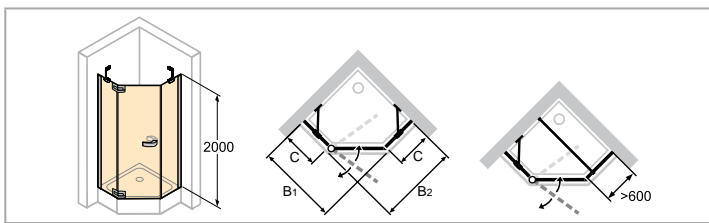

Left-hand fixing

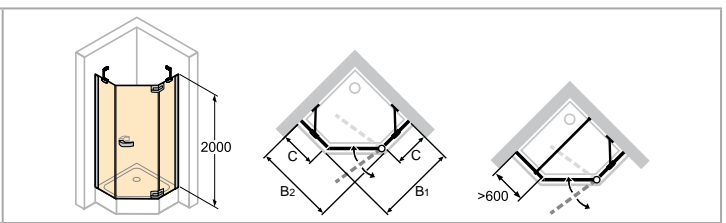

Right-hand fixing

- Price including slopes and cut-outs.
- Chrome look sealing strip.

Dimensions

WL: 31
R: 15
Mx: M+15
MG: 30

WEM = Tray installation dim. (000)
M = installation dimension Centre glass (001)
Please always specify when ordering.

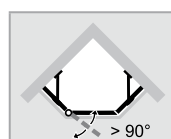
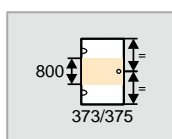
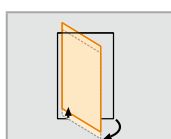
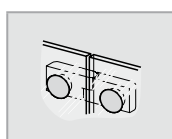
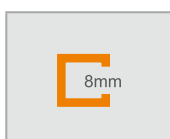

HÜPPE Studio Paris elegance partially framed Pentagonal HÜPPE Studio Berlin pure partially framed Pentagonal

Swing door with fixed segments, 1-panel

Left-hand fixing

Height	Model B1/B2	WEM	M (middle of glass)	Pivoting range	C	Entry width	PARIS	BERLIN	Base price
2000	900 x 900	890-900	860-870	585	441-431	580	PT4020	BT4020	3.115,-
	1000 x 1000	990-1000	960-970	655	491-481	651	PT4030	BT4030	

Made-to-measure - Left-hand fixing

Height	Width B1	Width B2	Additional section width	PARIS	BERLIN	Base price
1200-2000	700-1230	700-2430	116-600	PT4009	BT4009	3.115,-
	700-1230	700-2430	601-1800	PT400E	BT400E	3.508,-
2001-2200	700-1230	700-2430	116-600	PT400F	BT400F	3.807,-
	700-1230	700-2430	601-1800	PT400G	BT400G	4.199,-

Adjustment range = dimensions - 5mm / + 5mm

Additional section width > 600mm delivered with cross-bracing

Right-hand fixing

Height	Model B1/B2	WEM	M (middle of glass)	Pivoting range	C	Entry width	PARIS	BERLIN	Base price
2000	900 x 900	890-900	860-870	585	441-431	580	PT4520	BT4520	3.115,-
	1000 x 1000	990-1000	960-970	655	491-481	651	PT4530	BT4530	

Made-to-measure - Right-hand fixing

Height	Width B1	Width B2	Additional section width	PARIS	BERLIN	Base price
1200-2000	700-1230	700-2430	116-600	PT4509	BT4509	3.115,-
	700-1230	700-2430	601-1800	PT450E	BT450E	3.508,-
2001-2200	700-1230	700-2430	116-600	PT450F	BT450F	3.807,-
	700-1230	700-2430	601-1800	PT450G	BT450G	4.199,-

Adjustment range = dimensions - 5mm / + 5mm

Additional section width > 600mm delivered with cross-bracing

Dim. Range: min. - max.

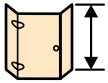
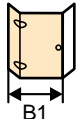
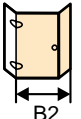
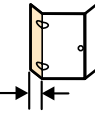
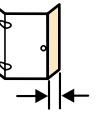
				
1200-2200	700-1230	700-2430	200-600	116-1800

Special options

Optional variants		Extra charges
Bow-shaped handle	708	151,-
Individual handle from the HÜPPE range (not in brilliant gold and individual galvanised surfaces).	704	130,-

Colours - Panel options

Basic/inlay colours	Colour code	Extra charges
Black Edition	123	342,-
Individual RAL colours	998	606,-

Basic colours	Profile colour	Colour code	Extra charges
High-grade matt chrome	High-grade matt chrome	E	0,-
Chrome	High-gloss silver	C	354,-
Brilliant gold	pearl gold	G	500,-

Inlay colours	Colour code	Extra charges
Brilliant gold	02	0,-
High-grade matt chrome	05	
Black	23	
White	55	
Chrome	91	

Panel options	without Anti-Plaque		with Anti-Plaque	
	Glass code	Extra charges	Glass code	Extra charges
Clear	321	0,-	322	418,-
Karo	311	371,-	312	789,-
Sand Plus	315		316	
Privatima	373		375	

Further panel options - see chapter intro.

HÜPPE Walk-In models



HÜPPE Design elegance/ HÜPPE Design pure

Free standing side panel

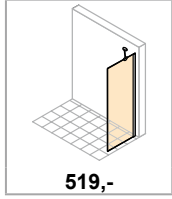

519,-

S.2-S.3

Walk-In side panel with movable segment

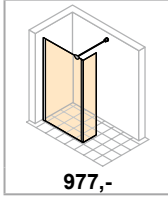

977,-

S.4-S.5

Walk-In side panel with movable segment

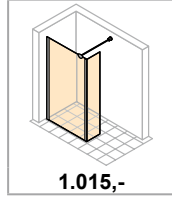

1.015,-

S.6-S.7

HÜPPE Enjoy elegance/HÜPPE Enjoy pure frameless

Free standing side panel

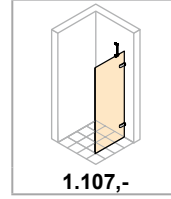

1.107,-

S.8-S.9

Walk-In side panel with movable segment

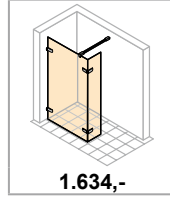

1.634,-

S.10-S.11

HÜPPE Enjoy elegance/HÜPPE Enjoy pure partially framed

Free standing side panel

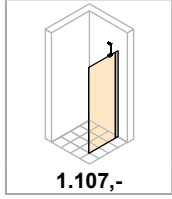

1.107,-

S.12-S.13

Walk-In side panel with movable segment

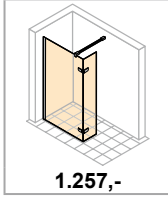

1.257,-

S.14-S.15

HÜPPE Walk-In ConnectPro elegance/ HÜPPE Walk-In ConnectPro pure

Optional segment for Walk-In, fixed

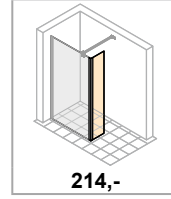

214,-

S.16-S.17

Optional segment for Walk-In, movable

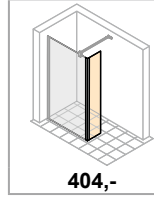

404,-

S.18-S.19

Optional door for Walk-In, movable

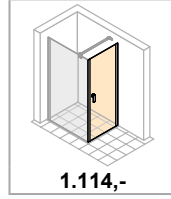

1.114,-

S.20-S.21

HÜPPE Duplo pure

Walk-In

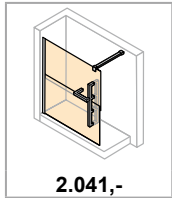

2.041,-

S.22-S.23

HÜPPE Solva pure frameless

Free standing side panel

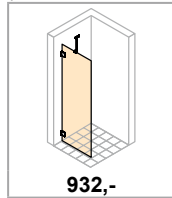

932,-

S.24-S.25

Walk-In side panel with movable segment

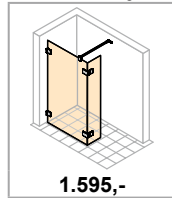

1.595,-

S.26-S.27

HÜPPE Solva pure partially framed

Walk-In side panel with movable segment

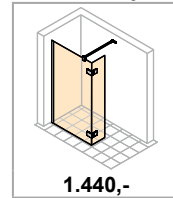

1.440,-

S.28-S.29

HÜPPE Studio Paris elegance frameless HÜPPE Studio Berlin pure frameless

Free standing side panel

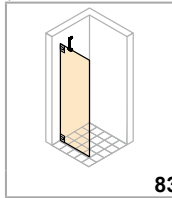

836,-

S.30-S.31

Free-standing side panel

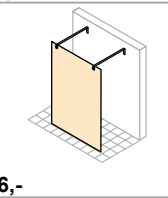

S.32-S.33

Walk-In model 1

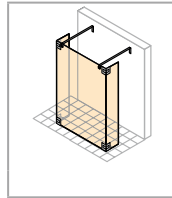

S.34-S.35

Walk-In model 2

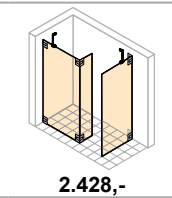

S.36-S.37

Walk-In model 3

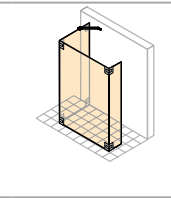

S.38-S.39

Walk-In model 4

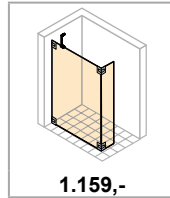

1.159,-

S.40-S.41

HÜPPE Studio Paris elegance partially framed HÜPPE Studio Berlin pure partially framed

Free standing side panel

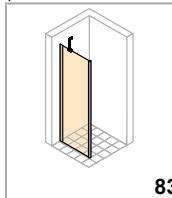

836,-

S.42-S.45

Free-standing side panel

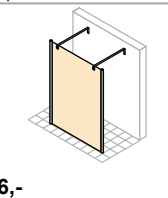

S.46-S.47

Walk-In model 1

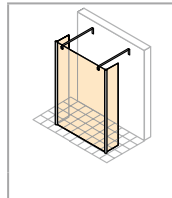

S.48-S.49

Walk-In model 2

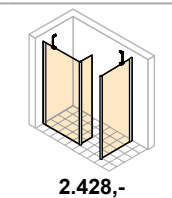

S.50-S.51

Walk-In model 3

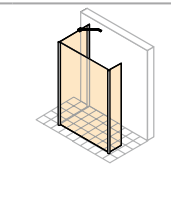

S.52-S.53

Walk-In model 4

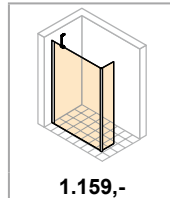

1.159,-

S.54-S.55

HÜPPE Design elegance Rectangular

HÜPPE Design pure Rectangular

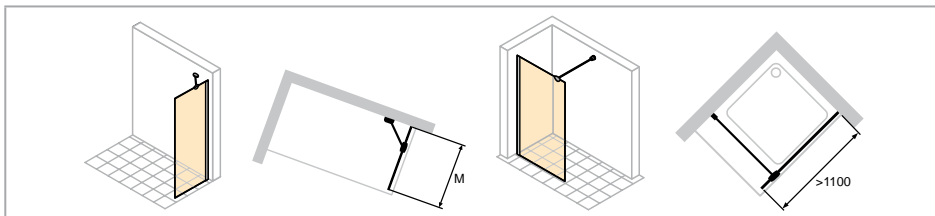
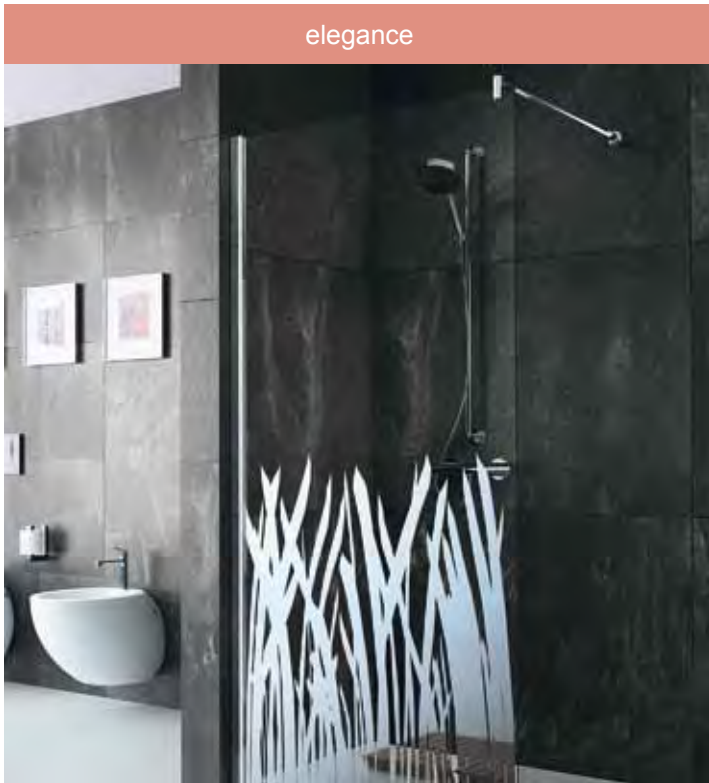

- Can also be combined with Design elegance/pure swing door with fixed segment for Walk-In.
- Chrome decor: no made-to-measure possible. Standard products available up to width 1400mm. Special option towel rail not possible.
- Towel rail height can be selected individually and must be specified with the order. If nothing is specified, the towel rail is always delivered middle of glass (height and width).
- Stabilizer, cross bracing always in silver high-gloss, except with the Black Edition and Metallic Edition.

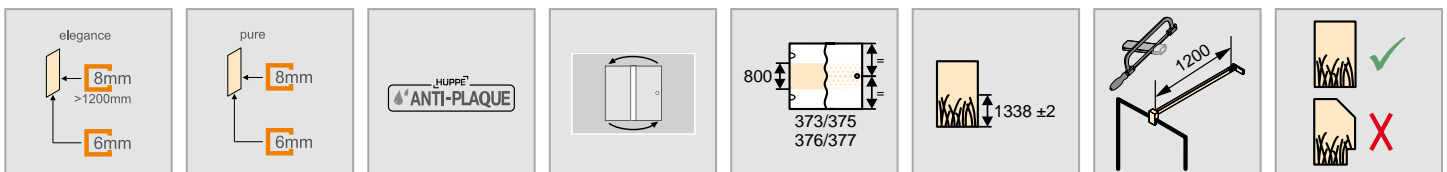
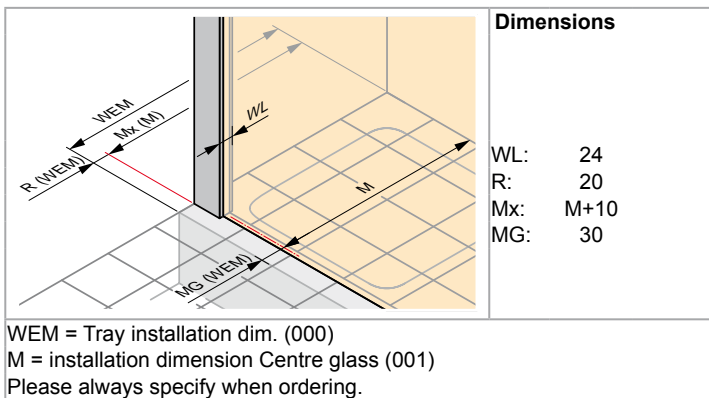

Free standing side panel

Height	Model	Fixing	Width M	Glass thickness	elegance	pure	Base price
2000	SW 750	Stabilizer	735-750	6	8E1112	8P1112	519,-
	SW 800	Stabilizer	785-800	6	8E1101	8P1101	
	SW 900	Stabilizer	885-900	6	8E1102	8P1102	
	SW 1000	Stabilizer	985-1000	6	8E1103	8P1103	536,-
	SW 1100	Stabilizer	1085-1100	6	8E1104	8P1104	
	SW 750	Cross-bracing	735-750	6	8E1113	8P1113	540,-
	SW 800	Cross-bracing	785-800	6	8E1105	8P1105	
	SW 900	Cross-bracing	885-900	6	8E1106	8P1106	
	SW 1000	Cross-bracing	985-1000	6	8E1107	8P1107	557,-
	SW 1100	Cross-bracing	1085-1100	6	8E1108	8P1108	
	SW 1200	Cross-bracing	1185-1200	6	8E1109	8P1109	572,-
	SW 750	Stabilizer	735-750	8		8P1132	
	SW 800	Stabilizer	785-800	8		8P1121	
	SW 900	Stabilizer	885-900	8		8P1122	
	SW 1000	Stabilizer	985-1000	8		8P1123	
	SW 1100	Stabilizer	1085-1100	8		8P1124	
	SW 750	Cross-bracing	735-750	8		8P1133	
	SW 800	Cross-bracing	785-800	8		8P1125	
	SW 900	Cross-bracing	885-900	8		8P1126	
	SW 1000	Cross-bracing	985-1000	8		8P1127	
SW 1100	Cross-bracing	1085-1100	8		8P1128		
SW 1200	Cross-bracing	1185-1200	8		8P1129		
SW 1300	Cross-bracing	1285-1300	8	8E1110	8P1110		
SW 1400	Cross-bracing	1385-1400	8	8E1111	8P1111		
SW 1600	Cross-bracing	1585-1600	8	8E1114	8P1114		

Made-to-measure

Height	Model	Fixing	Width	Glass thickness	elegance	pure	Base price
to 2000	Free standing side panel	Stabilizer	200-1100	6	8E1180	8P1180	675,-
	Free standing side panel	Cross-bracing	200-1200	6	8E1181	8P1181	
	Free standing side panel	Cross-bracing	200-1400	8	8E1182	8P1182	878,-
	Free standing side panel	Cross-bracing	1401-1600	8	8E1183	8P1183	

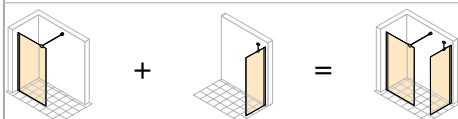

Adjustment range = dimensions - 8mm / + 7mm



Slopes and cut-outs

Slopes and cut-outs	Extra charges
	Supplement per slope/cut-out for made-to-measure 170,-

Dim. Range: min. - max.

	
to 2000	200-1600

Special options

Special options	Extra charges
Towel rail (silver high-gloss, Black Edition)	T99 210,-
Select+ wall profile (colours 087 matt silver, 123 Black Edition, 069 silver high-gloss)	881 202,-

With variants 881 slopes and cut-outs are not possible.

Colours - Panel options

Profile colours	Colour code	Extra charges
White	055	0,-
Matt silver	087	0,-
Silver high-gloss	092	114,-
Black	023	156,-
Grey/brown	061	156,-

HÜPPE Design pure

Profile colours	Colour code	Extra charges
Black Edition	123	171,-
Metallic Edition	138	287,-

Panel options	without Anti-Plaque		with Anti-Plaque	
	Glass code	Extra charges	Glass code	Extra charges
Clear	321	0,-	322	209,-
Grey	301		368	
Bronze	341		378	
Sand Plus	315	186,-	316	395,-
Privatima	373		375	
Bubbles	376		377	
Decor Element glass	372	299,-	389	508,-
Mirror glass	380	657,-	381	866,-

HÜPPE Design elegance Rectangular

HÜPPE Design pure Rectangular

elegance



pure

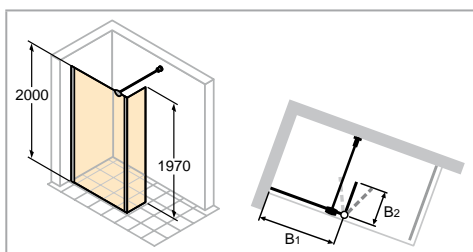

- Can also be combined with Design elegance and pure free-standing side panel.
- Mirror glass (380/381): Please state in your order which segment should be produced with mirror glass. If this is not stated, the entire unit will be produced with mirror glass.
- For technical information, see Profile Colours and Panel Options section.
- Towel rail height can be selected individually and must be specified with the order. If nothing is specified, the towel rail is always delivered middle of glass (height and width).
- Stabilizer, cross bracing, cover cap always in silver high-gloss, except with the Black Edition.

Glass 373/375 Privatima: Specification in the order whether left-hand or right-hand fixing.

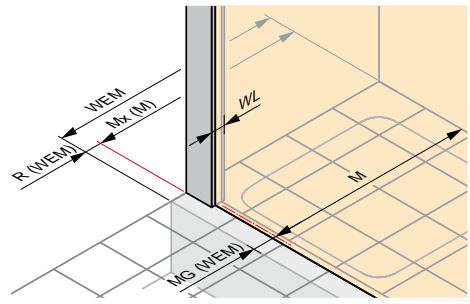

Dimensions

WL: 24
R: 20
Mx: M+10
MG: 30

WEM = Tray installation dim. (000)
M = installation dimension Centre glass (001)
Please always specify when ordering.

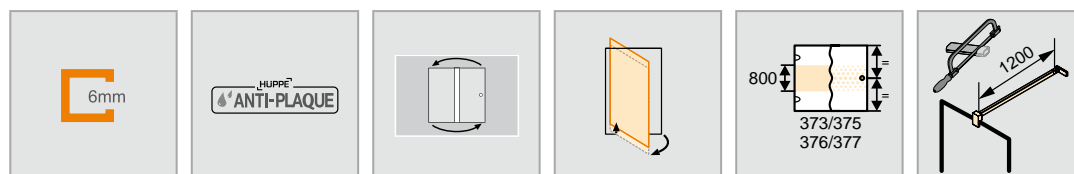

Walk-In side panel with movable segment

Height	WEM fixed segment	From wall to pivot B1	B2	Total width	elegance	pure	Base price
2000	790-805	760-775	356	1116-1131	8E1204	8P1204	977,-
	890-905	860-875	356	1216-1231	8E1205	8P1205	
	990-1005	960-975	356	1316-1331	8E1206	8P1206	
	1190-1205	1160-1175	356	1516-1531	8E1207	8P1207	

Made-to-measure

Height	Total width	Width B1	Width B2	elegance	pure	Base price
1400-2000	550-1800	300-1200	250-600	8E1282	8P1282	1.271,-

Adjustment range = dimensions - 8mm / + 7mm

Width ≤ 600mm with stabilizer, ≥ 601mm with cross bar.

Slopes and cut-outs

Slopes and cut-outs	Extra charges
 Supplement per slope/cut-out for made-to-measure	170,-

Dim. Range: min. - max.

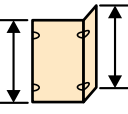
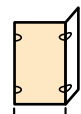
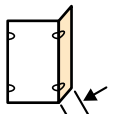
		
1400-2000	300-1200	250-600

Special options

Special options	Extra charges
Towel rail (silver high-gloss, Black Edition)	T99 210,-
Select+ wall profile (colours 087 matt silver, 123 Black Edition, 069 silver high-gloss)	881 202,-

Colours - Panel options

Profile colours	Colour code	Extra charges	Panel options	without Anti-Plaque		with Anti-Plaque		
				Glass code	Extra charges	Glass code	Extra charges	
White	055	0,-	Clear	321	0,-	322	209,-	
Matt silver	087		Grey	301		368		
Black	023		Bronze	341		378		
Grey/brown	061		Sand Plus	315		316		
Silver high-gloss	092		Privatima	373		375		
			Bubbles	376	377			
			Mirror glass	380	439,-	381	648,-	
HÜPPE Design pure								
Profile colours	Colour code	Extra charges						
Black Edition	123	171,-						

HÜPPE 501 Design pure Rectangular

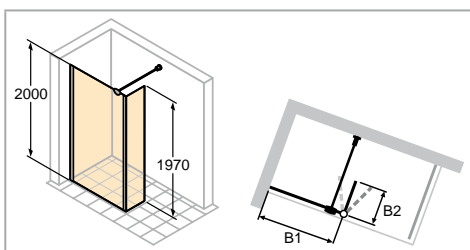

- Can also be combined with Design pure stand-alone side panel.
- Towel rail height can be selected individually and must be specified with the order. If nothing is specified, the towel rail is always delivered middle of glass (height and width).
- Stabilizer, cross bracing, cover cap always in silver high-gloss, except with the Black Edition.

Glass 373/375 Privatima: Specification in the order whether left-hand or right-hand fixing.

Dimensions	
WL:	24
R:	15
Mx:	M+12
MG:	30

WEM = Tray installation dim. (000)
M = installation dimension Centre glass (001)
Please always specify when ordering.

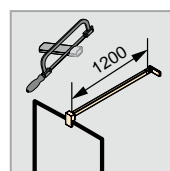
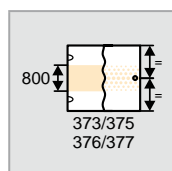
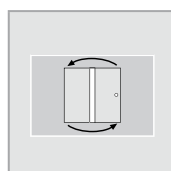
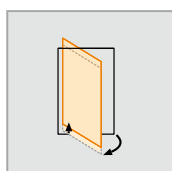
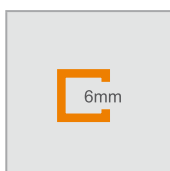

Walk-In side panel with movable segment

Height	WEM fixed segment	From wall to pivot B1	B2	Total width	pure	Base price
2000	790-805	760-775	356	1116-1131	510893	1.015,-
	890-905	860-875	356	1216-1231	510894	
	990-1005	960-975	356	1316-1331	510895	
	1190-1205	1160-1175	356	1516-1531	510896	

Made-to-measure

Height	Total width	Width B1	Width B2	pure	Base price
1400-2000	550-1800	300-1200	250-600	510897	1.320,-

Adjustment range = dimensions - 8mm / + 7mm

Width ≤ 600mm with stabilizer, ≥ 601mm with cross bar.

Slopes and cut-outs

Slopes and cut-outs	Extra charges
	Supplement per slope/cut-out for made-to-measure 170,-

Dim. Range: min. - max.

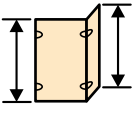
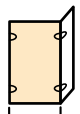
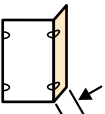
		
1400-2000	300-1200	250-600

Special options

Special options	Extra charges
Towel rail (silver high-gloss)	210,-

Colours - Panel options

Profile colours	Colour code	Extra charges	Panel options	without Anti-Plaque		with Anti-Plaque	
				Glass code	Extra charges	Glass code	Extra charges
White	055	0,-	Clear	321	0,-	322	209,-
Matt silver	087		Grey	301		368	
Black	023	162,-	Bronze	341		378	
Grey/brown	061		Sand Plus	315	186,-	316	395,-
Silver high-gloss	092		Privatima	373		375	
			Bubbles	376		377	

HÜPPE Enjoy elegance frameless Rectangular

HÜPPE Enjoy pure frameless Rectangular

elegance



pure

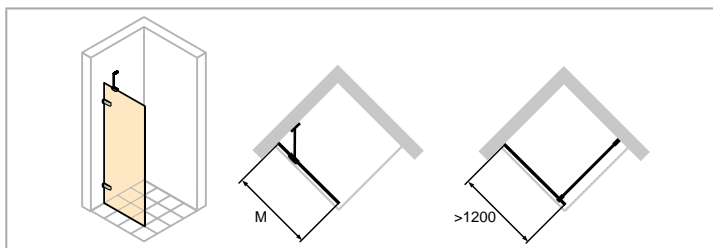

Left-hand fixing

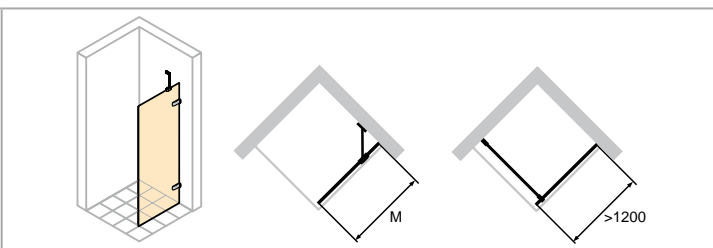

Right-hand fixing

- Measurements must always be taken.
- Towel rail height can be selected individually and must be specified with the order. If nothing is specified, the towel rail is always delivered middle of glass (height and width).

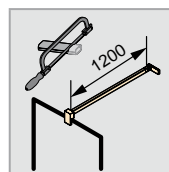
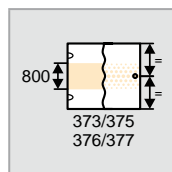
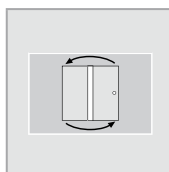
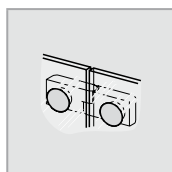
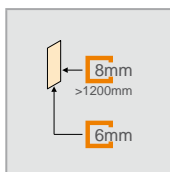

Free standing side panel

Made-to-measure - Left-hand fixing

Height	Fixing	Width M	elegance	pure	Base price
600-2000	Stabilizer	200-1200	3R1180	4R1180	1.107,-
	Cross-bracing	200-1200	3R1183	4R1183	
	Cross-bracing	1201-1600	3R1184	4R1184	1.501,-



Made-to-measure - Right-hand fixing

Height	Fixing	Width M	elegance	pure	Base price
600-2000	Stabilizer	200-1200	3R1280	4R1280	1.107,-
	Cross-bracing	200-1200	3R1283	4R1283	
	Cross-bracing	1201-1600	3R1284	4R1284	1.501,-

Slopes and cut-outs

Slopes and cut-outs	Extra charges
 Supplement per slope/cut-out for made-to-measure	170,-

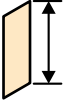
Dim. Range: min. - max.

	
600-2000	200-1600

Special options

Special options	Extra charges
Towel rail (silver high-gloss)	T99 210,-

Colours - Panel options

Profile colours	Colour code	Extra charges	Panel options		without Anti-Plaque		with Anti-Plaque	
			Glass code	Extra charges	Glass code	Extra charges		
Silver high-gloss	092	0,-	Clear	321	0,-	322	209,-	
			Sand Plus	315		316		
			Privatima	373	186,-	375	395,-	
			Bubbles	376		377		
			Mirror glass	380	657,-	381	866,-	

HÜPPE Enjoy elegance frameless Rectangular

HÜPPE Enjoy pure frameless Rectangular

elegance



pure

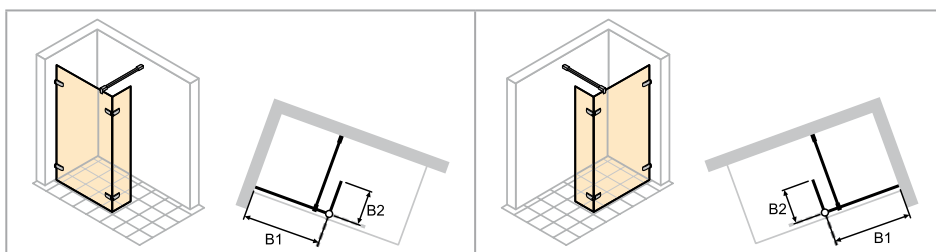

Left-hand fixing

Right-hand fixing

- Measurements must always be taken.
- Tightness only guaranteed at 90 degree position.
- Mirror glass (380/381): Please state in your order which segment should be produced with mirror glass. If this is not stated, the entire unit will be produced with mirror glass.
- For technical information, see Profile Colours and Panel Options section.
- Towel rail height can be selected individually and must be specified with the order. If nothing is specified, the towel rail is always delivered middle of glass (height and width).

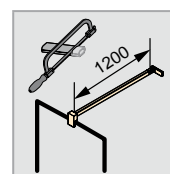
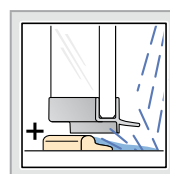
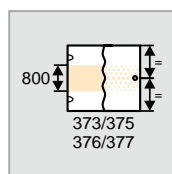
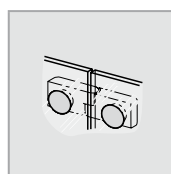
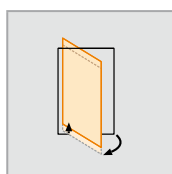
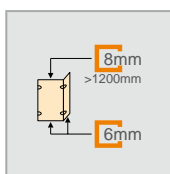

Walk-In side panel with movable segment

Made-to-measure - Left-hand fixing

Height	Fixing	Width B1	Width B2	elegance	pure	Base price
1600-2000	Cross-bracing	300-1200	300-600	3R1380	4R1380	1.634,-
	Cross-bracing	1201-1600	300-600	3R1381	4R1381	2.027,-

Made-to-measure - Right-hand fixing

Height	Fixing	Width B1	Width B2	elegance	pure	Base price
1600-2000	Cross-bracing	300-1200	300-600	3R1480	4R1480	1.634,-
	Cross-bracing	1201-1600	300-600	3R1481	4R1481	2.027,-

Slopes and cut-outs

Slopes and cut-outs	Extra charges
	Supplement per slope/cut-out for made-to-measure 170,-

Dim. Range: min. - max.

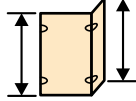
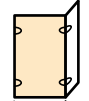
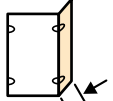
		
1600-2000	300-1600	300-600

Special options

Special options	Extra charges
Towel rail (silver high-gloss)	T99 210,-

Colours - Panel options

Profile colours	Colour code	Extra charges	Panel options	without Anti-Plaque		with Anti-Plaque	
				Glass code	Extra charges	Glass code	Extra charges
Silver high-gloss	092	0,-	Clear	321	0,-	322	209,-
			Sand Plus	315		316	
			Privatima	373	186,-	375	395,-
			Bubbles	376		377	
			Mirror glass	380	439,-	381	648,-

HÜPPE Enjoy elegance partially framed Rectangular

HÜPPE Enjoy pure partially framed Rectangular

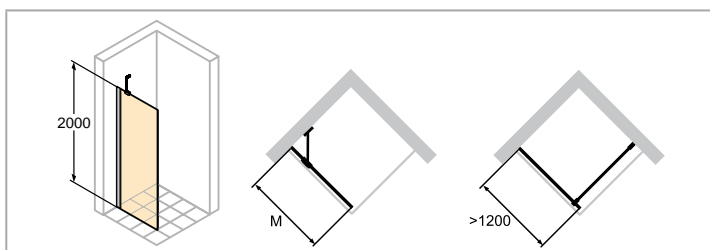
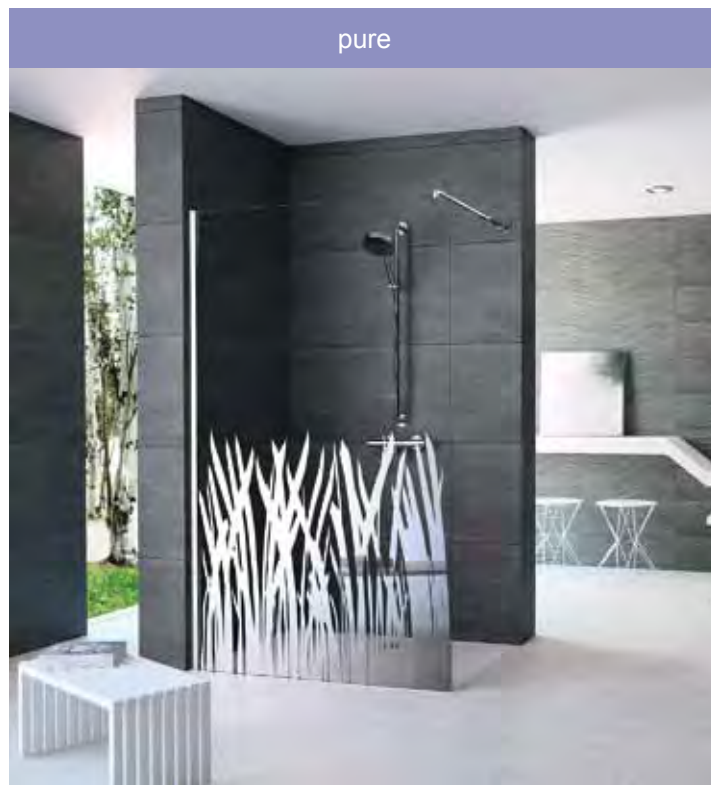

- Chrome decor: no made-to-measure possible. Special option towel rail not possible.
- Towel rail height can be selected individually and must be specified with the order. If nothing is specified, the towel rail is always delivered middle of glass (height and width).

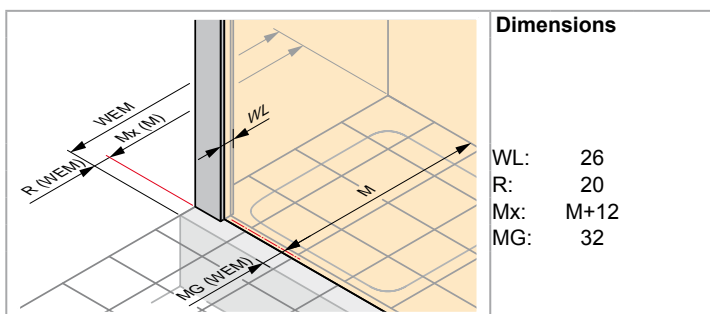

WEM = Tray installation dim. (000)
M = installation dimension Centre glass (001)
Please always specify when ordering.

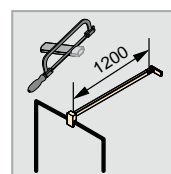
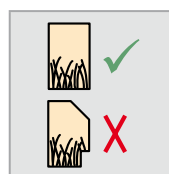
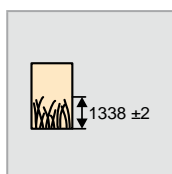
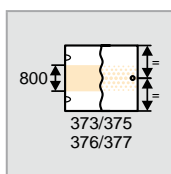
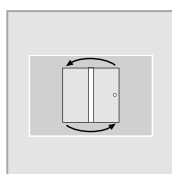
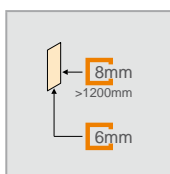

HÜPPE Enjoy elegance partially framed Rectangular

HÜPPE Enjoy pure partially framed Rectangular

Free standing side panel

Height	Model	Fixing	Width M	elegance	pure	Base price
2000	SW 750	Stabilizer	735-755	3T1101	4T1101	1.107,-
	SW 800	Stabilizer	785-805	3T1102	4T1102	
	SW 900	Stabilizer	885-905	3T1103	4T1103	
	SW 1000	Stabilizer	985-1005	3T1104	4T1104	1.153,-
	SW 1100	Stabilizer	1085-1105	3T1105	4T1105	
	SW 750	Cross-bracing	735-755	3T1107	4T1107	1.107,-
	SW 800	Cross-bracing	785-805	3T1108	4T1108	
	SW 900	Cross-bracing	885-905	3T1109	4T1109	
	SW 1000	Cross-bracing	985-1005	3T1110	4T1110	1.153,-
	SW 1100	Cross-bracing	1085-1105	3T1111	4T1111	
	SW 1200	Cross-bracing	1185-1205	3T1106	4T1106	1.173,-
	SW 1300	Cross-bracing	1285-1305	3T1112	4T1112	1.553,-
	SW 1400	Cross-bracing	1385-1405	3T1113	4T1113	

Made-to-measure



Height	Width M	elegance	pure	Base price
600-2000	300-1200	3T1180	4T1180	1.440,-
	1201-1600	3T1181	4T1181	1.833,-

Adjustment range = dimensions - 10mm / + 10mm

Slopes and cut-outs

Slopes and cut-outs	Extra charges
	Supplement per slope/cut-out for made-to-measure 170,-

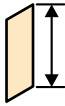
Dim. Range: min. - max.

	
600-2000	300-1600

Special options

Special options	Extra charges
Towel rail (silver high-gloss)	T99 210,-
Select+ wall profile (colours 087 matt silver, 123 Black Edition, 069 silver high-gloss)	881 202,-
With variants 881 slopes and cut-outs are not possible.	

Colours - Panel options

Profile colours	Colour code	Extra charges	Panel options	without Anti-Plaque		with Anti-Plaque	
				Glass code	Extra charges	Glass code	Extra charges
White	055	0,-	Clear	321	0,-	322	209,-
Matt silver	087		Sand Plus	315		316	
Silver high-gloss	092	114,-	Privatima	373	186,-	375	395,-
			Bubbles	376		377	
			Decor Element glass	372	299,-	389	508,-
			Mirror glass	380	657,-	381	866,-

HÜPPE Enjoy elegance partially framed Rectangular

HÜPPE Enjoy pure partially framed Rectangular

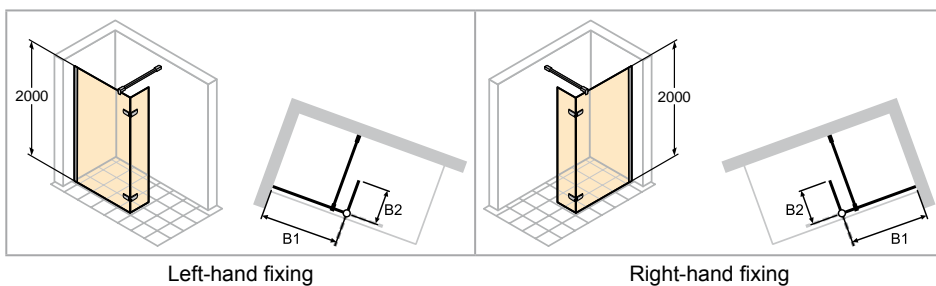
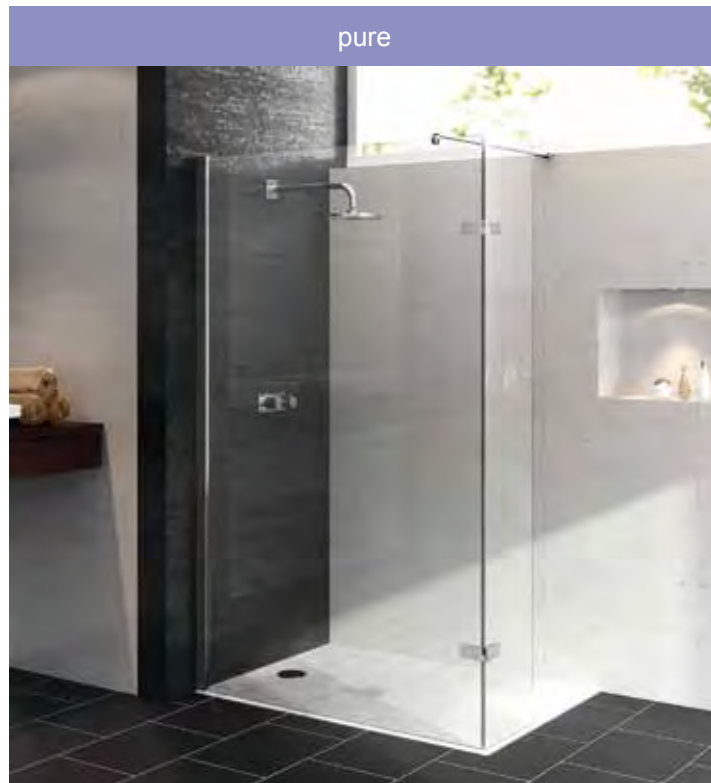

- Tightness only guaranteed at 90 degree position.
- Mirror glass (380/381): Please state in your order which segment should be produced with mirror glass. If this is not stated, the entire unit will be produced with mirror glass.
- For technical information, see Profile Colours and Panel Options section.
- Towel rail height can be selected individually and must be specified with the order. If nothing is specified, the towel rail is always delivered middle of glass (height and width).

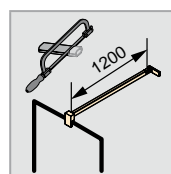
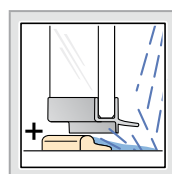
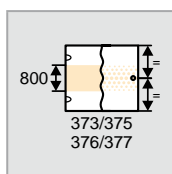
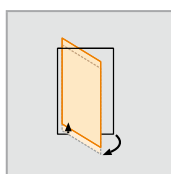
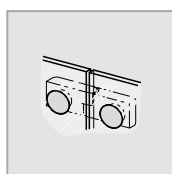
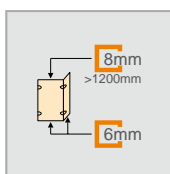
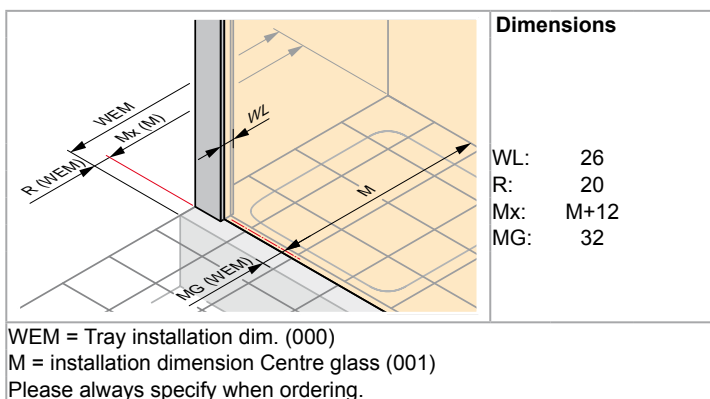

Walk-In side panel with movable segment

Left-hand fixing

Height	WEM fixed segment	B1	B2	Total width	elegance	pure	Base price
2000	785-805	767-787	361	1128-1148	3T1302	4T1302	1.257,-
	885-905	867-887	361	1228-1248	3T1303	4T1303	
	985-1005	967-987	361	1328-1348	3T1304	4T1304	1.310,-
	1185-1205	1167-1187	361	1528-1548	3T1305	4T1305	1.333,-

Made-to-measure - Left-hand fixing

Height	Width B1	Width B2	elegance	pure	Base price
1600-2000	300-1200	361	3T1380	4T1380	1.634,-
	1201-1600	361	3T1381	4T1381	2.027,-

Adjustment range = dimensions - 10mm / + 10mm

Right-hand fixing

Height	WEM fixed segment	B1	B2	Total width	elegance	pure	Base price
2000	785-805	767-787	361	1128-1148	3T1402	4T1402	1.257,-
	885-905	867-887	361	1228-1248	3T1403	4T1403	
	985-1005	967-987	361	1328-1348	3T1404	4T1404	1.310,-
	1185-1205	1167-1187	361	1528-1548	3T1405	4T1405	1.333,-

Made-to-measure - Right-hand fixing

Height	Width B1	Width B2	elegance	pure	Base price
1600-2000	300-1200	361	3T1480	4T1480	1.634,-
	1201-1600	361	3T1481	4T1481	2.027,-

Adjustment range = dimensions - 10mm / + 10mm

Slopes and cut-outs

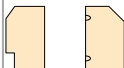
Slopes and cut-outs	Extra charges
	Supplement per slope/cut-out for made-to-measure 170,-

Dim. Range: min. - max.

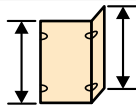
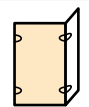
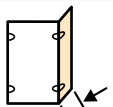
		
1600-2000	300-1600	361

Special options

Special options	Extra charges
Towel rail (silver high-gloss)	T99 210,-

Colours - Panel options

Profile colours	Colour code	Extra charges	Panel options	without Anti-Plaque		with Anti-Plaque	
				Glass code	Extra charges	Glass code	Extra charges
White	055	0,-	Clear	321	0,-	322	209,-
Matt silver	087		Sand Plus	315		316	
Silver high-gloss	092		Privatima	373	186,-	375	395,-
			Bubbles	376		377	
			Mirror glass	380	439,-	381	648,-

HÜPPE Walk-In ConnectPro elegance
HÜPPE Walk-In ConnectPro pure

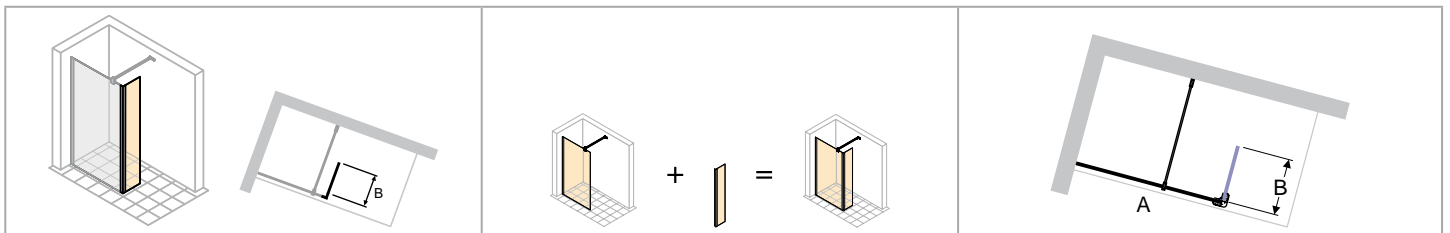

HÜPPE Walk-In ConnectPro
Fixed panel

A = Walk-In model
B = Glass panel width

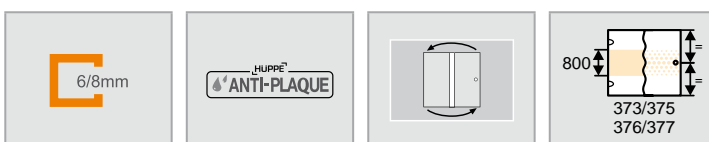

- Optional fixed segment for subsequent installation with Walk-In models.



Optional segment for Walk-In, fixed

Height	Glass thickness	Glass panel B width	elegance	pure	Base price
2000	6	350	CE0001	CP0001	214,-
	8	350	CE0002	CP0002	248,-

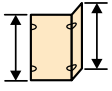
Dim. Range: min. - max.

	
2000	350

Colours - Panel options

Profile colours	Colour code	Extra charges
Matt silver	087	0,-
Silver high-gloss	092	

Panel options	without Anti-Plaque		with Anti-Plaque	
	Glass code	Extra charges	Glass code	Extra charges
Clear	321	0,-	322	209,-
Grey	301	186,-	368	395,-
Bronze	341		378	
Sand Plus	315		316	
Privatima	373		375	
Bubbles	376		377	
Mirror glass	380	439,-	381	648,-

HÜPPE Walk-In ConnectPro elegance
HÜPPE Walk-In ConnectPro pure

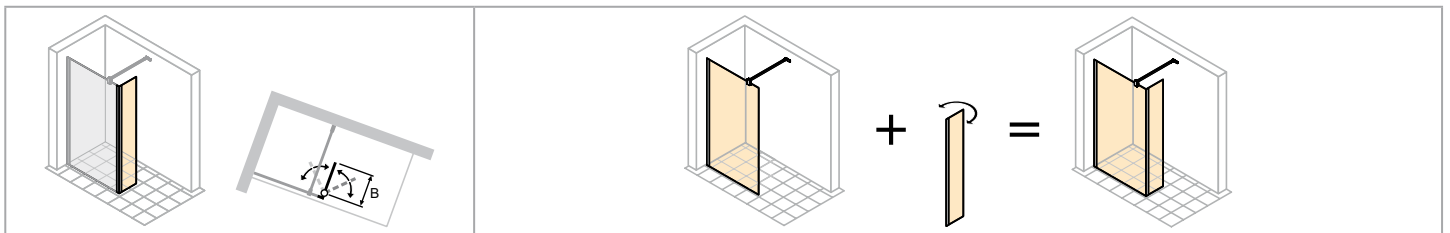

HÜPPE Walk-In ConnectPro
 Movable segment

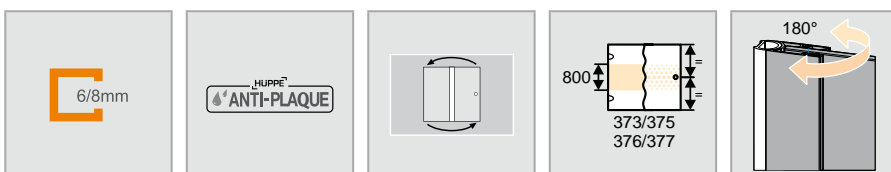

- Optional movable segment for subsequent installation with Walk-In models.



Optional segment for Walk-In, movable

Height	Glass thickness	Glass panel B width	elegance	pure	Base price
2000	6	350	CE0011	CP0011	404,-
	8	350	CE0012	CP0012	509,-

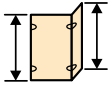
Dim. Range: min. - max.

	
2000	350

Colours - Panel options

Profile colours	Colour code	Extra charges
Matt silver	087	0,-
Silver high-gloss	092	

Panel options	without Anti-Plaque		with Anti-Plaque	
	Glass code	Extra charges	Glass code	Extra charges
Clear	321	0,-	322	209,-
Grey	301	186,-	368	395,-
Bronze	341		378	
Sand Plus	315		316	
Privatima	373		375	
Bubbles	376		377	
Mirror glass	380	439,-	381	648,-

HÜPPE Walk-In ConnectPro elegance

HÜPPE Walk-In ConnectPro pure

elegance

pure

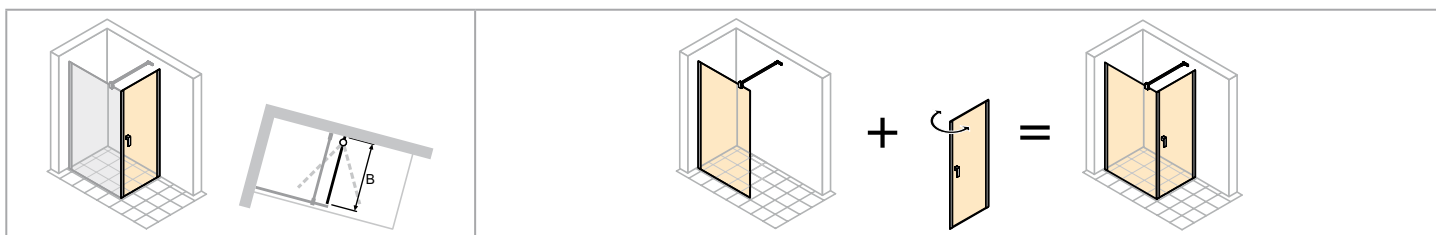
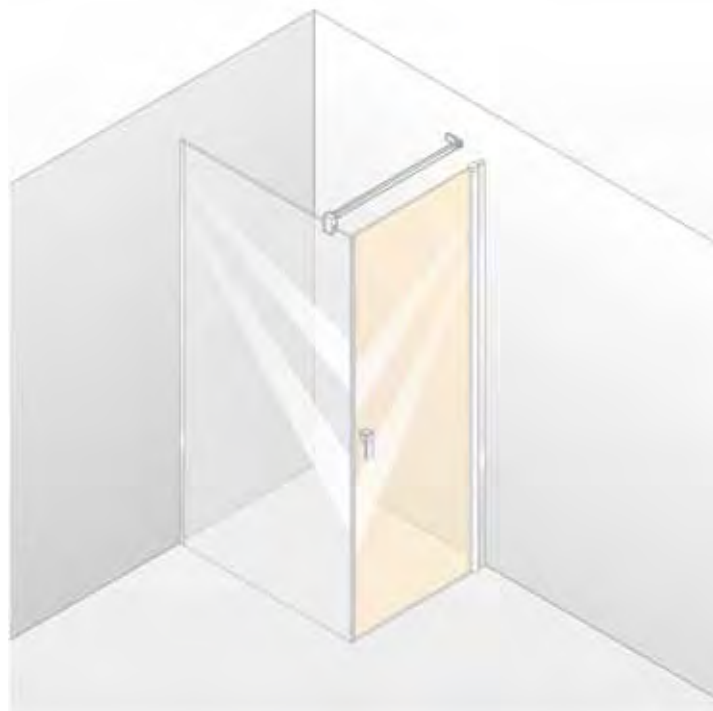
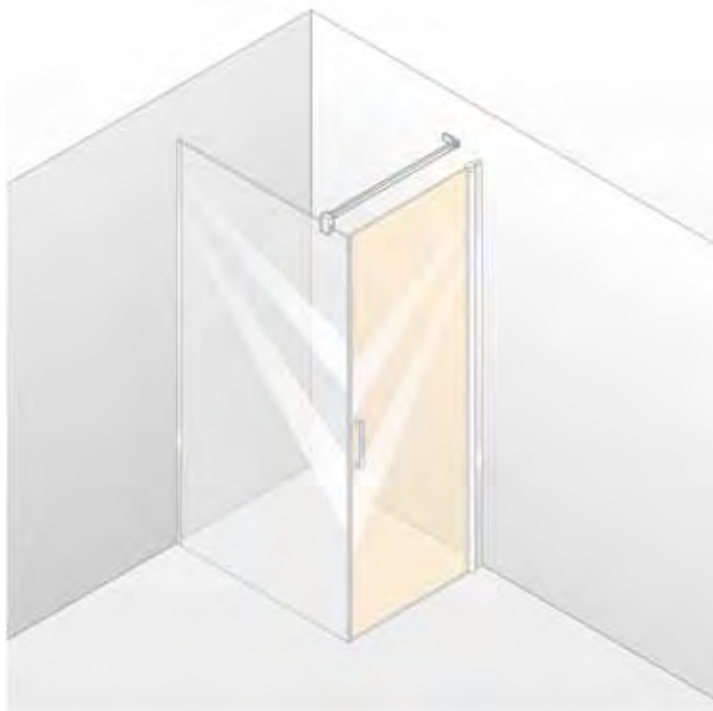

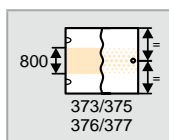
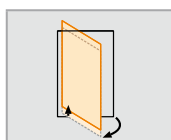
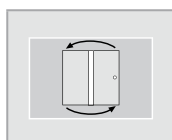
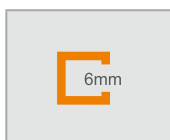

HÜPPE Walk-In ConnectPro
Door

- Optional door for subsequently enclosing Walk-In models.
- Measurements must always be taken.





Optional door for Walk-In, movable

Made-to-measure

Height			elegance	pure	Base price
2000	HÜPPE swing door (Design series) for a complete enclosure of the shower area		CE0180	CP0180	1.114,-
	HÜPPE swing door with fixed segment (Design series) for a complete enclosure of the shower area		CE0280	CP0280	

Dim. Range: min. - max.

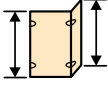
		
500-1100	700-1550	1400-2000

Colours - Panel options

Profile colours	Colour code	Extra charges
Matt silver	087	0,-
Silver high-gloss	092	

Panel options	without Anti-Plaque		with Anti-Plaque	
	Glass code	Extra charges	Glass code	Extra charges
Clear	321	0,-	322	209,-
Grey	301	186,-	368	395,-
Bronze	341		378	
Sand Plus	315		316	
Privatima	373		375	
Bubbles	376		377	
Mirror glass	380	439,-	381	648,-

HÜPPE Duplo pure Rectangular

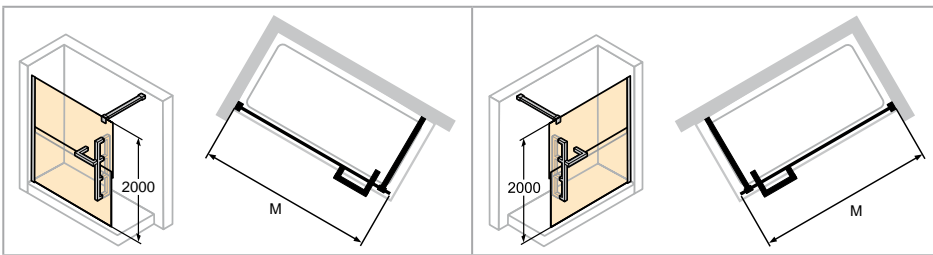

Left-hand fixing

Right-hand fixing

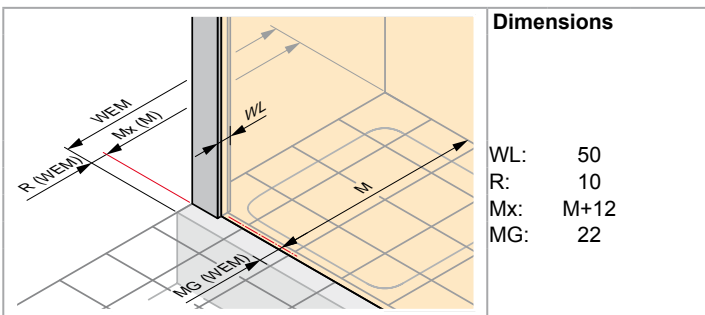

Dimensions

- WL: 50
- R: 10
- Mx: M+12
- MG: 22

WEM = Tray installation dim. (000)
 M = installation dimension Centre glass (001)
 Please always specify when ordering.

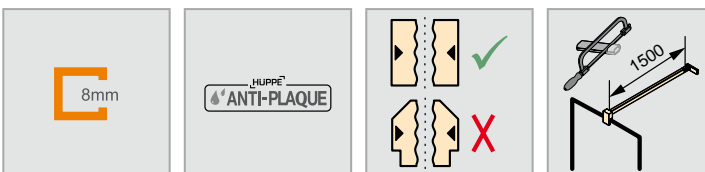

Walk-In

Left-hand fixing

Height	Model	Width	Product no.	Base price
2000	1000	985-1000	DT0000	2.041,-
	1100	1085-1100	DT0001	
	1200	1185-1200	DT0002	2.081,-
	1300	1285-1300	DT0003	2.321,-
	1400	1385-1400	DT0004	
	1600	1585-1600	DT0005	2.741,-
1800	1785-1800	DT0006		

Made-to-measure - Left-hand fixing

Height	Width	Product no.	Base price
1000-2000	1000-1200	DT0029	2.041,-
	1201-1400	DT0049	2.274,-
	1401-1800	DT0009	2.689,-
	1801-2000	DT0069	3.082,-

Adjustment range = dimensions - 8mm / + 7mm

Right-hand fixing

Height	Model	Width	Product no.	Base price
2000	1000	985-1000	DT0010	2.041,-
	1100	1085-1100	DT0011	
	1200	1185-1200	DT0012	2.081,-
	1300	1285-1300	DT0013	2.321,-
	1400	1385-1400	DT0014	
	1600	1585-1600	DT0015	2.741,-
1800	1785-1800	DT0016		

Made-to-measure - Right-hand fixing

Height	Width	Product no.	Base price
1000-2000	1000-1200	DT0039	2.041,-
	1201-1400	DT0059	2.274,-
	1401-1800	DT0019	2.689,-
	1801-2000	DT0079	3.082,-

Adjustment range = dimensions - 8mm / + 7mm

Dim. Range: min. - max.

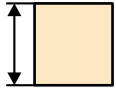
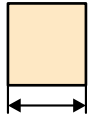
	
1000-2000	1000-2000

Extras

		Product no.	Price
	Soap dish		DT0099 251,-

Colours - Panel options

Profile colours	Colour code	Extra charges	Panel options		without Anti-Plaque		with Anti-Plaque	
					Glass code	Extra charges	Glass code	Extra charges
Chrome/chrome	C91	0,-	Clear	321	0,-	322	209,-	
			Karo	311	186,-	312	395,-	
			Grey	301		368		
			Combi-decor Sandplus	317		318		
			Sand Plus	315		316		

HÜPPE Solva pure frameless Rectangular



Left-hand fixing

Right-hand fixing

- Measurements must always be taken.
- Towel rail height can be selected individually and must be specified with the order. If nothing is specified, the towel rail is always delivered middle of glass (height and width).

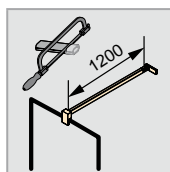
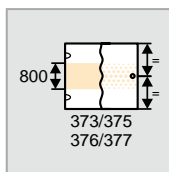
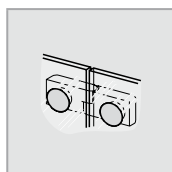
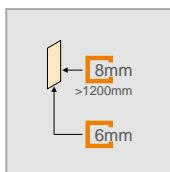

Free standing side panel



Made-to-measure

Height	Fixing	Width	Left-hand fixing Product no.	Right-hand fixing Product no.	Base price
600-2000	Stabilizer	200-1200	SR0180	SR0280	932,-
2001-2200	Stabilizer	200-1200	SR0181	SR0281	1.479,-
600-2000	Cross-bracing	200-1200	SR0182	SR0282	932,-
	Cross-bracing	1201-1800	SR0184	SR0284	1.589,-
2001-2200	Cross-bracing	200-1200	SR0183	SR0283	1.479,-
	Cross-bracing	1201-1800	SR0185	SR0285	2.135,-

Slopes and cut-outs

Slopes and cut-outs	Extra charges
 Supplement per slope/cut-out for made-to-measure	170,-

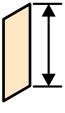
Dim. Range: min. - max.

	
600-2200	220-1800

Special options

Special options	Extra charges
Towel rail (silver high-gloss)	210,-

Colours - Panel options

Profile colours	Colour code	Extra charges	Panel options		without Anti-Plaque		with Anti-Plaque	
			Glass code	Extra charges	Glass code	Extra charges		
Silver high-gloss	092	0,-	Clear	321	0,-	322	209,-	
			Grey	301		368		
			Bronze	341	186,-	378	395,-	
			Sand Plus	315		316		
			Privatima	373		375		
			Bubbles	376		377		
			Mirror glass	380	657,-	381	866,-	

HÜPPE Solva pure frameless Rectangular

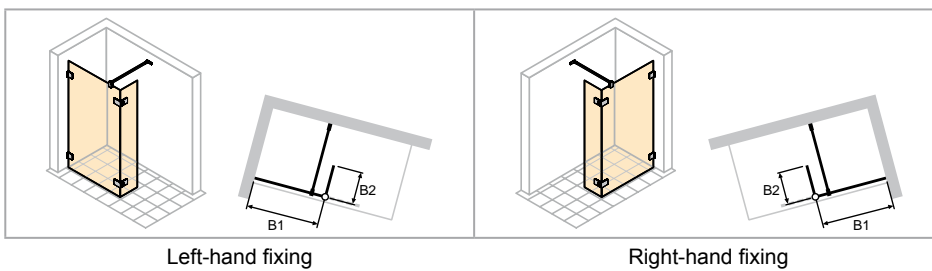

- Measurements must always be taken.
- Mirror glass (380/381): Please state in your order which segment should be produced with mirror glass. If this is not stated, the entire unit will be produced with mirror glass.
- For technical information, see Profile Colours and Panel Options section.
- Towel rail height can be selected individually and must be specified with the order. If nothing is specified, the towel rail is always delivered middle of glass (height and width).
- Tightness only guaranteed at 90 degree position.

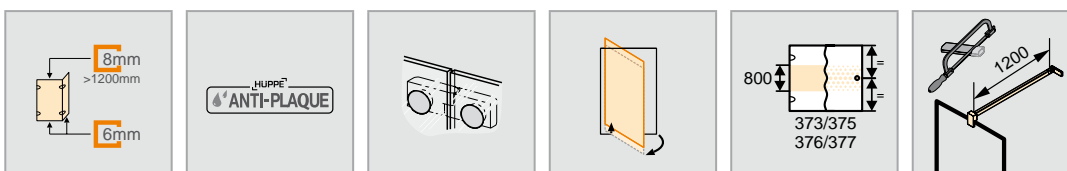

Walk-In side panel with movable segment

Made-to-measure

Height	Width B1	Width B2	Left-hand fixing Product no.	Right-hand fixing Product no.	Base price
1200-2000	200-1200	300-600	SR3680	SR3780	1.595,-
	1201-1800	300-600	SR3682	SR3782	2.251,-
2001-2200	200-1200	300-600	SR3681	SR3781	2.141,-
	1201-1800	300-600	SR3683	SR3783	2.798,-

Slopes and cut-outs

Slopes and cut-outs	Extra charges
	Supplement per slope/cut-out for made-to-measure 170,-

Dim. Range: min. - max.

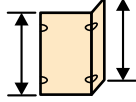
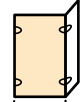
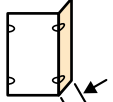
		
1200-2200	220-1800	300-600

Special options

Special options	Extra charges
Towel rail (silver high-gloss)	210,-

Colours - Panel options

Profile colours	Colour code	Extra charges	Panel options	without Anti-Plaque		with Anti-Plaque	
				Glass code	Extra charges	Glass code	Extra charges
Silver high-gloss	092	0,-	Clear	321	0,-	322	209,-
			Grey	301		368	
			Bronze	341		378	
			Sand Plus	315	186,-	316	395,-
			Privatima	373		375	
			Bubbles	376		377	
			Mirror glass	380	439,-	381	648,-

HÜPPE Solva pure partially framed Rectangular

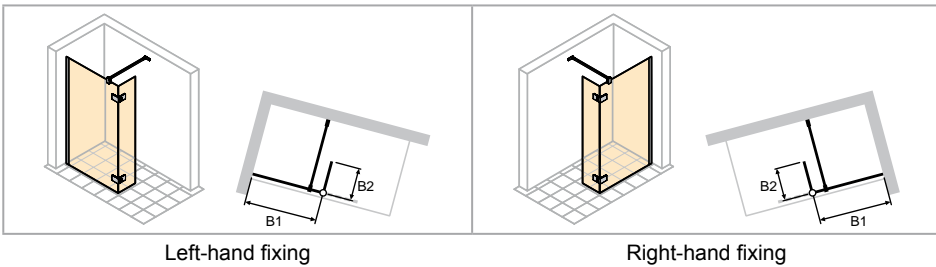

- Mirror glass (380/381): Please state in your order which segment should be produced with mirror glass. If this is not stated, the entire unit will be produced with mirror glass.
- For technical information, see Profile Colours and Panel Options section.
- Towel rail height can be selected individually and must be specified with the order. If nothing is specified, the towel rail is always delivered middle of glass (height and width).
- Tightness only guaranteed at 90 degree position.

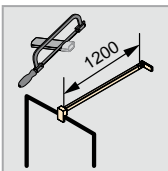
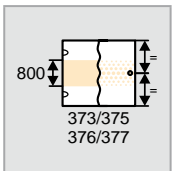
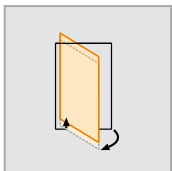
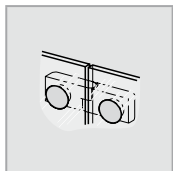
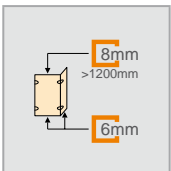
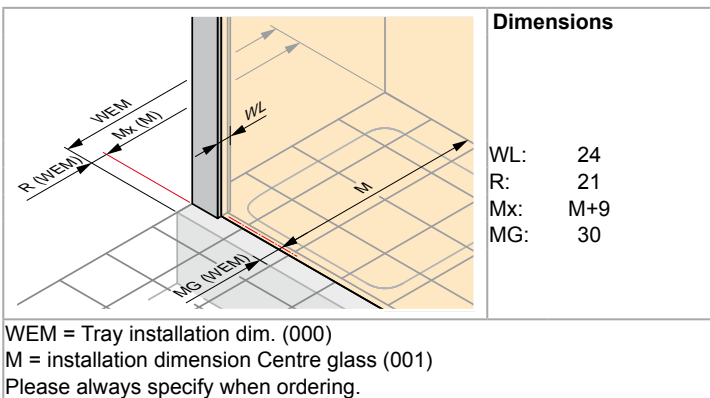

Walk-In side panel with movable segment

Height	Model	Width B1	Width B2	Left-hand fixing Product no.	Right-hand fixing Product no.	Base price
2000	SW 800	790-805	300	ST3601	ST3701	1.440,-
	SW 900	890-905	300	ST3602	ST3702	
	SW 1000	990-1005	300	ST3603	ST3703	1.513,-
	SW 1200	1190-1205	300	ST3604	ST3704	1.541,-
	SW 1300	1290-1305	300	ST3605	ST3705	1.612,-
	SW 1400	1390-1405	300	ST3606	ST3706	

Adjustment range = dimensions - 8mm / + 7mm

Made-to-measure

Height	Width B1	Width B2	Left-hand fixing Product no.	Right-hand fixing Product no.	Base price
1200-2000	200-1200	300-600	ST3680	ST3780	1.595,-
	1201-1800	300-600	ST3682	ST3782	2.251,-
2001-2200	200-1200	300-600	ST3681	ST3781	2.141,-
	1201-1800	300-600	ST3683	ST3783	2.798,-

Slopes and cut-outs

Slopes and cut-outs	Extra charges
	Supplement per slope/cut-out for made-to-measure 170,-

Dim. Range: min. - max.

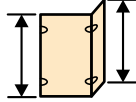
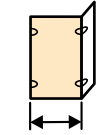
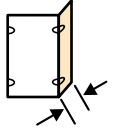
		
1200-2200	200-1800	300-600

Special options

Optional variants	Extra charges
Towel rail (silver high-gloss)	T99 210,-

Colours - Panel options

Profile colours	Colour code	Extra charges	Panel options		without Anti-Plaque		with Anti-Plaque	
			Glass code	Extra charges	Glass code	Extra charges		
Silver high-gloss	092	0,-	Clear	321	0,-	322	209,-	
			Grey	301		368		
			Bronze	341	186,-	378	395,-	
			Sand Plus	315		316		
			Privatima	373		375		
			Bubbles	376		377		
			Mirror glass	380	439,-	381	648,-	

HÜPPE Studio Paris elegance frameless Rectangular

HÜPPE Studio Berlin pure frameless Rectangular

HÜPPE Studio Paris elegance



HÜPPE Studio Berlin pure

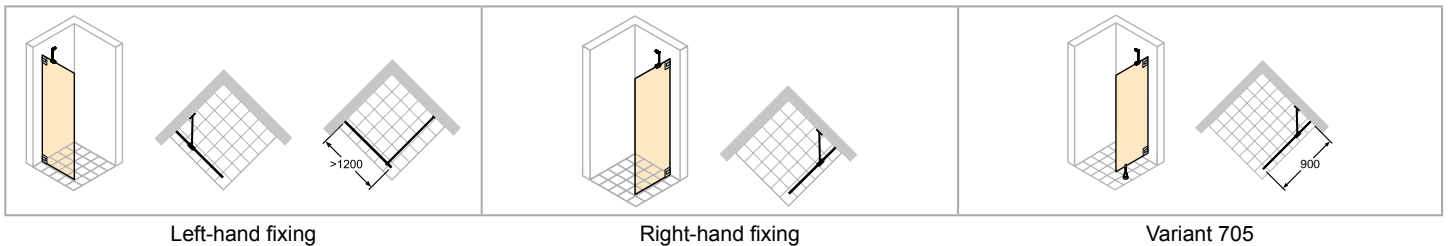
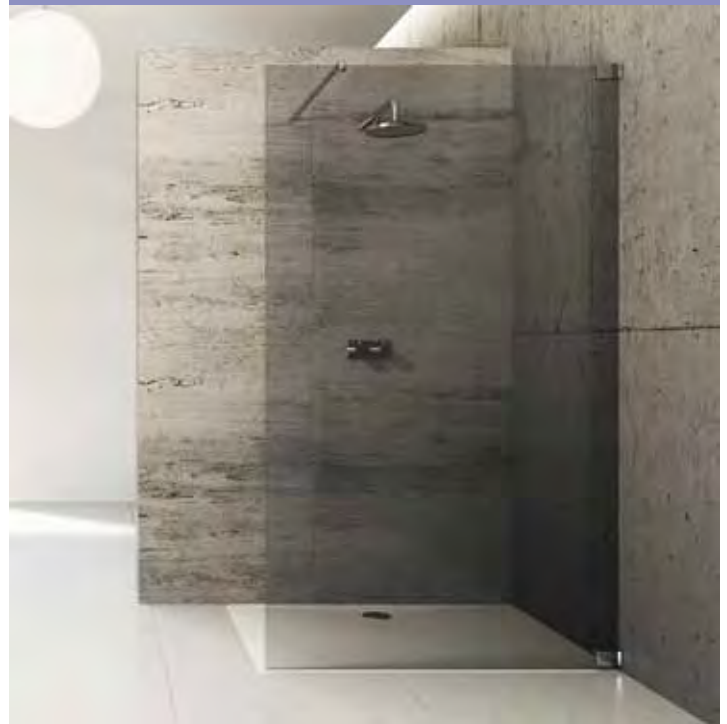

Left-hand fixing

Right-hand fixing

Variant 705

- Measurements must always be taken.
- Price including slopes and cut-outs.
- Side panel can also be used as a partition outside the shower area.
- Basic colour brilliant gold: drip deflector strip and design profile in pearl gold.
- Individual galvanised surfaces: stainless steel look, old brass, high grade brass.
- Towel rail height can be selected individually and must be specified with the order. If nothing is specified, the towel rail is always delivered middle of glass (height and width).

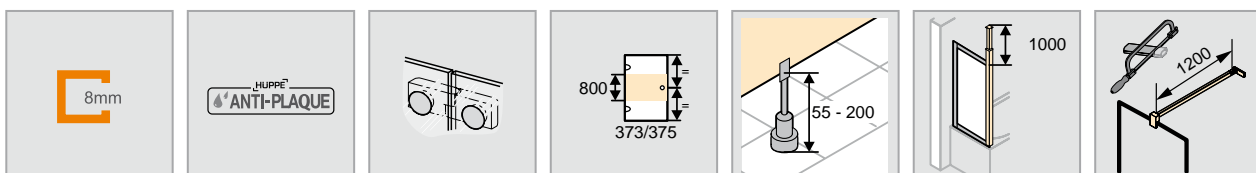
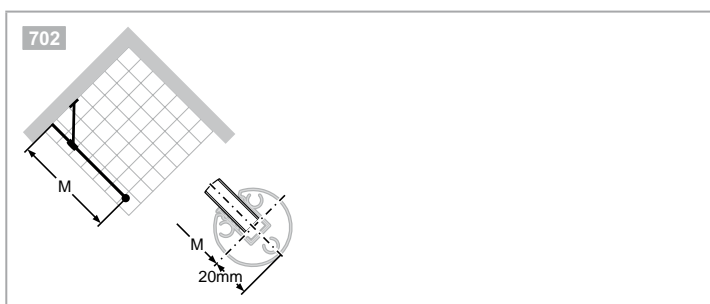

Free standing side panel



Made-to-measure - Left-hand fixing

Height	Model	Width	PARIS	BERLIN	Base price
600-2000	Side panel with stabilizer	200-1200	PR0579	BR0579	836,-
	Side panel with cross-bracing	200-1200	PR0578	BR0578	
	Side panel with cross-bracing	1201-1800	PR057H	BR057H	1.230,-
2001-2400	Side panel with stabilizer	200-1200	PR057F	BR057F	1.183,-
	Side panel with cross-bracing	200-1200	PR057J	BR057J	
	Side panel with cross-bracing	1201-1800	PR057K	BR057K	1.575,-

Made-to-measure - Right-hand fixing

Height	Model	Width	PARIS	BERLIN	Base price
600-2000	Side panel with stabilizer	200-1200	PR0589	BR0589	836,-
	Side panel with cross-bracing	200-1200	PR0588	BR0588	
	Side panel with cross-bracing	1201-1800	PR058H	BR058H	1.230,-
2001-2400	Side panel with stabilizer	200-1200	PR058F	BR058F	1.183,-
	Side panel with cross-bracing	200-1200	PR058J	BR058J	
	Side panel with cross-bracing	1201-1800	PR058K	BR058K	1.575,-

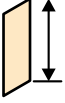
Dim. Range: min. - max.

	
600-2400	200-1800

Special options

Optional variants		Extra charges
Design profile with ceiling connection. Ceiling connection min. 160mm	702	213,-
Aluminium profile for mounting flush with the floor	706	151,-
Aluminium profile for mounting flush with the floor and design profile with ceiling connection	707	364,-
Base	705	151,-
Towel rail (high-gloss silver as standard, towel rail in black for Black Edition systems)	T99	210,-
Towel rail and ceiling connection. Ceiling connection min. 160mm.	T02	423,-
Towel rail and aluminium profile for mounting flush with the floor	T06	361,-
Towel rail, aluminium profile for mounting flush with the floor and design profile with ceiling connection	T07	574,-
Towel rail and base	T05	361,-

Colours - Panel options

Basic/inlay colours	Colour code	Extra charges	Panel options	without Anti-Plaque		with Anti-Plaque	
				Glass code	Extra charges	Glass code	Extra charges
Black Edition	123	171,-	Clear	321	0,-	322	209,-
Individual RAL colours	998	303,-	Karo	311		312	
Individual galvanised surfaces	999	726,-	Sand Plus	315	186,-	316	395,-
Basic colours			Privatima	373		375	
Fittings			Mirror glass	380	657,-	381	866,-
High-grade matt chrome	E	0,-	Further panel options HÜPPE Studio Paris elegance/ HÜPPE Studio Berlin pure - see chapter intro.				
Chrome	C	177,-					
Brilliant gold	G	250,-					
Inlay colours	Colour code	Extra charges					
Brilliant gold	02	0,-					
High-grade matt chrome	05						
Black	23						
White	55						
Chrome	91						

HÜPPE Studio Paris elegance frameless Rectangular
HÜPPE Studio Berlin pure frameless Rectangular

HÜPPE Studio Paris elegance



HÜPPE Studio Berlin pure

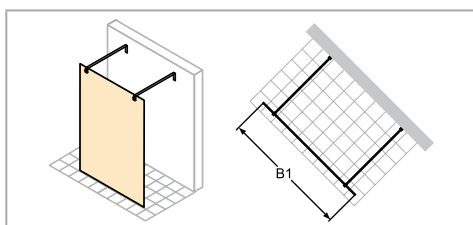

- Measurements must always be taken.
- Price including slopes and cut-outs.
- Side panel parts have no inlays, therefore supplied in basic colour.
- With basic colour brilliant gold the cross bar profile is in pearl gold.
- Towel rail height can be selected individually and must be specified with the order. If nothing is specified, the towel rail is always delivered middle of glass (height and width).

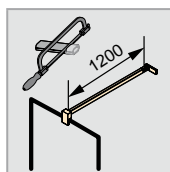
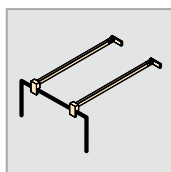
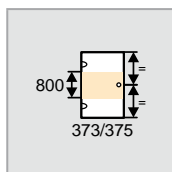
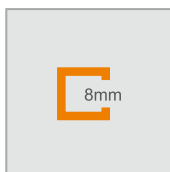



Free-standing side panel

Made-to-measure

Height	Width B1	PARIS	BERLIN	Base price
1200-2000	300-1200	PR0509	BR0509	836,-
	1201-1800	PR050E	BR050E	1.230,-
2001-2200	300-1200	PR050F	BR050F	1.183,-
	1201-1800	PR050G	BR050G	1.575,-

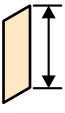
Dim. Range: min. - max.

	
1200-2200	300-1800

Special options

Optional variants		Extra charges
Aluminium profile for mounting flush with the floor	706	151,-
Towel rail (high-gloss silver as standard, towel rail in black for Black Edition systems)	T99	210,-
Towel rail and aluminium profile for mounting flush with the floor	T06	361,-

Colours - Panel options

Basic colours	Colour code	Extra charges	Panel options	without Anti-Plaque		with Anti-Plaque	
				Glass code	Extra charges	Glass code	Extra charges
High-grade matt chrome/high-grade matt chrome	E05	0,-	Clear	321	0,-	322	209,-
Black Edition	123	171,-	Karo	311	186,-	312	395,-
Chrome/chrome	C91	177,-	Sand Plus	315		316	
Brilliant gold/brilliant gold	G02	250,-	Privatima	373		375	
Individual RAL colours	998	303,-	Mirror glass	380	657,-	381	866,-

**Further panel options HÜPPE Studio Paris elegance/
HÜPPE Studio Berlin pure - see chapter intro.**

HÜPPE Studio Paris elegance frameless Rectangular

HÜPPE Studio Berlin pure frameless Rectangular

HÜPPE Studio Paris elegance

HÜPPE Studio Berlin pure

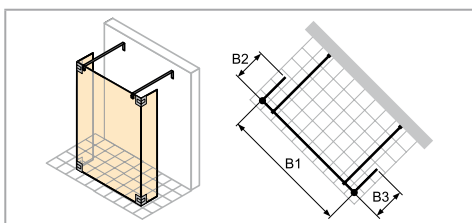
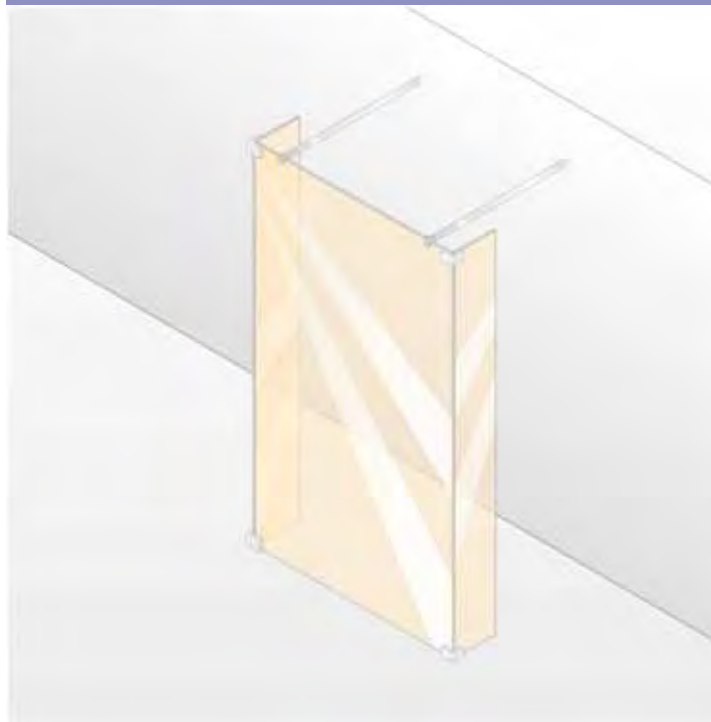
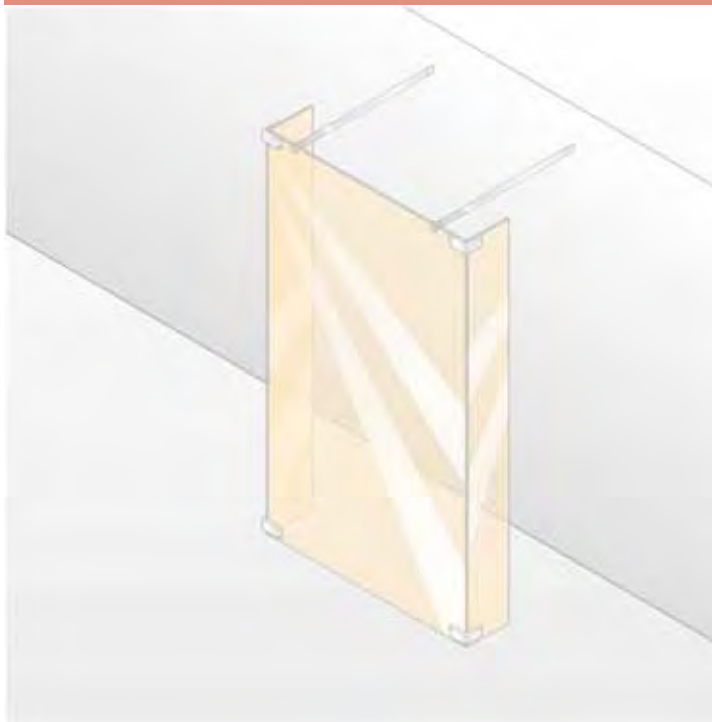

- Measurements must always be taken.
- Price including slopes and cut-outs.
- If small side panels are movable, then corner joint with design profile.
- Basic colour brilliant gold: cross-bracing profile and design profile in pearl gold.
- Individual galvanised surfaces: stainless steel look, old brass, high grade brass.
- Mirror glass (380/381): Please state in your order which segment should be produced with mirror glass. If this is not stated, the entire unit will be produced with mirror glass.
- For technical information, see Profile Colours and Panel Options section.
- Towel rail height can be selected individually and must be specified with the order. If nothing is specified, the towel rail is always delivered middle of glass (height and width).

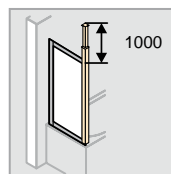
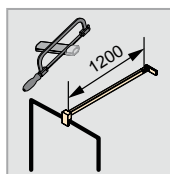
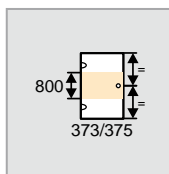
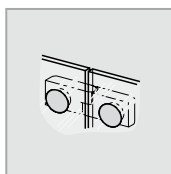
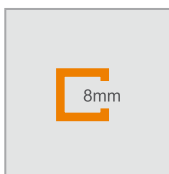
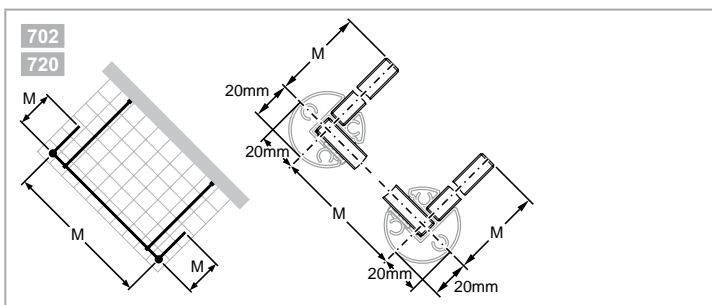

Walk-In model 1

Made-to-measure

Height	Width SW B2	Width SW B1	Width SW B3	PARIS	BERLIN	Base price
1200-2000	300-600	1200-1800	300-600	PR0709	BR0709	2.428,-
2001-2200	300-600	1200-1800	300-600	PR070E	BR070E	2.775,-

Dim. Range: min. - max.

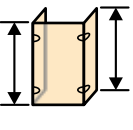
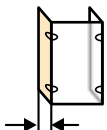
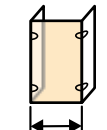
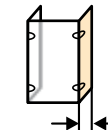
			
1200-2200	300-600	1200-1800	300-600

Special options

Optional variants		Extra charges
Design profile with ceiling connection. Ceiling connection min. 160mm	702	213,-
Narrow side panel movable	720	393,-
Ceiling connection and narrow side panel movable	721	604,-
Towel rail (high-gloss silver as standard, towel rail in black for Black Edition systems)	T99	210,-
Towel rail and ceiling connection. Ceiling connection min. 160mm.	T02	423,-
Towel rail and narrow side panel movable	T20	603,-
Towel rail, ceiling connection and narrow side panel, movable	T21	814,-

Colours - Panel options

Basic/inlay colours	Colour code	Extra charges	Panel options	without Anti-Plaque		with Anti-Plaque	
				Glass code	Extra charges	Glass code	Extra charges
Black Edition	123	171,-	Clear	321	0,-	322	209,-
Individual RAL colours	998	388,-	Karo	311		312	
Individual galvanised surfaces	999	726,-	Sand Plus	315	186,-	316	395,-
Basic colours			Privatima	373		375	
Fittings			Mirror glass	380	439,-	381	648,-
High-grade matt chrome	E	0,-	Further panel options HÜPPE Studio Paris elegance/ HÜPPE Studio Berlin pure - see chapter intro.				
Chrome	C	303,-					
Brilliant gold	G	377,-					
Inlay colours	Colour code	Extra charges					
Brilliant gold	02	0,-					
High-grade matt chrome	05						
Black	23						
White	55						
Chrome	91						

HÜPPE Studio Paris elegance frameless Rectangular

HÜPPE Studio Berlin pure frameless Rectangular

HÜPPE Studio Paris elegance

HÜPPE Studio Berlin pure

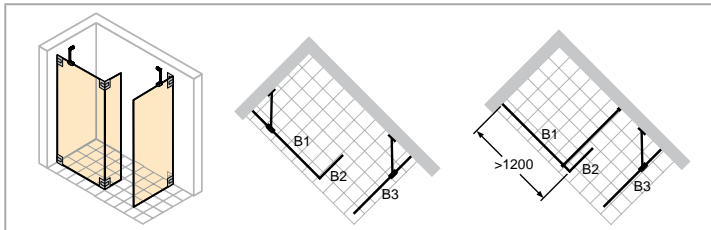
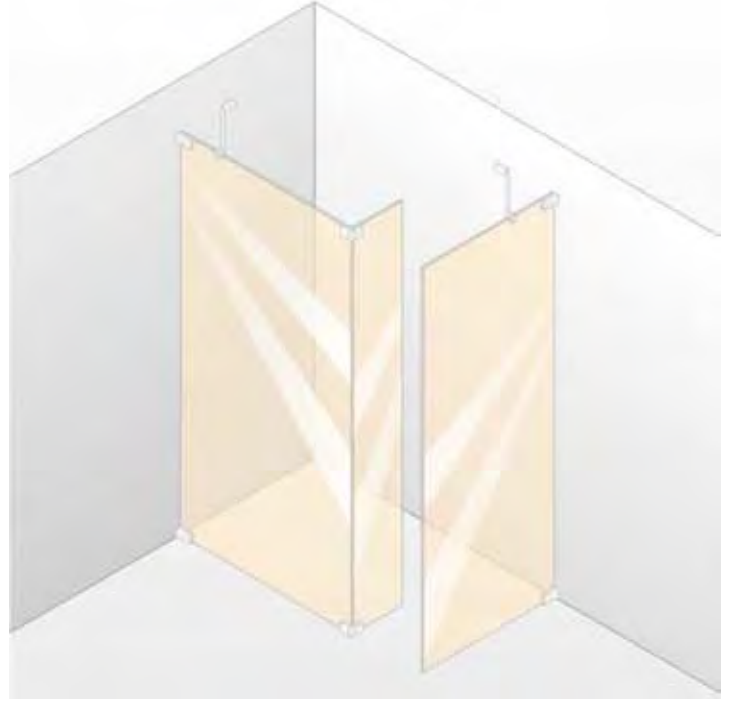
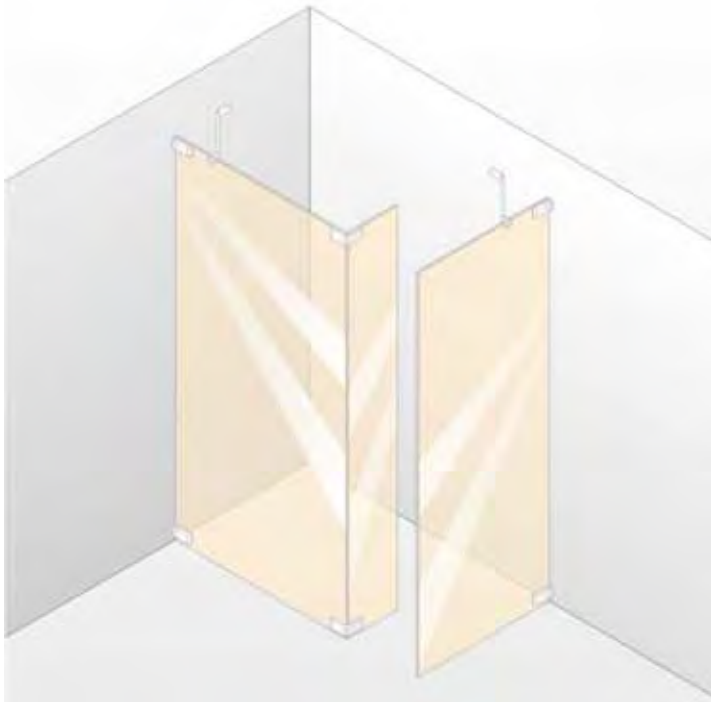

Left-hand fixing

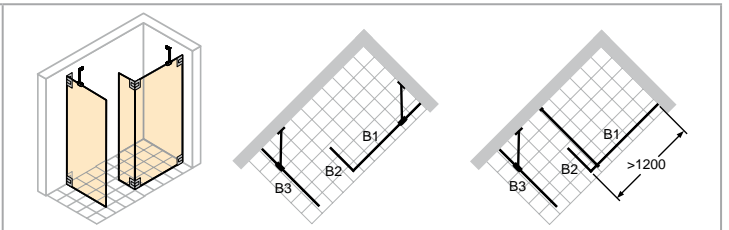

Right-hand fixing

- Measurements must always be taken.
- Price including slopes and cut-outs.
- If small side panel is movable, then corner joint with design profile.
- Basic colour brilliant gold: cross-bracing profile and design profile in pearl gold.
- Individual galvanised surfaces: stainless steel look, old brass, high grade brass.
- Mirror glass (380/381): Please state in your order which segment should be produced with mirror glass.
If this is not stated, the entire unit will be produced with mirror glass.
- For technical information, see Profile Colours and Panel Options section.
- Towel rail height can be selected individually and must be specified with the order. If nothing is specified, the towel rail is always delivered middle of glass (height and width).

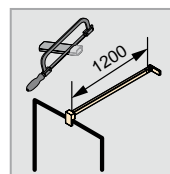
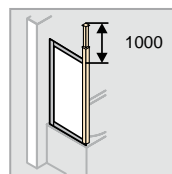
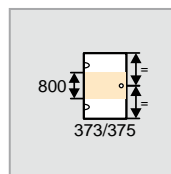
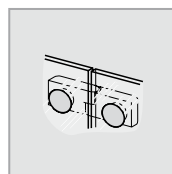
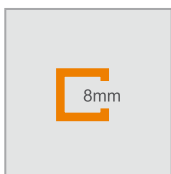
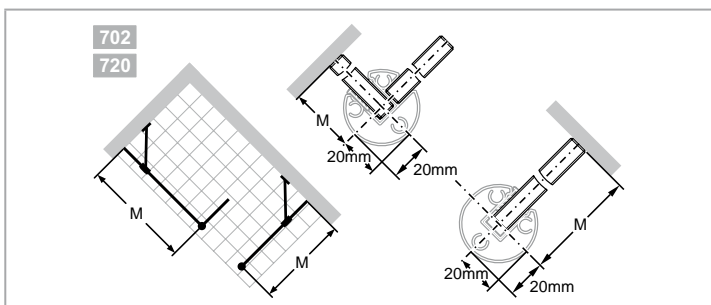

Walk-In model 2



Made-to-measure - Left-hand fixing

Height	Width SW B1	Width SW B2	Width SW B3	PARIS	BERLIN	Base price
1200-2000	300-1200	300-600	300-1200	PR0719	BR0719	2.428,-
	300-1200	300-600	1201-1800	PR071E	BR071E	2.822,-
	1201-1800	300-600	1201-1800	PR071F	BR071F	3.214,-
2001-2200	300-1200	300-600	300-1200	PR071G	BR071G	2.775,-
	300-1200	300-600	1201-1800	PR071H	BR071H	3.168,-
	1201-1800	300-600	1201-1800	PR071J	BR071J	3.562,-

Made-to-measure - Right-hand fixing

Height	Width SW B1	Width SW B2	Width SW B3	PARIS	BERLIN	Base price
1200-2000	300-1200	300-600	300-1200	PR0729	BR0729	2.428,-
	300-1200	300-600	1201-1800	PR072E	BR072E	2.822,-
	1201-1800	300-600	1201-1800	PR072F	BR072F	3.214,-
2001-2200	300-1200	300-600	300-1200	PR072G	BR072G	2.775,-
	300-1200	300-600	1201-1800	PR072H	BR072H	3.168,-
	1201-1800	300-600	1201-1800	PR072J	BR072J	3.562,-

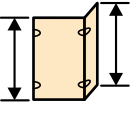
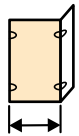
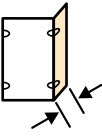
Dim. Range: min. - max.

			
1200-2200	300-1800	300-600	300-1800

Special options

Optional variants		Extra charges
Design profile with ceiling connection. Ceiling connection min. 160mm	702	213,-
Narrow side panel movable	720	393,-
Ceiling connection and narrow side panel movable	721	604,-
Towel rail (high-gloss silver as standard, towel rail in black for Black Edition systems)	T99	210,-
Towel rail and ceiling connection. Ceiling connection min. 160mm.	T02	423,-
Towel rail and narrow side panel movable	T20	603,-
Towel rail, ceiling connection and narrow side panel, movable	T21	814,-

Colours - Panel options

Basic/inlay colours	Colour code	Extra charges	Panel options	without Anti-Plaque		with Anti-Plaque	
				Glass code	Extra charges	Glass code	Extra charges
Black Edition	123	171,-	Clear	321	0,-	322	209,-
Individual RAL colours	998	388,-	Karo	311		312	
Individual galvanised surfaces	999	726,-	Sand Plus	315	186,-	316	395,-
Basic colours			Privatima	373		375	
Fittings			Mirror glass	380	439,-	381	648,-
High-grade matt chrome	E	0,-	Further panel options HÜPPE Studio Paris elegance/ HÜPPE Studio Berlin pure - see chapter intro.				
Chrome	C	303,-					
Brilliant gold	G	377,-					
Inlay colours	Colour code	Extra charges					
Brilliant gold	02	0,-					
High-grade matt chrome	05						
Black	23						
White	55						
Chrome	91						

HÜPPE Studio Paris elegance frameless Rectangular

HÜPPE Studio Berlin pure frameless Rectangular

HÜPPE Studio Paris elegance

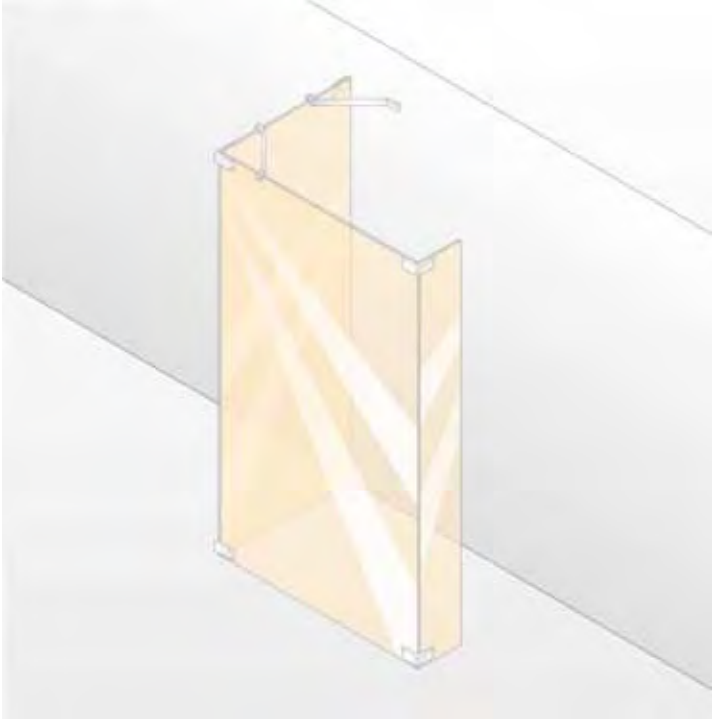

HÜPPE Studio Berlin pure

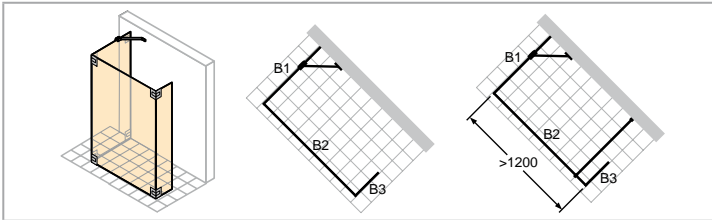
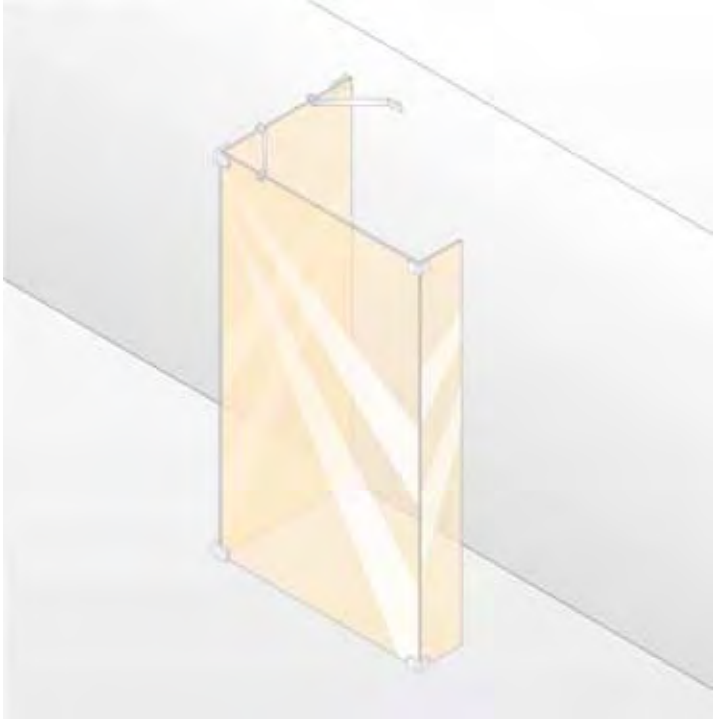

Left-hand fixing

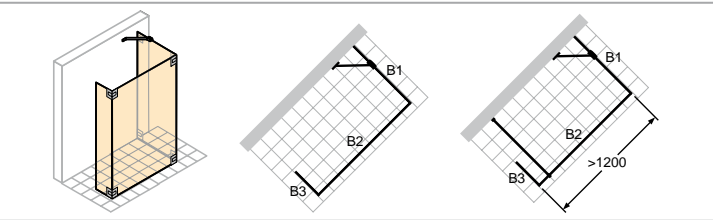

Right-hand fixing

- Measurements must always be taken.
- Price including slopes and cut-outs.
- If small side panel is movable, then corner joint with design profile.
- Basic colour brilliant gold: cross-bracing profile and design profile in pearl gold.
- Individual galvanised surfaces: stainless steel look, old brass, high grade brass.
- Mirror glass (380/381): Please state in your order which segment should be produced with mirror glass. If this is not stated, the entire unit will be produced with mirror glass.
- For technical information, see Profile Colours and Panel Options section.
- Towel rail height can be selected individually and must be specified with the order. If nothing is specified, the towel rail is always delivered middle of glass (height and width).

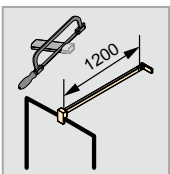
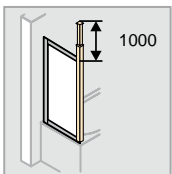
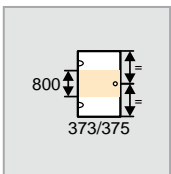
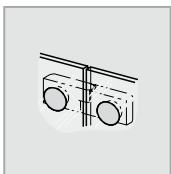
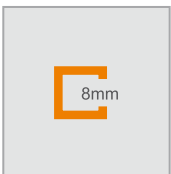
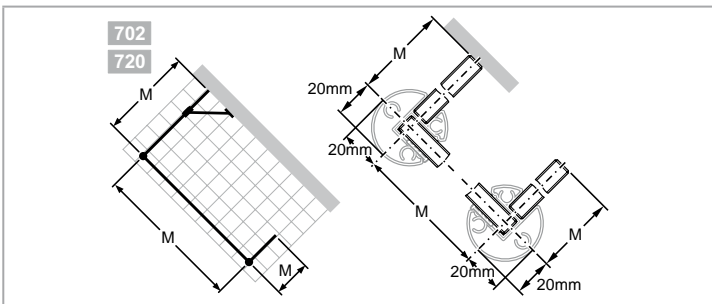

Walk-In model 3

Made-to-measure - Left-hand fixing

Height	Width SW B1	Width SW B2	Width SW B3	PARIS	BERLIN	Base price
1200-2000	300-1200	300-1200	300-600	PR0739	BR0739	2.428,-
	300-1200	1201-1800	300-600	PR073E	BR073E	2.822,-
	1201-1800	1201-1800	300-600	PR073F	BR073F	3.214,-
2001-2200	300-1200	300-1200	300-600	PR073G	BR073G	2.775,-
	300-1200	1201-1800	300-600	PR073H	BR073H	3.168,-
	1201-1800	1201-1800	300-600	PR073J	BR073J	3.562,-

Made-to-measure - Right-hand fixing

Height	Width SW B1	Width SW B2	Width SW B3	PARIS	BERLIN	Base price
1200-2000	300-1200	300-1200	300-600	PR0749	BR0749	2.428,-
	300-1200	1201-1800	300-600	PR074E	BR074E	2.822,-
	1201-1800	1201-1800	300-600	PR074F	BR074F	3.214,-
2001-2200	300-1200	300-1200	300-600	PR074G	BR074G	2.775,-
	300-1200	1201-1800	300-600	PR074H	BR074H	3.168,-
	1201-1800	1201-1800	300-600	PR074J	BR074J	3.562,-

Dim. Range: min. - max.

1200-2200	300-1800	300-1800	300-600

Special options

Optional variants		Extra charges
Design profile with ceiling connection. Ceiling connection min. 160mm	702	213,-
Narrow side panel movable	720	393,-
Ceiling connection and narrow side panel movable	721	604,-
Towel rail (high-gloss silver as standard, towel rail in black for Black Edition systems)	T99	210,-
Towel rail and ceiling connection. Ceiling connection min. 160mm.	T02	423,-
Towel rail and narrow side panel movable	T20	603,-
Towel rail, ceiling connection and narrow side panel, movable	T21	814,-

Colours - Panel options

Basic/inlay colours	Colour code	Extra charges	Panel options	without Anti-Plaque		with Anti-Plaque	
				Glass code	Extra charges	Glass code	Extra charges
Black Edition	123	171,-	Clear	321	0,-	322	209,-
Individual RAL colours	998	388,-	Karo	311		312	
Individual galvanised surfaces	999	726,-	Sand Plus	315	186,-	316	395,-
Basic colours			Privatima	373		375	
Fittings			Mirror glass	380	439,-	381	648,-
High-grade matt chrome	E	0,-	Further panel options HÜPPE Studio Paris elegance/ HÜPPE Studio Berlin pure - see chapter intro.				
Chrome	C	303,-					
Brilliant gold	G	377,-					
Inlay colours	Colour code	Extra charges					
Brilliant gold	02	0,-					
High-grade matt chrome	05						
Black	23						
White	55						
Chrome	91						

HÜPPE Studio Paris elegance frameless Rectangular
HÜPPE Studio Berlin pure frameless Rectangular

HÜPPE Studio Paris elegance



HÜPPE Studio Berlin pure

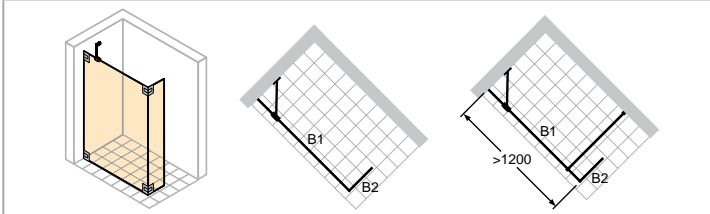

Left-hand fixing

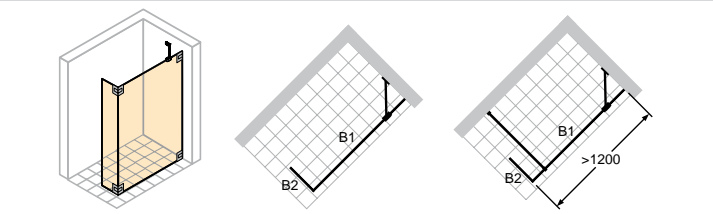

Right-hand fixing

- Measurements must always be taken.
- Price including slopes and cut-outs.
- If small side panel is movable, then corner joint with design profile.
- Basic colour brilliant gold: cross-bracing profile and design profile in pearl gold.
- Individual galvanised surfaces: stainless steel look, old brass, high grade brass.
- Mirror glass (380/381): Please state in your order which segment should be produced with mirror glass. If this is not stated, the entire unit will be produced with mirror glass.
- For technical information, see Profile Colours and Panel Options section.
- Towel rail height can be selected individually and must be specified with the order. If nothing is specified, the towel rail is always delivered middle of glass (height and width).

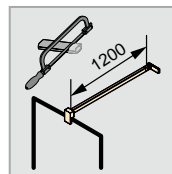
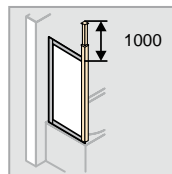
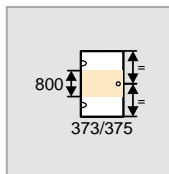
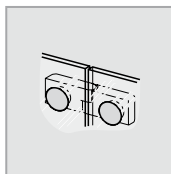
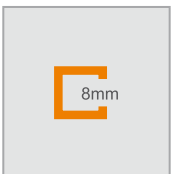
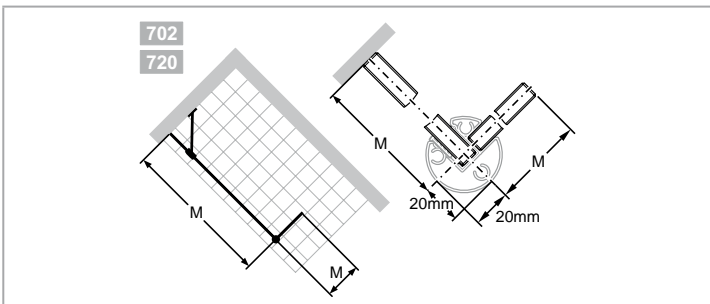

Walk-In model 4

Made-to-measure - Left-hand fixing

Height	Width SW B1	Width SW B2	PARIS	BERLIN	Base price
1200-2000	300-1200	300-600	PR0759	BR0759	1.159,-
	1201-1800	300-600	PR075E	BR075E	1.553,-
2001-2200	300-1200	300-600	PR075F	BR075F	1.506,-
	1201-1800	300-600	PR075G	BR075G	1.899,-

Made-to-measure - Right-hand fixing

Height	Width SW B1	Width SW B2	PARIS	BERLIN	Base price
1200-2000	300-1200	300-600	PR0769	BR0769	1.159,-
	1201-1800	300-600	PR076E	BR076E	1.553,-
2001-2200	300-1200	300-600	PR076F	BR076F	1.506,-
	1201-1800	300-600	PR076G	BR076G	1.899,-

Dim. Range: min. - max.

1200-2200	300-1800	300-600

Special options

Optional variants		Extra charges
Design profile with ceiling connection. Ceiling connection min. 160mm	702	213,-
Narrow side panel movable	720	393,-
Ceiling connection and narrow side panel movable	721	604,-
Towel rail (high-gloss silver as standard, towel rail in black for Black Edition systems)	T99	210,-
Towel rail and ceiling connection. Ceiling connection min. 160mm.	T02	423,-
Towel rail and narrow side panel movable	T20	603,-
Towel rail, ceiling connection and narrow side panel, movable	T21	814,-

Colours - Panel options

Basic/inlay colours	Colour code	Extra charges	Panel options		without Anti-Plaque		with Anti-Plaque	
			Glass code	Extra charges	Glass code	Extra charges		
Black Edition	123	171,-	Clear	321	0,-	322	209,-	
Individual RAL colours	998	303,-	Karo	311		312		
Individual galvanised surfaces	999	726,-	Sand Plus	315	186,-	316	395,-	
Basic colours			Privatima	373		375		
Fittings			Mirror glass	380	439,-	381	648,-	

**Further panel options HÜPPE Studio Paris elegance/
HÜPPE Studio Berlin pure - see chapter intro.**

Inlay colours	Colour code	Extra charges
Brilliant gold	02	0,-
High-grade matt chrome	05	
Black	23	
White	55	
Chrome	91	

HÜPPE Studio Paris elegance partially framed Rectangular
HÜPPE Studio Berlin pure partially framed Rectangular

HÜPPE Studio Paris elegance



HÜPPE Studio Berlin pure

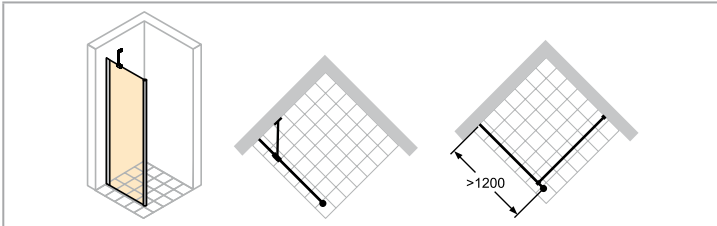

Left-hand fixing

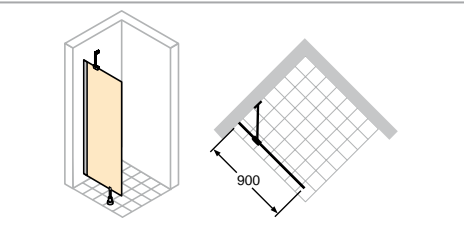

Variant 723

- Price including slopes and cut-outs.
- Side panel parts have no inlays, therefore supplied in basic colour.
- Towel rail height can be selected individually and must be specified with the order. If nothing is specified, the towel rail is always delivered middle of glass (height and width).

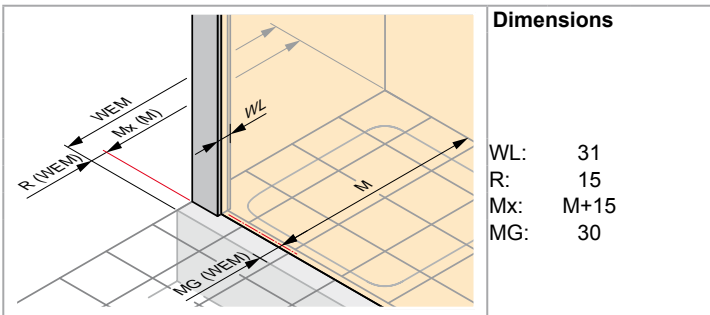

Dimensions

- WL: 31
- R: 15
- Mx: M+15
- MG: 30

WEM = Tray installation dim. (000)
 M = installation dimension Centre glass (001)
 Please always specify when ordering.

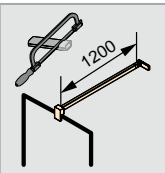
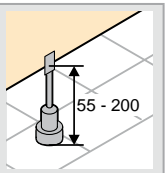
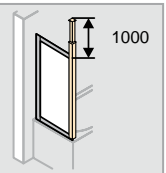
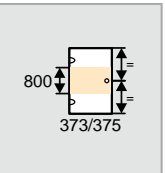
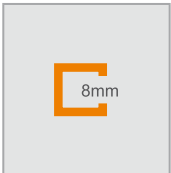
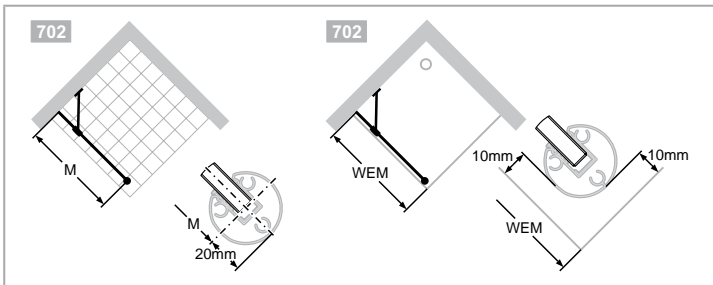

HÜPPE Studio Paris elegance partially framed Rectangular

HÜPPE Studio Berlin pure partially framed Rectangular

Free standing side panel

Left-hand fixing

Height	Model	WEM	Width	PARIS	BERLIN	Base price
2000	750	740-750	710-720	PT0570	BT0570	836,-
	800	790-800	760-770	PT0571	BT0571	
	900	890-900	860-870	PT0572	BT0572	
	1000	990-1000	960-970	PT0573	BT0573	

Made-to-measure - Left-hand fixing

Height	Model	Width	PARIS	BERLIN	Base price
1200-2000	Side panel with stabilizer	300-1200	PT0579	BT0579	836,-
2001-2200	Side panel with stabilizer	300-1200	PT057F	BT057F	1.183,-
600-2000	Side panel with cross-bracing	200-1200	PT0578	BT0578	836,-
	Side panel with cross-bracing	1201-1800	PT057H	BT057H	1.230,-
2001-2200	Side panel with cross-bracing	200-1200	PT057J	BT057J	1.183,-
	Side panel with cross-bracing	1201-1800	PT057K	BT057K	1.575,-

Adjustment range = dimensions - 5mm / + 5mm

Dim. Range: min. - max.

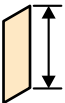
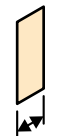
	
600-2200	200-1800

Special options

Optional variants		Supplement
Without design profile	722	0,-
Without design profile with base	723	151,-
Design profile with ceiling connection. Ceiling connection min. 160mm	702	213,-
Aluminium profile for mounting flush with the floor	706	151,-
Floor profile with ceiling connection	707	364,-
Towel rail (high-gloss silver as standard, towel rail in black for Black Edition systems)	T99	210,-
Towel rail and without design profile	T22	
Towel rail and without design profile with base	T23	361,-
Towel rail and ceiling connection. Ceiling connection min. 160mm.	T02	423,-
Towel rail and aluminium profile for mounting flush with the floor	T06	361,-
Towel rail and floor profile with ceiling connection	T07	574,-

Colours - Panel options

Basic colours	Colour code	Extra charges	Panel options	without Anti-Plaque		with Anti-Plaque	
				Glass code	Extra charges	Glass code	Extra charges
High-grade matt chrome/high-grade matt chrome	E05	0,-	Clear	321	0,-	322	209,-
Black Edition	123	171,-	Karo	311		312	
Chrome/chrome	C91	177,-	Sand Plus	315	186,-	316	395,-
Individual RAL colours	998	303,-	Privatima	373		375	
			Mirror glass	380	657,-	381	866,-

Further panel options HÜPPE Studio Paris elegance/
HÜPPE Studio Berlin pure - see chapter intro.

HÜPPE Studio Paris elegance partially framed Rectangular
HÜPPE Studio Berlin pure partially framed Rectangular

HÜPPE Studio Paris elegance



HÜPPE Studio Berlin pure

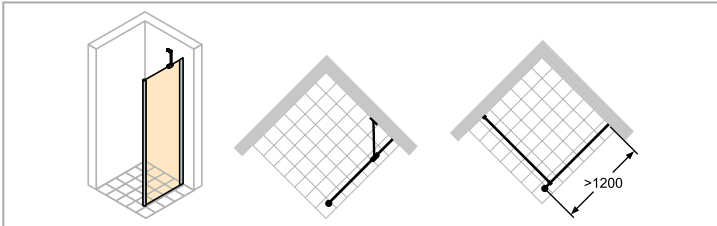

Right-hand fixing

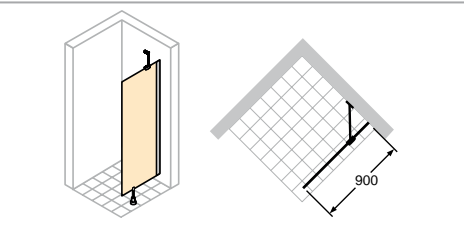

Variant 723

- Price including slopes and cut-outs.
- Side panel parts have no inlays, therefore supplied in basic colour.
- Towel rail height can be selected individually and must be specified with the order. If nothing is specified, the towel rail is always delivered middle of glass (height and width).

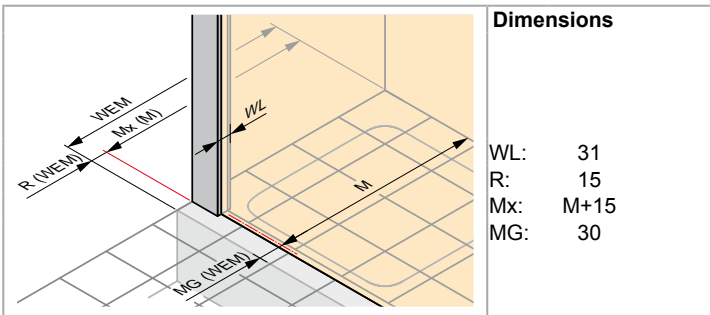

Dimensions

- WL: 31
- R: 15
- Mx: M+15
- MG: 30

WEM = Tray installation dim. (000)
 M = installation dimension Centre glass (001)
 Please always specify when ordering.

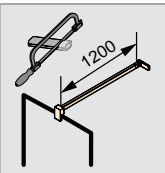
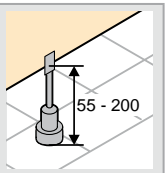
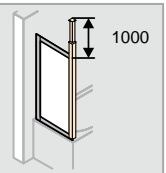
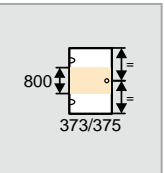
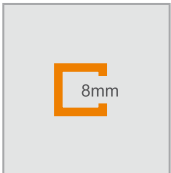
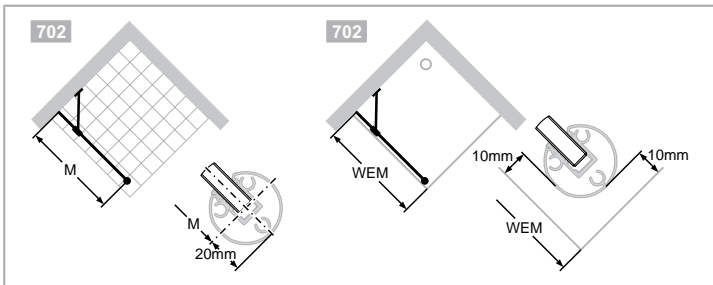

HÜPPE Studio Paris elegance partially framed Rectangular

HÜPPE Studio Berlin pure partially framed Rectangular

Free standing side panel

Right-hand fixing

Height	Model	WEM	Width	PARIS	BERLIN	Base price
2000	750	740-750	710-720	PT0580	BT0580	836,-
	800	790-800	760-770	PT0581	BT0581	
	900	890-900	860-870	PT0582	BT0582	
	1000	990-1000	960-970	PT0583	BT0583	

Made-to-measure - Right-hand fixing

Height	Model	Width	PARIS	BERLIN	Base price
1200-2000	Side panel with stabilizer	300-1200	PT0589	BT0589	836,-
2001-2200	Side panel with stabilizer	300-1200	PT058F	BT058F	1.183,-
600-2000	Side panel with cross-bracing	200-1200	PT0588	BT0588	836,-
	Side panel with cross-bracing	1201-1800	PT058H	BT058H	1.230,-
2001-2200	Side panel with cross-bracing	200-1200	PT058J	BT058J	1.183,-
	Side panel with cross-bracing	1201-1800	PT058K	BT058K	1.575,-

Adjustment range = dimensions - 5mm / + 5mm

Dim. Range: min. - max.

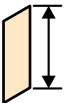
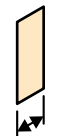
	
600-2200	200-1800

Special options

Optional variants		Supplement
Without design profile	722	0,-
Without design profile with base	723	151,-
Design profile with ceiling connection. Ceiling connection min. 160mm	702	213,-
Aluminium profile for mounting flush with the floor	706	151,-
Floor profile with ceiling connection	707	364,-
Towel rail (high-gloss silver as standard, towel rail in black for Black Edition systems)	T99	210,-
Towel rail and without design profile	T22	
Towel rail and without design profile with base	T23	361,-
Towel rail and ceiling connection. Ceiling connection min. 160mm.	T02	423,-
Towel rail and aluminium profile for mounting flush with the floor	T06	361,-
Towel rail and floor profile with ceiling connection	T07	574,-

Colours - Panel options

Basic colours	Colour code	Extra charges	Panel options	without Anti-Plaque		with Anti-Plaque	
				Glass code	Extra charges	Glass code	Extra charges
High-grade matt chrome/high-grade matt chrome	E05	0,-	Clear	321	0,-	322	209,-
Black Edition	123	171,-	Karo	311		312	
Chrome/chrome	C91	177,-	Sand Plus	315	186,-	316	395,-
Individual RAL colours	998	303,-	Privatima	373		375	
			Mirror glass	380	657,-	381	866,-

Further panel options HÜPPE Studio Paris elegance/
HÜPPE Studio Berlin pure - see chapter intro.

HÜPPE Studio Paris elegance partially framed Rectangular
HÜPPE Studio Berlin pure partially framed Rectangular

HÜPPE Studio Paris elegance



HÜPPE Studio Berlin pure

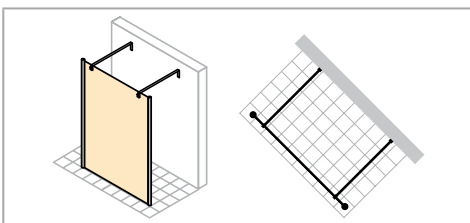

- Price including slopes and cut-outs.
- Side panel/partition parts have no inlays, therefore supplied in basic colour.
- Towel rail height can be selected individually and must be specified with the order. If nothing is specified, the towel rail is always delivered middle of glass (height and width).

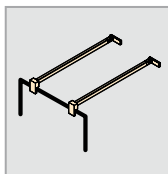
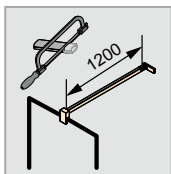
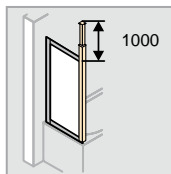
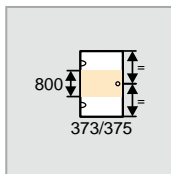
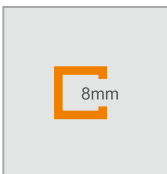
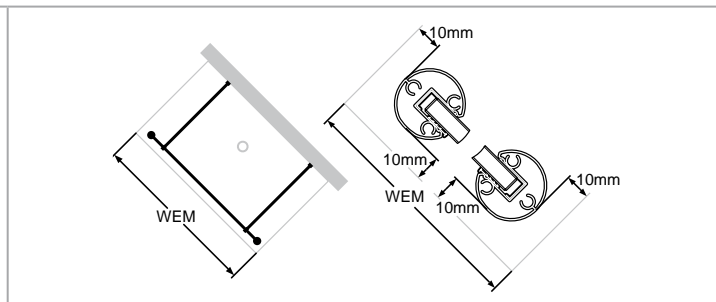
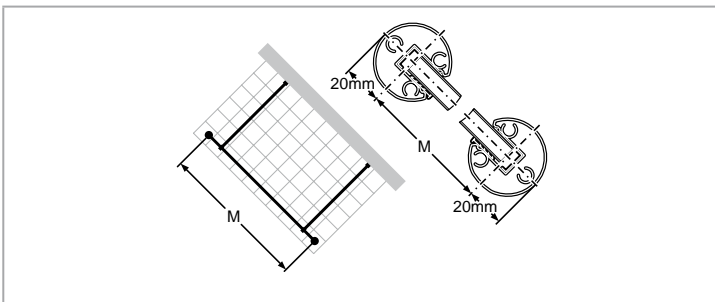

HÜPPE Studio Paris elegance partially framed Rectangular



HÜPPE Studio Berlin pure partially framed Rectangular

Free-standing side panel

Made-to-measure

Height	Width	PARIS	BERLIN	Base price
1200-2000	300-1200	PT0509	BT0509	836,-
	1201-1800	PT050E	BT050E	1.230,-
2001-2200	300-1200	PT050F	BT050F	1.183,-
	1201-1800	PT050G	BT050G	1.575,-

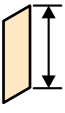
Dim. Range: min. - max.

	
1200-2200	300-1800

Special options

Optional variants		Extra charges
Design profile with ceiling connection. Ceiling connection min. 160mm	702	213,-
Aluminium profile for mounting flush with the floor	706	151,-
Floor profile with ceiling connection	707	364,-
Towel rail (high-gloss silver as standard, towel rail in black for Black Edition systems)	T99	210,-
Towel rail and ceiling connection. Ceiling connection min. 160mm.	T02	423,-
Towel rail and aluminium profile for mounting flush with the floor	T06	361,-
Towel rail and floor profile with ceiling connection	T07	574,-

Colours - Panel options

Basic colours	Colour code	Extra charges	Panel options	without Anti-Plaque		with Anti-Plaque	
				Glass code	Extra charges	Glass code	Extra charges
High-grade matt chrome/high-grade matt chrome	E05	0,-	Clear	321	0,-	322	209,-
Black Edition	123	171,-	Karo	311	186,-	312	395,-
Chrome/chrome	C91	177,-	Sand Plus	315		316	
Individual RAL colours	998	303,-	Privatima	373		375	
			Mirror glass	380	657,-	381	866,-

**Further panel options HÜPPE Studio Paris elegance/
HÜPPE Studio Berlin pure - see chapter intro.**

HÜPPE Studio Paris elegance partially framed Rectangular

HÜPPE Studio Berlin pure partially framed Rectangular

HÜPPE Studio Paris elegance

HÜPPE Studio Berlin pure

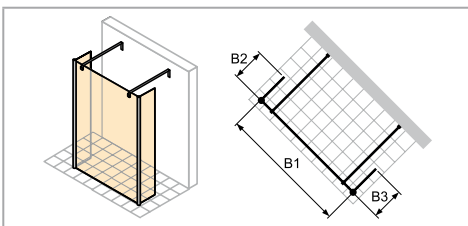
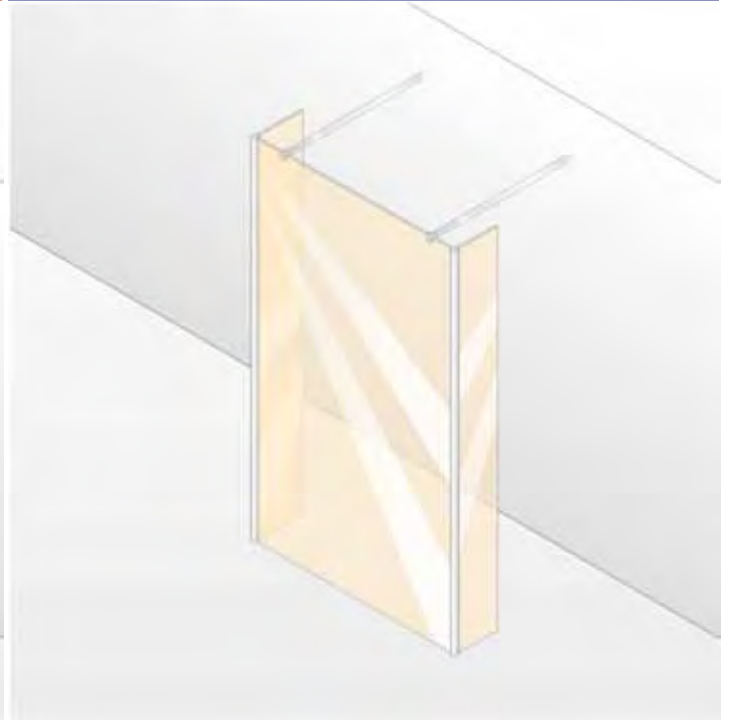
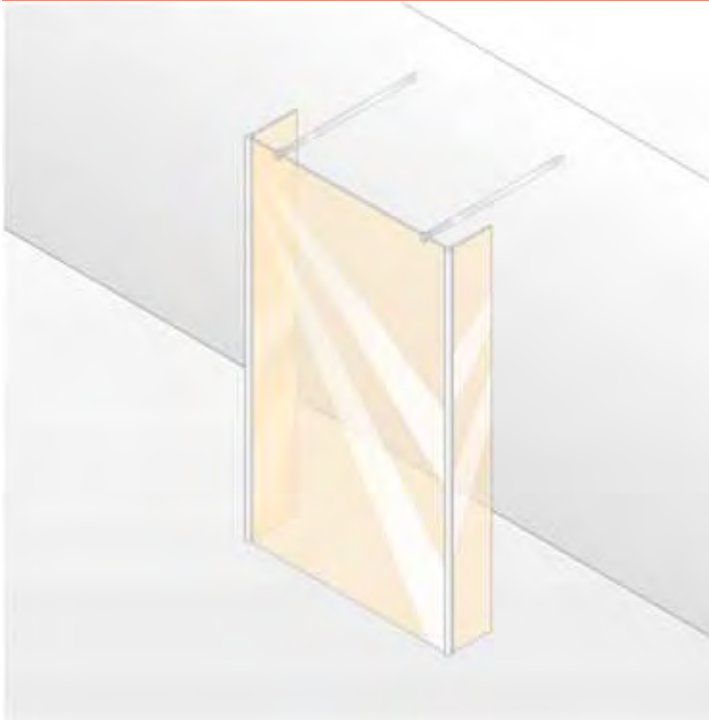

- Price including slopes and cut-outs.
- Walk-In parts have no inlays, therefore supplied in basic colour.
- Mirror glass (380/381): Please state in your order which segment should be produced with mirror glass. If this is not stated, the entire unit will be produced with mirror glass.
- For technical information, see Profile Colours and Panel Options section.
- Towel rail height can be selected individually and must be specified with the order. If nothing is specified, the towel rail is always delivered middle of glass (height and width).

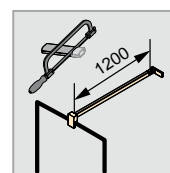
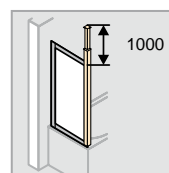
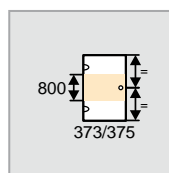
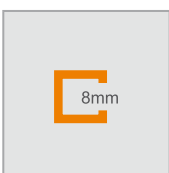
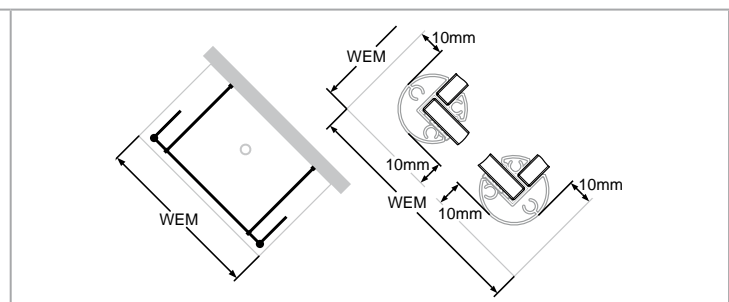
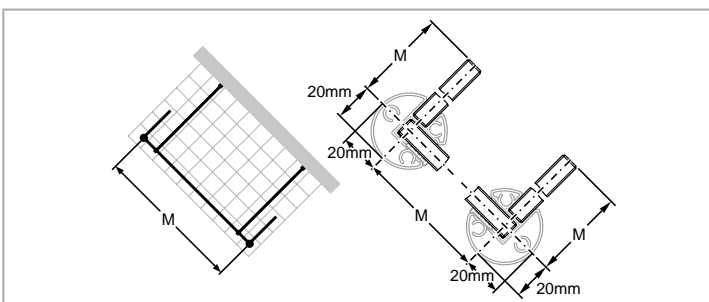

HÜPPE Studio Paris elegance partially framed Rectangular HÜPPE Studio Berlin pure partially framed Rectangular

Walk-In model 1

Made-to-measure

Height	Width SW B2	Width SW B1	Width SW B3	PARIS	BERLIN	Base price
1200-2000	300-600	1200-1800	300-600	PT0709	BT0709	2.428,-
2001-2200	300-600	1200-1800	300-600	PT070E	BT070E	2.775,-

Dim. Range: min. - max.

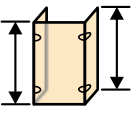
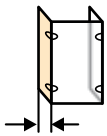
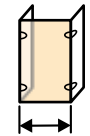
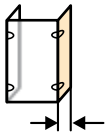
			
1200-2200	300-600	1200-1800	300-600

Special options

Optional variants		Extra charges
Design profile with ceiling connection. Ceiling connection min. 160mm	702	213,-
Narrow side panel movable	720	393,-
Ceiling connection and narrow side panel movable	721	604,-
Towel rail (high-gloss silver as standard, towel rail in black for Black Edition systems)	T99	210,-
Towel rail and ceiling connection. Ceiling connection min. 160mm.	T02	423,-
Towel rail and narrow side panel movable	T20	603,-
Towel rail, ceiling connection and narrow side panel, movable	T21	814,-

Colours - Panel options

Basic colours	Colour code	Extra charges	Panel options	without Anti-Plaque		with Anti-Plaque	
				Glass code	Extra charges	Glass code	Extra charges
High-grade matt chrome/high-grade matt chrome	E05	0,-	Clear	321	0,-	322	209,-
Black Edition	123	171,-	Karo	311	186,-	312	395,-
Chrome/chrome	C91	303,-	Sand Plus	315		316	
Individual RAL colours	998	388,-	Privatima	373		375	
			Mirror glass	380	439,-	381	648,-

**Further panel options HÜPPE Studio Paris elegance/
HÜPPE Studio Berlin pure - see chapter intro.**

HÜPPE Studio Paris elegance partially framed Rectangular

HÜPPE Studio Berlin pure partially framed Rectangular

HÜPPE Studio Paris elegance

HÜPPE Studio Berlin pure

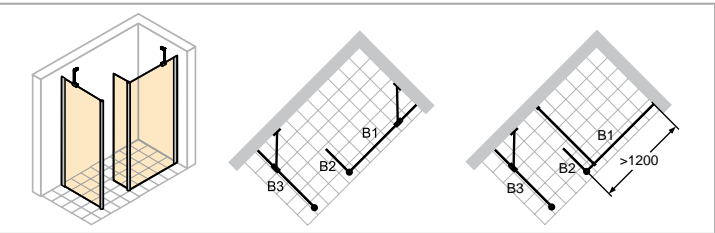
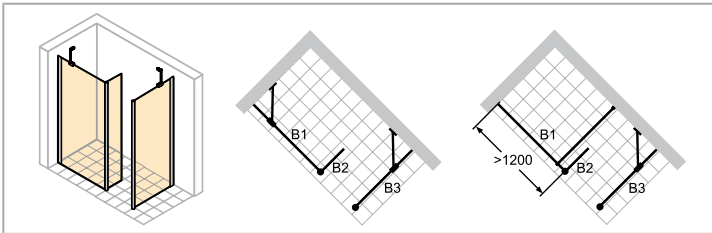
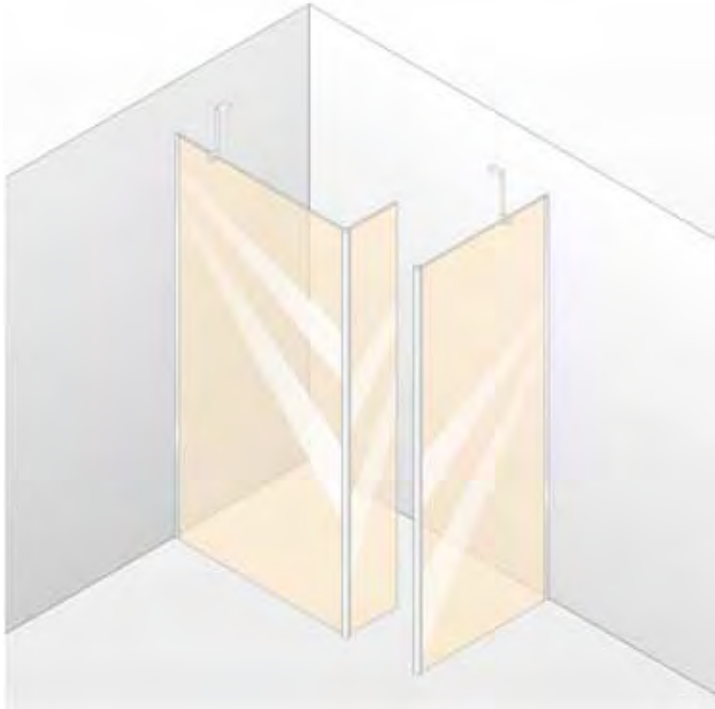
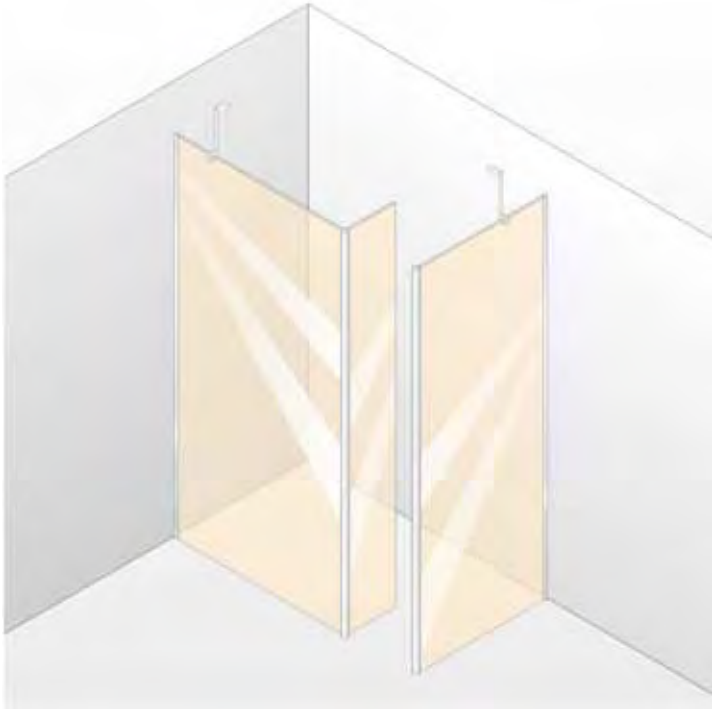

Left-hand fixing

Right-hand fixing

- Price including slopes and cut-outs.
- Walk-In parts have no inlays, therefore supplied in basic colour.
- Mirror glass (380/381): Please state in your order which segment should be produced with mirror glass. If this is not stated, the entire unit will be produced with mirror glass.
- For technical information, see Profile Colours and Panel Options section.
- Towel rail height can be selected individually and must be specified with the order. If nothing is specified, the towel rail is always delivered middle of glass (height and width).

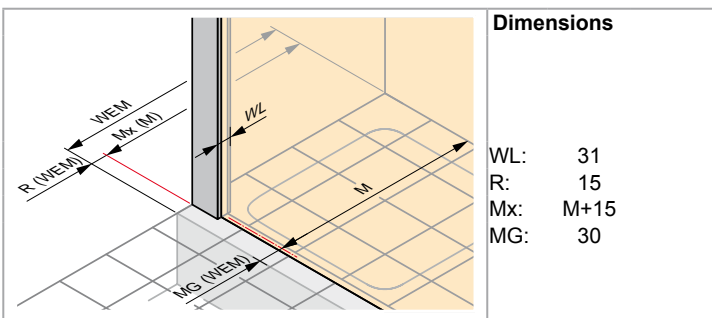

WEM = Tray installation dim. (000)
M = installation dimension Centre glass (001)
Please always specify when ordering.

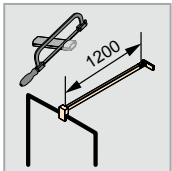
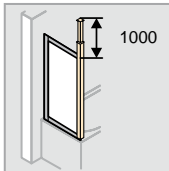
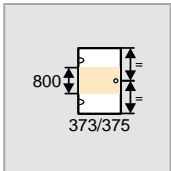
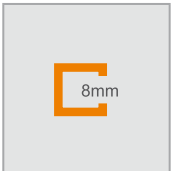
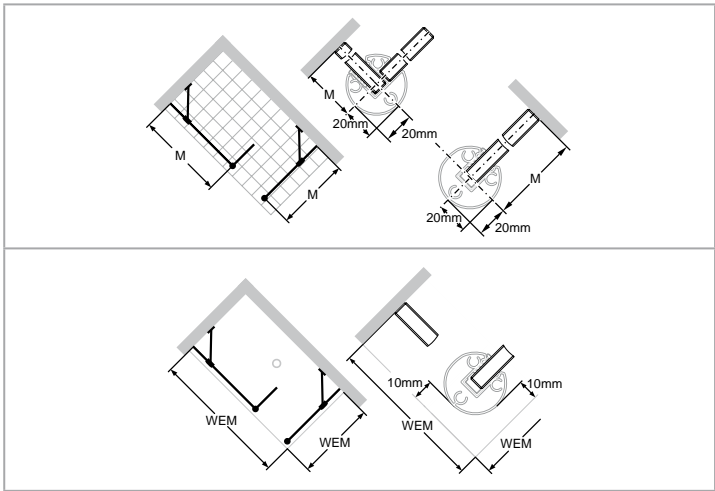

HÜPPE Studio Paris elegance partially framed Rectangular

HÜPPE Studio Berlin pure partially framed Rectangular

Walk-In model 2

Made-to-measure - Left-hand fixing

Height	Width SW B1	Width SW B2	Width SW B3	PARIS	BERLIN	Base price
1200-2000	300-1200	300-600	300-1200	PT0719	BT0719	2.428,-
	300-1200	300-600	1201-1800	PT071E	BT071E	2.822,-
	1201-1800	300-600	300-1200	PT071F	BT071F	3.214,-
2001-2200	1201-1800	300-600	1201-1800	PT071G	BT071G	2.775,-
	300-1200	300-600	300-1200	PT071H	BT071H	3.168,-
	300-1200	300-600	1201-1800	PT071J	BT071J	3.562,-

Made-to-measure - Right-hand fixing

Height	Width SW B1	Width SW B2	Width SW B3	PARIS	BERLIN	Base price
1200-2000	300-1200	300-600	300-1200	PT0729	BT0729	2.428,-
	300-1200	300-600	1201-1800	PT072E	BT072E	2.822,-
	1201-1800	300-600	300-1200	PT072F	BT072F	3.214,-
2001-2200	1201-1800	300-600	1201-1800	PT072G	BT072G	2.775,-
	300-1200	300-600	300-1200	PT072H	BT072H	3.168,-
	300-1200	300-600	1201-1800	PT072J	BT072J	3.562,-

Dim. Range: min. - max.

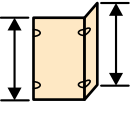
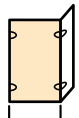
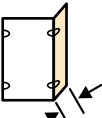
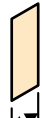
			
1200-2200	300-1800	300-600	300-1800

Special options

Optional variants		Extra charges
Design profile with ceiling connection. Ceiling connection min. 160mm	702	213,-
Narrow side panel movable	720	393,-
Ceiling connection and narrow side panel movable	721	604,-
Towel rail (high-gloss silver as standard, towel rail in black for Black Edition systems)	T99	210,-
Towel rail and ceiling connection. Ceiling connection min. 160mm.	T02	423,-
Towel rail and narrow side panel movable	T20	603,-
Towel rail, ceiling connection and narrow side panel, movable	T21	814,-

Colours - Panel options

Basic colours	Colour code	Extra charges	Panel options	without Anti-Plaque		with Anti-Plaque	
				Glass code	Extra charges	Glass code	Extra charges
High-grade matt chrome/high-grade matt chrome	E05	0,-	Clear	321	0,-	322	209,-
Black Edition	123	171,-	Karo	311	186,-	312	395,-
Chrome/chrome	C91	303,-	Sand Plus	315		316	
Individual RAL colours	998	388,-	Privatima	373		375	
			Mirror glass	380	439,-	381	648,-

Further panel options HÜPPE Studio Paris elegance/
HÜPPE Studio Berlin pure - see chapter intro.

HÜPPE Studio Paris elegance partially framed Rectangular

HÜPPE Studio Berlin pure partially framed Rectangular

HÜPPE Studio Paris elegance

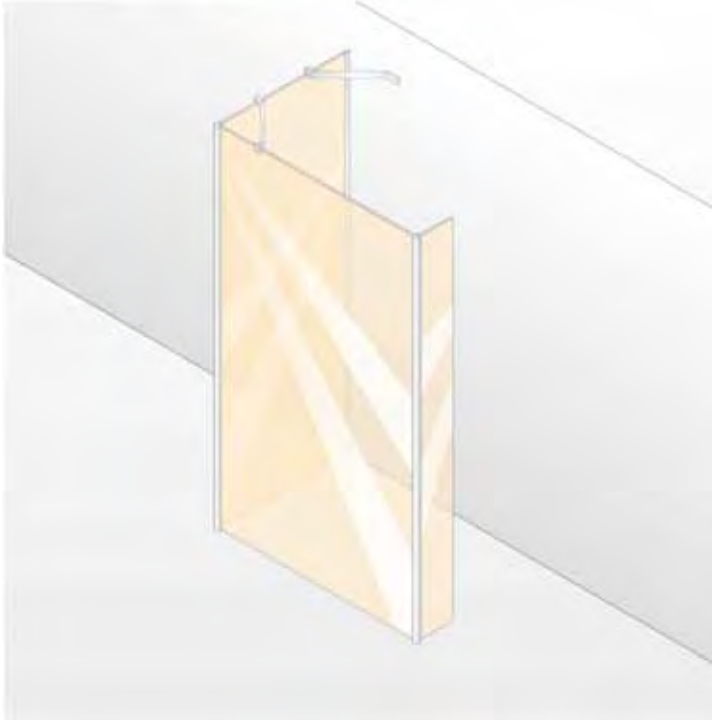

HÜPPE Studio Berlin pure

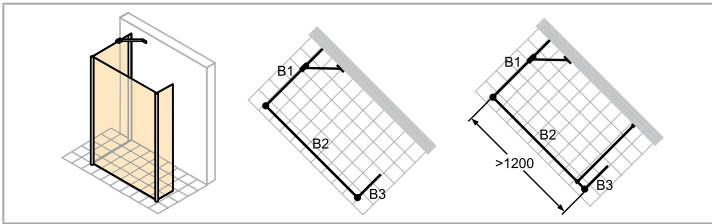
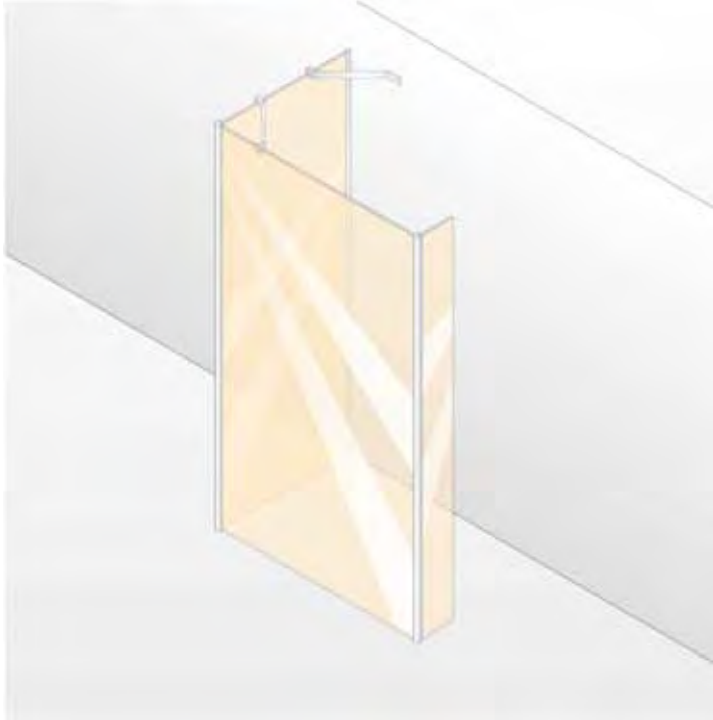

Left-hand fixing

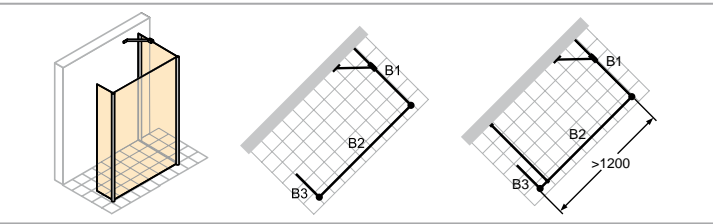

Right-hand fixing

- Price including slopes and cut-outs.
- Walk-In parts have no inlays, therefore supplied in basic colour.
- Mirror glass (380/381): Please state in your order which segment should be produced with mirror glass. If this is not stated, the entire unit will be produced with mirror glass.
- For technical information, see Profile Colours and Panel Options section.
- Towel rail height can be selected individually and must be specified with the order. If nothing is specified, the towel rail is always delivered middle of glass (height and width).

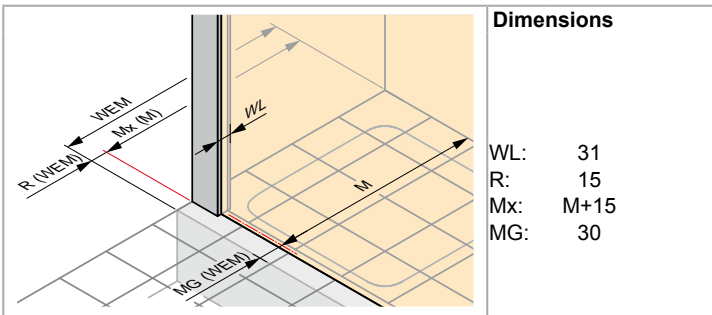

WEM = Tray installation dim. (000)
M = installation dimension Centre glass (001)
Please always specify when ordering.

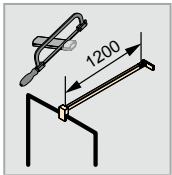
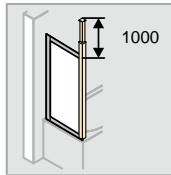
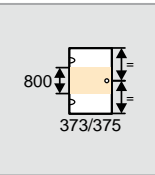
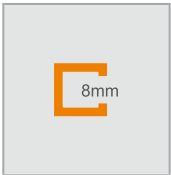
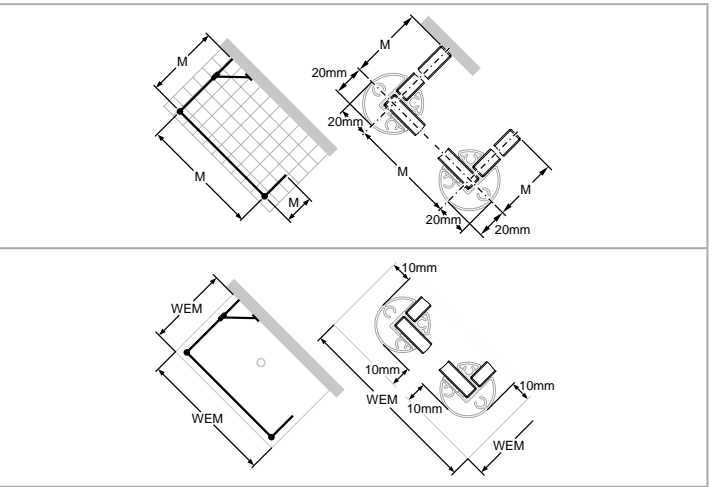

HÜPPE Studio Paris elegance partially framed Rectangular

HÜPPE Studio Berlin pure partially framed Rectangular

Walk-In model 3

Made-to-measure - Left-hand fixing

Height	Width SW B1	Width SW B2	Width SW B3	PARIS	BERLIN	Base price
1200-2000	300-1200	300-1200	300-600	PT0739	BT0739	2.428,-
	300-1200	1201-1800	300-600	PT073E	BT073E	2.822,-
	1201-1800	300-1200				
2001-2200	1201-1800	1201-1800	300-600	PT073F	BT073F	3.214,-
	300-1200	300-1200	300-600	PT073G	BT073G	2.775,-
	300-1200	1201-1800	300-600	PT073H	BT073H	3.168,-
	1201-1800	300-1200				
1201-1800	1201-1800	300-600	PT073J	BT073J	3.562,-	

Made-to-measure - Right-hand fixing

Height	Width SW B1	Width SW B2	Width SW B3	PARIS	BERLIN	Base price
1200-2000	300-1200	300-1200	300-600	PT0749	BT0749	2.428,-
	300-1200	1201-1800	300-600	PT074E	BT074E	2.822,-
	1201-1800	300-1200				
2001-2200	1201-1800	1201-1800	300-600	PT074F	BT074F	3.214,-
	300-1200	300-1200	300-600	PT074G	BT074G	2.775,-
	300-1200	1201-1800	300-600	PT074H	BT074H	3.168,-
	1201-1800	300-1200				
1201-1800	1201-1800	300-600	PT074J	BT074J	3.562,-	

Dim. Range: min. - max.

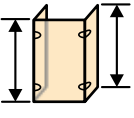
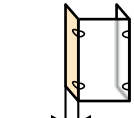
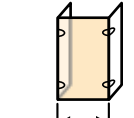
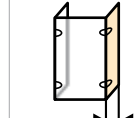
			
1200-2200	300-1800	300-1800	300-600

Special options

Optional variants		Extra charges
Design profile with ceiling connection. Ceiling connection min. 160mm	702	213,-
Narrow side panel movable	720	393,-
Ceiling connection and narrow side panel movable	721	604,-
Towel rail (high-gloss silver as standard, towel rail in black for Black Edition systems)	T99	210,-
Towel rail and ceiling connection. Ceiling connection min. 160mm.	T02	423,-
Towel rail and narrow side panel movable	T20	603,-
Towel rail, ceiling connection and narrow side panel, movable	T21	814,-

Colours - Panel options

Basic colours	Colour code	Extra charges	Panel options	without Anti-Plaque		with Anti-Plaque	
				Glass code	Extra charges	Glass code	Extra charges
High-grade matt chrome/high-grade matt chrome	E05	0,-	Clear	321	0,-	322	209,-
Black Edition	123	171,-	Karo	311	186,-	312	395,-
Chrome/chrome	C91	303,-	Sand Plus	315		316	
Individual RAL colours	998	388,-	Privatima	373		375	
			Mirror glass	380	439,-	381	648,-

Further panel options HÜPPE Studio Paris elegance/
HÜPPE Studio Berlin pure - see chapter intro.

HÜPPE Studio Paris elegance partially framed Rectangular
HÜPPE Studio Berlin pure partially framed Rectangular

HÜPPE Studio Paris elegance



HÜPPE Studio Berlin pure

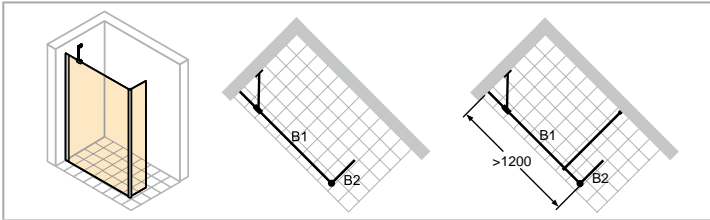

Left-hand fixing

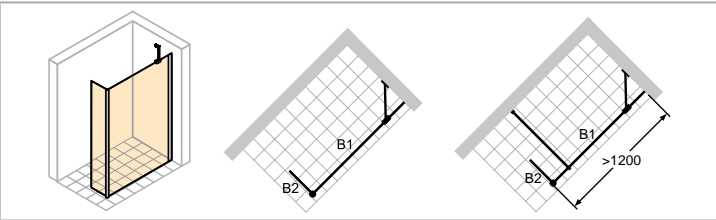

Right-hand fixing

- Price including slopes and cut-outs.
- Walk-In parts have no inlays, therefore supplied in basic colour.
- Mirror glass (380/381): Please state in your order which segment should be produced with mirror glass. If this is not stated, the entire unit will be produced with mirror glass.
- For technical information, see Profile Colours and Panel Options section.
- Towel rail height can be selected individually and must be specified with the order. If nothing is specified, the towel rail is always delivered middle of glass (height and width).

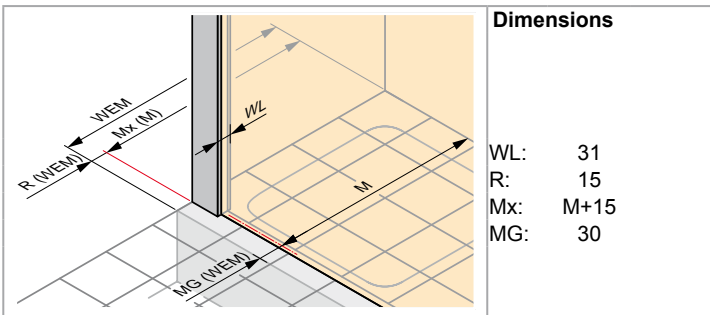

WEM = Tray installation dim. (000)
M = installation dimension Centre glass (001)
Please always specify when ordering.

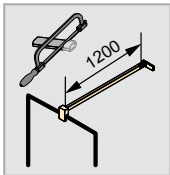
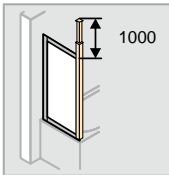
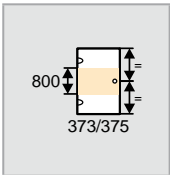
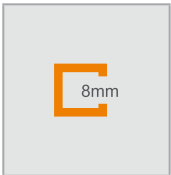
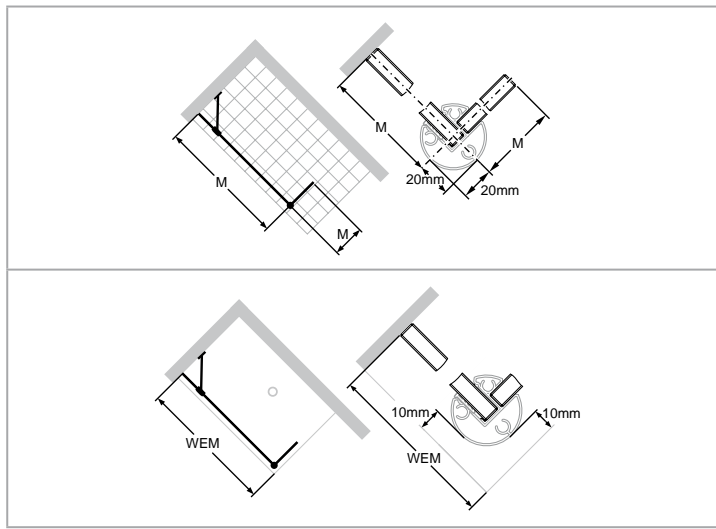

HÜPPE Studio Paris elegance partially framed Rectangular

HÜPPE Studio Berlin pure partially framed Rectangular

Walk-In model 4

Made-to-measure - Left-hand fixing

Height	Width SW B1	Width SW B2	PARIS	BERLIN	Base price
1200-2000	300-1200	300-600	PT0759	BT0759	1.159,-
	1201-1800	300-600	PT075E	BT075E	1.553,-
2001-2200	300-1200	300-600	PT075F	BT075F	1.506,-
	1201-1800	300-600	PT075G	BT075G	1.899,-

Made-to-measure - Right-hand fixing

Height	Width SW B1	Width SW B2	PARIS	BERLIN	Base price
1200-2000	300-1200	300-600	PT0769	BT0769	1.159,-
	1201-1800	300-600	PT076E	BT076E	1.553,-
2001-2200	300-1200	300-600	PT076F	BT076F	1.506,-
	1201-1800	300-600	PT076G	BT076G	1.899,-

Dim. Range: min. - max.

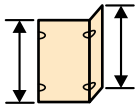
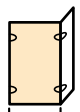
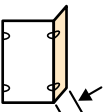
		
1200-2200	300-1800	300-600

Special options

Optional variants		Extra charges
Design profile with ceiling connection. Ceiling connection min. 160mm	702	213,-
Narrow side panel movable	720	393,-
Ceiling connection and narrow side panel movable	721	604,-
Towel rail (high-gloss silver as standard, towel rail in black for Black Edition systems)	T99	210,-
Towel rail and ceiling connection. Ceiling connection min. 160mm.	T02	423,-
Towel rail and narrow side panel movable	T20	603,-
Towel rail, ceiling connection and narrow side panel, movable	T21	814,-

Colours - Panel options

Basic colours	Colour code	Extra charges	Panel options	without Anti-Plaque		with Anti-Plaque	
				Glass code	Extra charges	Glass code	Extra charges
High-grade matt chrome/high-grade matt chrome	E05	0,-	Clear	321	0,-	322	209,-
Black Edition	123	171,-	Karo	311	186,-	312	395,-
Chrome/chrome	C91	177,-	Sand Plus	315		316	
Individual RAL colours	998	303,-	Privatima	373		375	
			Mirror glass	380	439,-	381	648,-

Further panel options HÜPPE Studio Paris elegance/
HÜPPE Studio Berlin pure - see chapter intro.

HÜPPE Bath-top shower screens



HÜPPE Bath-top shower screens model overview - Base price

HÜPPE Xtensa pure

Sliding door, 1-panel with fixed segment

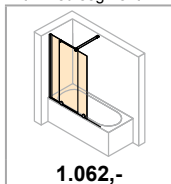

1.062,-

T.2-T.3

HÜPPE Design elegance/HÜPPE Design pure

1-panel

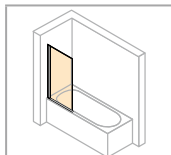

366,-

T.4-T.5

1-panel with fixed segment

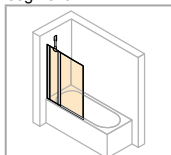

541,-

T.6-T.7

Folding swing door

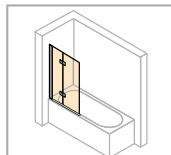

737,-

T.8-T.9

3-panel

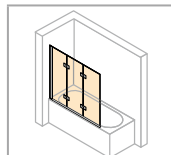

822,-

T.10-T.11

Side panel

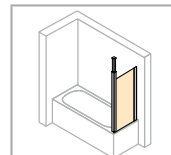

423,-

T.12-T.13

HÜPPE 501 Design pure

1-panel

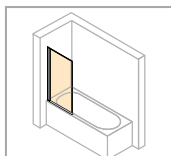

366,-

T.14-T.15

1-panel with fixed segment

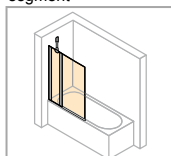

541,-

T.16-T.17

Folding swing door

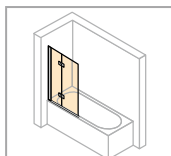

737,-

T.18-T.19

Side panel

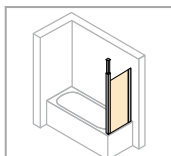

423,-

T.20-T.21

HÜPPE Combinett 2

2-panel

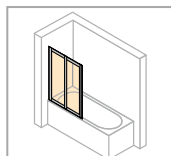

362,-

T.22-T.23

3-panel

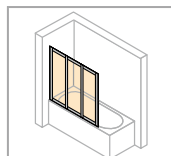

415,-

T.22-T.23

3-panel with larger 1st panel

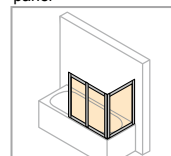

453,-

T.24-T.25

Side panel

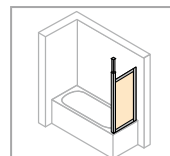

375,-

T.26-T.27

HÜPPE Solva pure frameless

1-panel

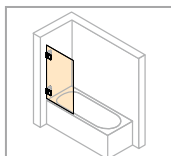

914,-

T.28-T.29

1-panel with fixed segment

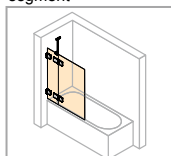

1.372,-

T.30-T.31

Folding swing door

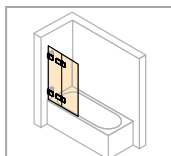

1.511,-

T.32-T.33

HÜPPE Solva pure partially framed

1-panel

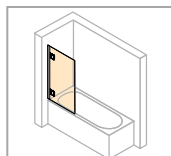

721,-

T.34-T.35

1-panel with fixed segment

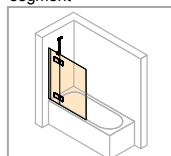

1.080,-

T.36-T.37

Folding swing door

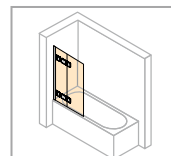

1.189,-

T.38-T.39

HÜPPE Studio Paris elegance frameless

HÜPPE Studio Berlin pure frameless

1-panel

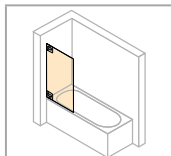

874,-

T.40-T.41

1-panel with fixed segment

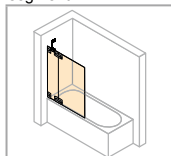

1.452,-

T.42-T.43

HÜPPE Studio Paris elegance partially framed

HÜPPE Studio Berlin pure partially framed

1-panel

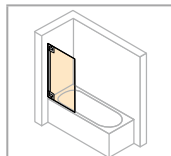

874,-

T.44-T.45

1-panel with fixed segment

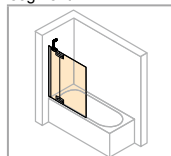

1.452,-

T.46-T.47

Bath-top shower screens

HÜPPE Xtensa pure Bath-top shower screen

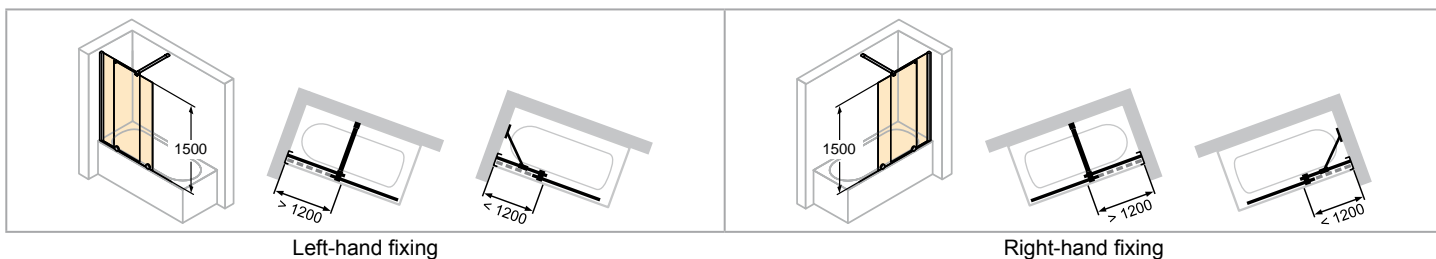
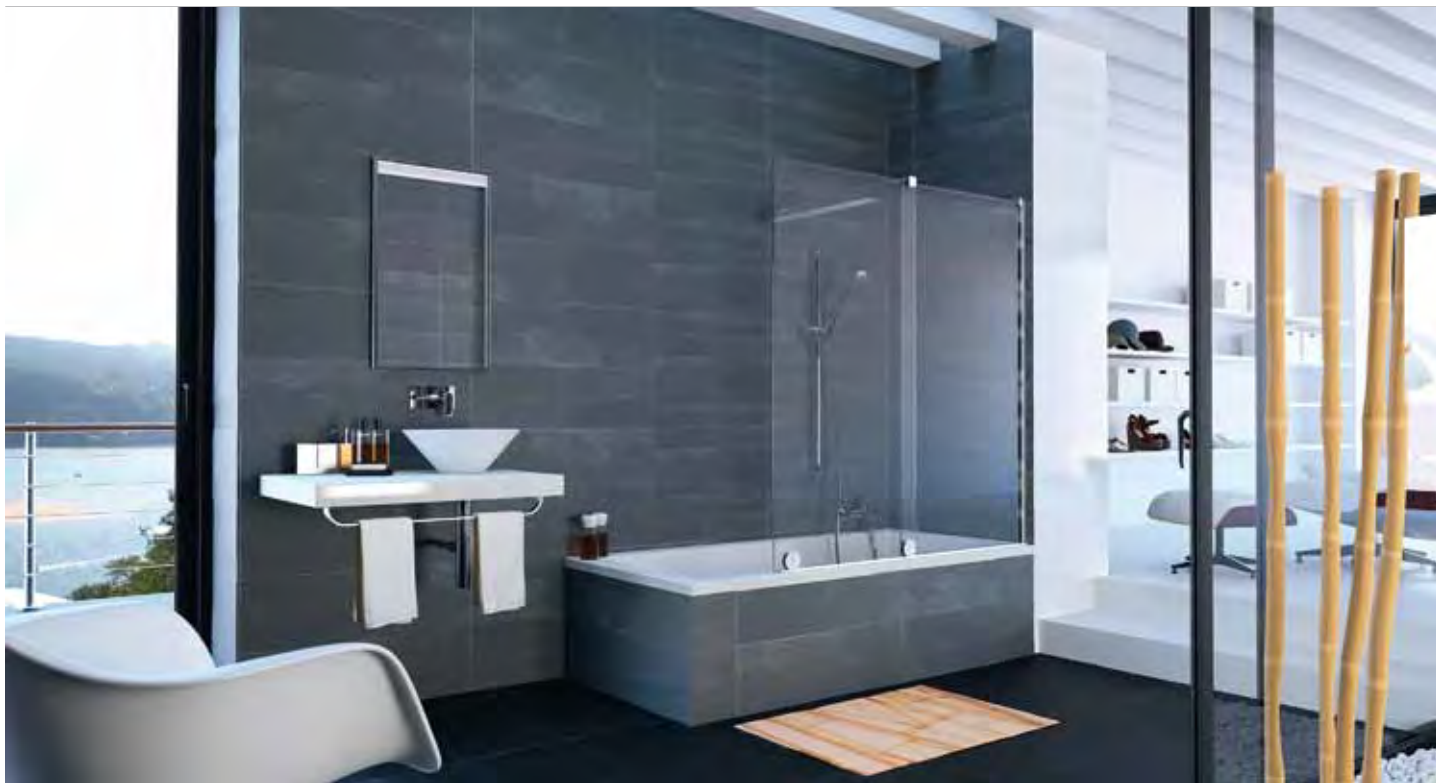

Left-hand fixing

Right-hand fixing

- An even/flat area of 50mm must be available.
- Installation on tiled surfaces and shower trays possible. Minimum tray rim width or floor area required for installation: 50mm.
- T-solution supplement set as an alternative to cross-bracing, see chapter Accessories and others.
- Mirror glass (380/381): Please state in your order which segment should be produced with mirror glass. If this is not stated, the entire unit will be produced with mirror glass.
- For technical information, see Profile Colours and Panel Options section.
- Product is delivered without handle as standard.

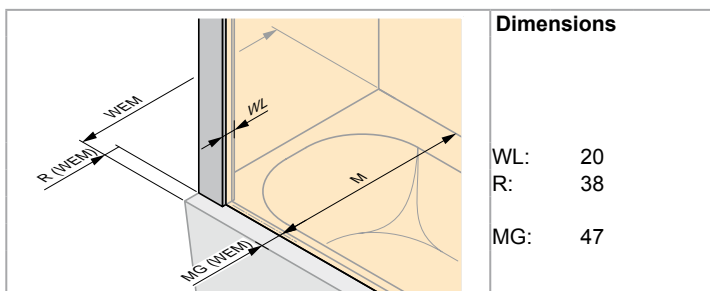

WEM = Tray installation dim. (000)
M = installation dimension Centre glass (001)
Please always specify when ordering.

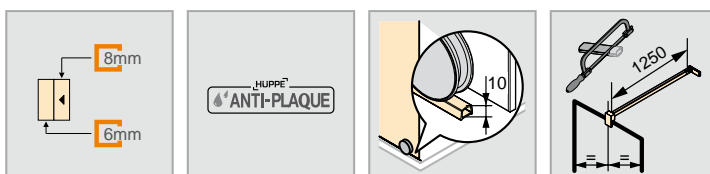
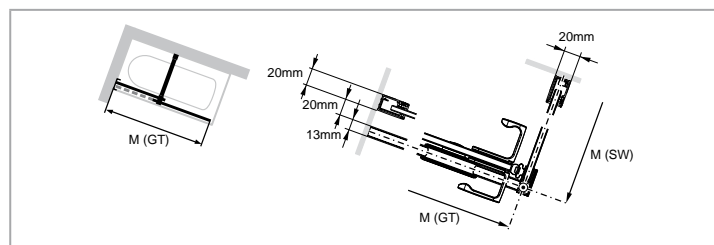

Sliding door, 1-panel with fixed segment

Left-hand fixing

Height	Width	Min-max overlap glass panels X	Min. max. entry width with side panel	Fixing	Product no.	Base price
1500	1101-1200	91-190	403-502	Stabilizer	XT0601	1.062,-
	1201-1400	91-290	403-602	Cross-bracing	XT0602	1.230,-

Made-to-measure - Left-hand fixing

Height	Width	Product no.	Base price
1200-1500	700-1400	XT0680	1.599,-

Right-hand fixing

Height	Width	Min-max overlap glass panels X	Min. max. entry width with side panel	Fixing	Product no.	Base price
1500	1101-1200	91-190	403-502	Stabilizer	XT0701	1.062,-
	1201-1400	91-290	403-602	Cross-bracing	XT0702	1.230,-

Made-to-measure - Right-hand fixing

Height	Width	Product no.	Base price
1200-1500	700-1400	XT0780	1.599,-

Dim. Range: min. - max.

1200-1500	700-1400	390-1040	380-1040

Special options

Optional variants		Extra charges
Comfort handle Xtensa	792	88,-
Ceiling connection 80-600mm	791	119,-
Comfort handle Xtensa and ceiling connection Xtensa 80-600mm	793	207,-

Colours - Panel options

Profile colours	Colour code	Extra charges	Panel options		without Anti-Plaque		with Anti-Plaque	
			Glass code	Extra charges	Glass code	Extra charges		
Silver high-gloss	069	0,-	Clear	321	0,-	322	209,-	
Black Edition	123	171,-	Grey	301		368		
			Bronze	341	186,-	378	395,-	
			Sand Plus	315		316		
			Mirror glass	380	439,-	381	648,-	

HÜPPE Design elegance Bath-top shower screen

HÜPPE Design pure Bath-top shower screen

elegance

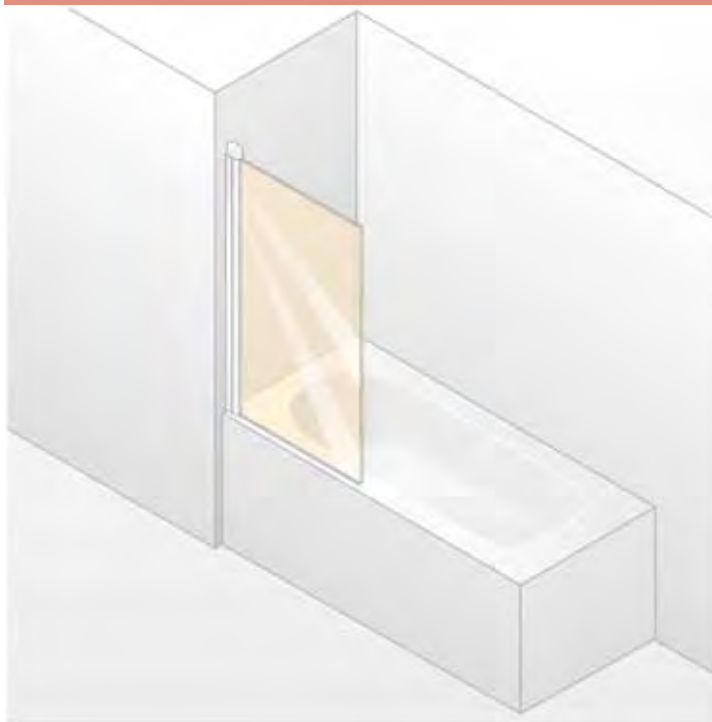

pure

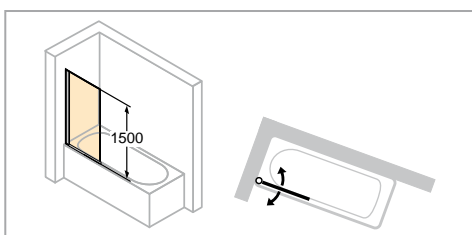

- Towel rail height can be selected individually and must be specified with the order. If nothing is specified, the towel rail is always delivered middle of glass (height and width).
- Cover cap, drip deflector strip always in silver high-gloss, except with the Black Edition.

elegance

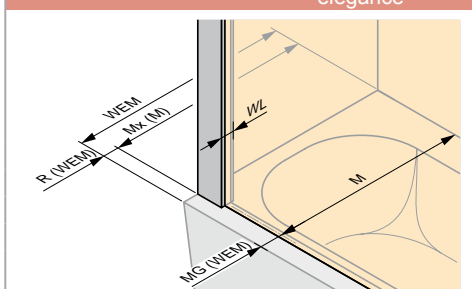

Dimensions

WL: 28
R: 15
Mx: M+15
MG: 30

WEM = Tray installation dim. (000)
M = installation dimension Centre glass (001)
Please always specify when ordering.

pure

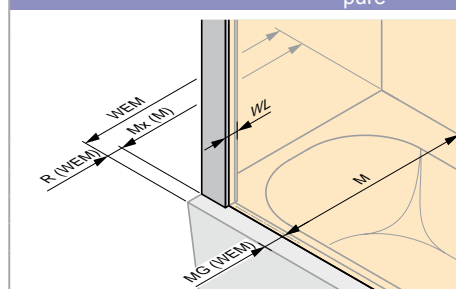

Dimensions

WL: 30
R: 15
Mx: M+15
MG: 30

WEM = Tray installation dim. (000)
M = installation dimension Centre glass (001)
Please always specify when ordering.

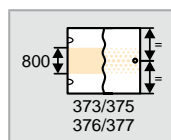
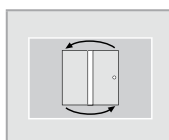
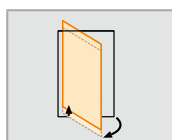
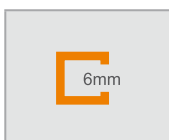

HÜPPE Design elegance Bath-top shower screen

HÜPPE Design pure Bath-top shower screen

1-panel



Height	Width of 1st panel	Total width	elegance	pure	Base price
1500	730	750-765	8E1901	8P1901	366,-

Made-to-measure

Height	Width	elegance	pure	Base price
to 1500	500-1000	8E1980	8P1980	476,-

Adjustment range = dimensions - 8mm / + 7mm

Dim. Range: min. - max.

	
to 1500	500-1000

Special options

Optional variants		Extra charges
Towel rail (high-gloss silver as standard, towel rail in black for Black Edition systems)	T99	210,-

Colours - Panel options

Profile colours	Colour code	Extra charges
White	055	0,-
Matt silver	087	
Black	023	
Grey/brown	061	
Silver high-gloss	092	

HÜPPE Design pure

Profile colours	Colour code	Extra charges
Black Edition	123	171,-

Panel options	without Anti-Plaque		with Anti-Plaque	
	Glass code	Extra charges	Glass code	Extra charges
Clear	321	0,-	322	209,-
Grey	301	186,-	368	395,-
Bronze	341		378	
Sand Plus	315		316	
Privatima	373		375	
Bubbles	376		377	
Mirror glass	380	439,-	381	648,-

HÜPPE Design elegance Bath-top shower screen

HÜPPE Design pure Bath-top shower screen

elegance

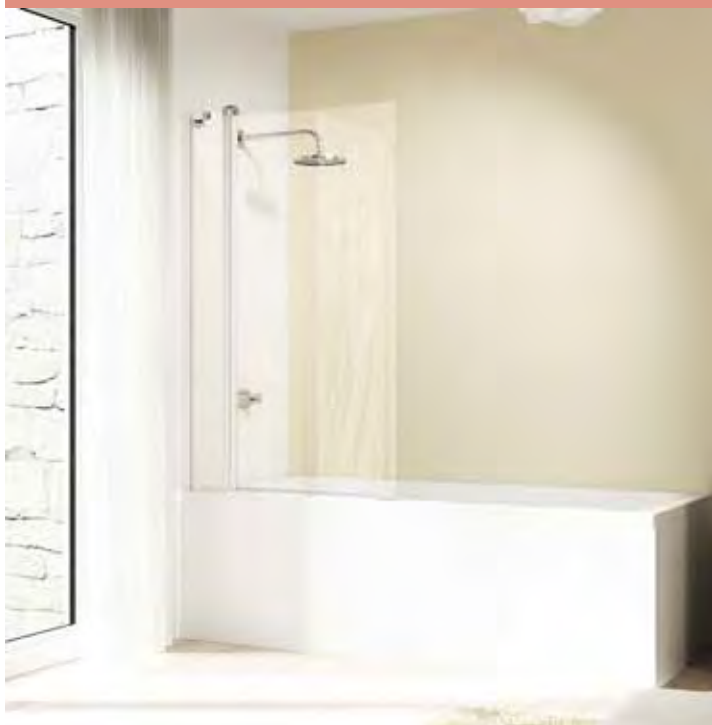

pure

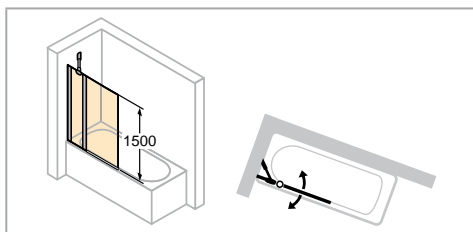

Glass 373/375 Privatima: Specification in the order whether left-hand or right-hand fixing.

- Mirror glass (380/381): Please state in your order which segment should be produced with mirror glass. If this is not stated, the entire unit will be produced with mirror glass.
- For technical information, see Profile Colours and Panel Options section.
- Stabilizer, cover cap, drip deflector strip always in silver high-gloss, except with the Black Edition.

	<p>Dimensions</p> <p>WL: 24 R: 20 Mx: M+10 MG: 30</p>
<p>WEM = Tray installation dim. (000) M = installation dimension Centre glass (001) Please always specify when ordering.</p>	

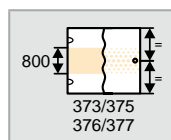
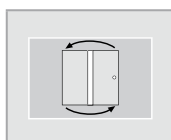
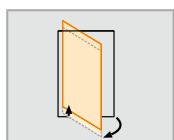
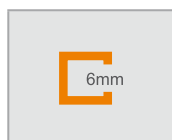

HÜPPE Design elegance Bath-top shower screen

HÜPPE Design pure Bath-top shower screen

1-panel with fixed segment

Height	Width of 1st panel	Width of 2nd panel	Total width	elegance	pure	Base price
1500	220	730	950-965	8E2001	8P2001	541,-

Made-to-measure

Height	Width	elegance	pure	Base price
to 1500	700-1550	8E2080	8P2080	703,-

Adjustment range = dimensions - 8mm / + 7mm

Dim. Range: min. - max.

to 1500	700-1550	220-650	max. 900

Colours - Panel options

Profile colours	Colour code	Extra charges
White	055	0,-
Matt silver	087	
Black	023	156,-
Grey/brown	061	
Silver high-gloss	092	

HÜPPE Design pure

Profile colours	Colour code	Extra charges
Black Edition	123	171,-

Panel options	without Anti-Plaque		with Anti-Plaque	
	Glass code	Extra charges	Glass code	Extra charges
Clear	321	0,-	322	209,-
Grey	301	186,-	368	395,-
Bronze	341		378	
Sand Plus	315		316	
Privatima	373		375	
Bubbles	376		377	
Mirror glass	380	439,-	381	648,-

HÜPPE Design elegance Bath-top shower screen
HÜPPE Design pure Bath-top shower screen

elegance



pure

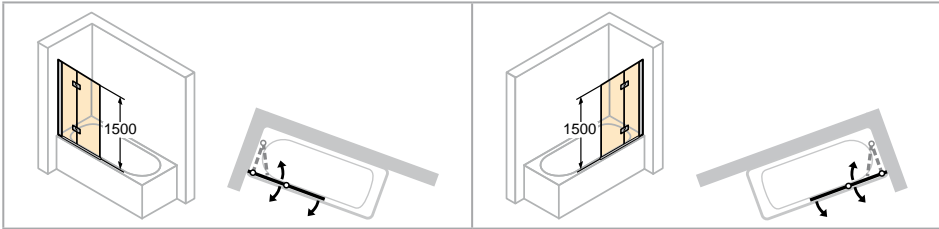

Left-hand fixing

Right-hand fixing

- Mirror glass (380/381): Please state in your order which segment should be produced with mirror glass. If this is not stated, the entire unit will be produced with mirror glass.
- For technical information, see Profile Colours and Panel Options section.
- Cover cap, hinges, drip deflector strip always in silver high-gloss, except with the Black Edition.

elegance

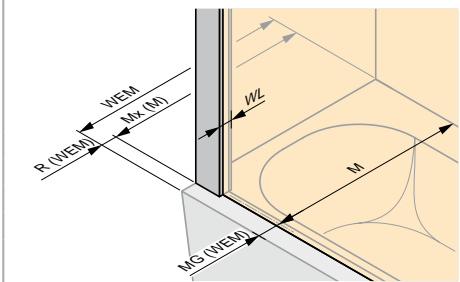

Dimensions

- WL: 28
- R: 15
- Mx: M+10
- MG: 30

WEM = Tray installation dim. (000)
M = installation dimension Centre glass (001)
Please always specify when ordering.

pure

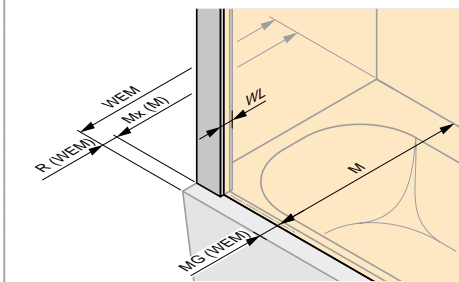

Dimensions

- WL: 30
- R: 15
- Mx: M+10
- MG: 30

WEM = Tray installation dim. (000)
M = installation dimension Centre glass (001)
Please always specify when ordering.

6mm

HÜPPE[®]
ANTI-PLAQUE

800
373/375
376/377

Folding swing door

Left-hand fixing

Height	Width	Width of 1st panel	Width of 2nd panel	elegance	pure	Base price
1500	1000	533-548	452	8E2301	8P2301	737,-
	1200	633-648	552	8E2302	8P2302	781,-

Made-to-measure - Left-hand fixing

Height	Width	elegance	pure	Base price
to 1500	to 1200	8E2380	8P2380	957,-

Adjustment range = dimensions - 8mm / + 7mm

Right-hand fixing

Height	Width	Width of 1st panel	Width of 2nd panel	elegance	pure	Base price
1500	1000	533-548	452	8E2401	8P2401	737,-
	1200	633-648	552	8E2402	8P2402	781,-

Made-to-measure - Right-hand fixing

Height	Width	elegance	pure	Base price
to 1500	to 1200	8E2480	8P2480	957,-



Adjustment range = dimensions - 8mm / + 7mm

	Model	Folded width F	Profile thickness P
	SFT 1000	510	95-110
	SFT 1200	610	95-110

Slopes and cut-outs

Slopes	Extra charges
	Supplement per slope/cut-out for made-to-measure 170,-

Dim. Range: min. - max.

	
to 1500	to 1200

Colours - Panel options

Profile colours	Colour code	Extra charges	Panel options	without Anti-Plaque		with Anti-Plaque	
				Glass code	Extra charges	Glass code	Extra charges
White	055	0,-	Clear	321	0,-	322	209,-
Matt silver	087		Grey	301		368	
Black	023		Bronze	341		378	
Grey/brown	061		Sand Plus	315	186,-	316	395,-
Silver high-gloss	092		Privatima	373		375	
HÜPPE Design pure			Bubbles	376		377	
Profile colours	Colour code	Extra charges	Mirror glass	380	439,-	381	648,-
Black Edition	123	171,-					

HÜPPE Design elegance Bath-top shower screen

HÜPPE Design pure Bath-top shower screen

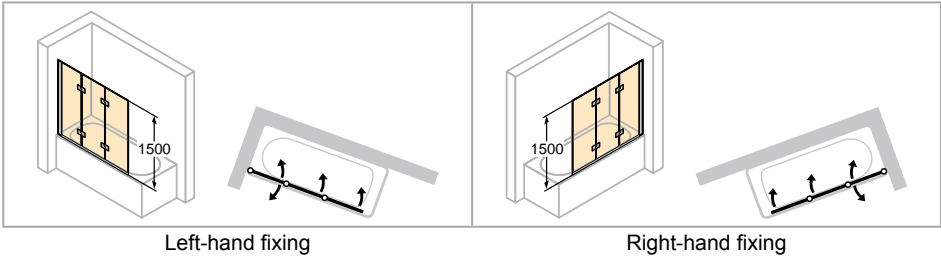
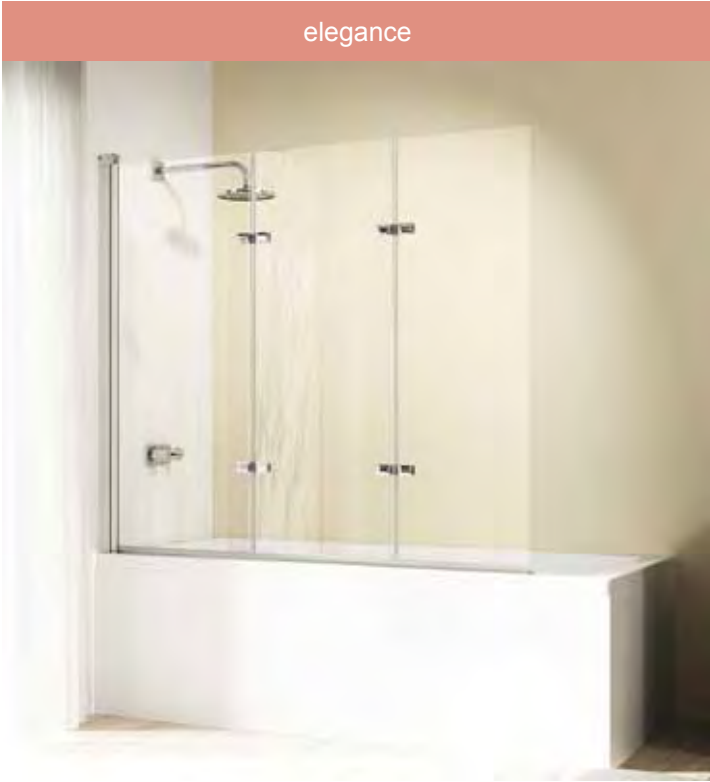

Left-hand fixing

Right-hand fixing

- Mirror glass (380/381): Please state in your order which segment should be produced with mirror glass. If this is not stated, the entire unit will be produced with mirror glass.
- For technical information, see Profile Colours and Panel Options section.
- Cover cap, hinges, drip deflector strip always in silver high-gloss, except with the Black Edition.

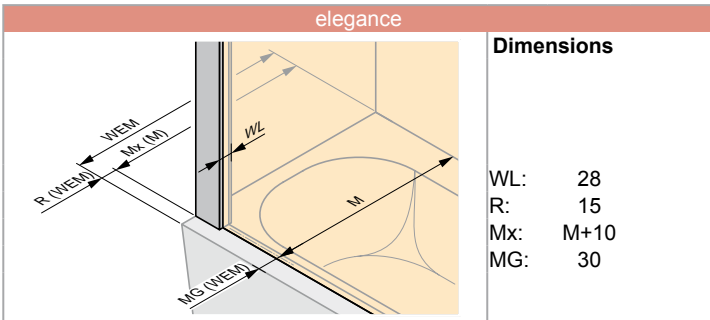

Dimensions

- WL: 28
- R: 15
- Mx: M+10
- MG: 30

WEM = Tray installation dim. (000)
 M = installation dimension Centre glass (001)
 Please always specify when ordering.

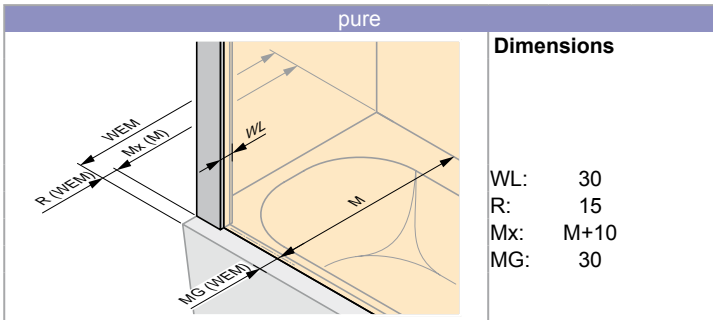

Dimensions

- WL: 30
- R: 15
- Mx: M+10
- MG: 30

WEM = Tray installation dim. (000)
 M = installation dimension Centre glass (001)
 Please always specify when ordering.

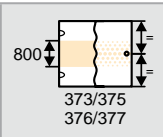
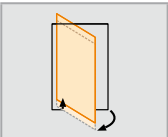
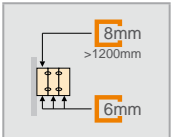

3-panel

Left-hand fixing

Height	Width of 1st panel incl. wall profile	Width of 2nd panel	Width of 3rd panel	Total width	elegance	pure	Base price
1500	492-507	393	315	1200-1215	8E6501	8P6501	822,-

Made-to-measure - Left-hand fixing

Height	Width	elegance	pure	Base price
to 1500	1000-1200	8E6580	8P6580	1.069,-
	1201-1400	8E6581	8P6581	
	1401-1600	8E6582	8P6582	

Adjustment range = dimensions - 8mm / + 7mm

Right-hand fixing

Height	Width of 1st panel incl. wall profile	Width of 2nd panel	Width of 3rd panel	Total width	elegance	pure	Base price
1500	492-507	393	315	1200-1215	8E6601	8P6601	822,-

Made-to-measure - Right-hand fixing

Height	Width	elegance	pure	Base price
to 1500	1000-1200	8E6680	8P6680	1.069,-
	1201-1400	8E6681	8P6681	
	1401-1600	8E6682	8P6682	



Adjustment range = dimensions - 8mm / + 7mm

	Model	Folded width F	Profile thickness P
	SFT 1200	472	70-85

Slopes and cut-outs

Slopes	Extra charges
	Supplement per slope/cut-out for made-to-measure 170,-

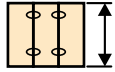
Dim. Range: min. - max.

	
to 1500	1000-1600

Colours - Panel options

Profile colours	Colour code	Extra charges
White	055	0,-
Matt silver	087	
Black	023	156,-
Grey/brown	061	
Silver high-gloss	092	

HÜPPE Design pure

Profile colours	Colour code	Extra charges
Black Edition	123	171,-

Panel options	without Anti-Plaque		with Anti-Plaque	
	Glass code	Extra charges	Glass code	Extra charges
Clear	321	0,-	322	209,-
Grey	301	186,-	368	395,-
Bronze	341		378	
Sand Plus	315		316	
Privatima	373	439,-	375	648,-
Bubbles	376		377	
Mirror glass	380		381	

HÜPPE Design elegance Bath-top shower screen

HÜPPE Design pure Bath-top shower screen

elegance



pure

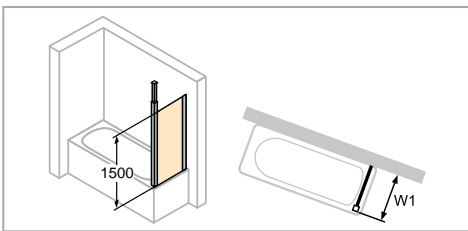

- Can be combined with every HÜPPE Design elegance and HÜPPE Design pure model.
- Towel rail height can be selected individually and must be specified with the order. If nothing is specified, the towel rail is always delivered middle of glass (height and width).

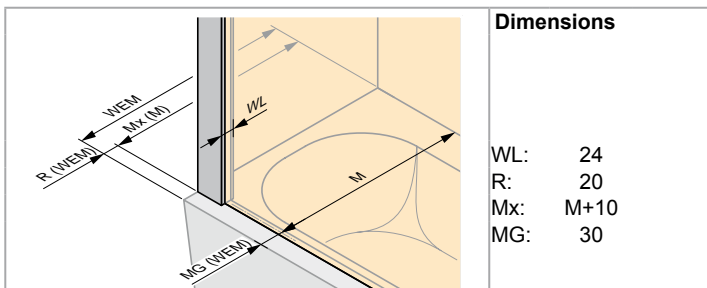

WEM = Tray installation dim. (000)
M = installation dimension Centre glass (001)
Please always specify when ordering.

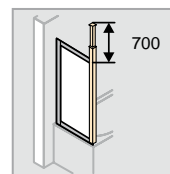
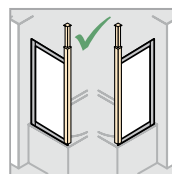
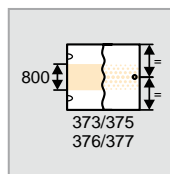
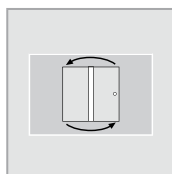
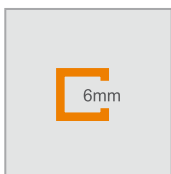

HÜPPE Design elegance Bath-top shower screen

HÜPPE Design pure Bath-top shower screen

Side panel

Height	Tray size W1	WEM	elegance	pure	Base price
1500	700	680-700	8E6801	8P6801	423,-
	750	730-750	8E6802	8P6802	

Made-to-measure



Height	Model	Total width	elegance	pure	Base price
to 1500	Corner configuration	200-1200	8E6880	8P6880	550,-
	In-line configuration	200-1200	8E6881	8P6881	

Adjustment range = dimensions - 10mm / + 10mm

Slopes and cut-outs

Slopes and cut-outs	Extra charges
 Supplement per slope/cut-out for made-to-measure	170,-

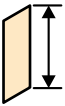
Dim. Range: min. - max.

	
to 1500	200-1200

Special options

Special options	Extra charges
Towel rail (silver high-gloss)	210,-

Extras

	elegance	pure	Price
Glass/glass brace for side panel with 2-panel bath-top shower screen	8E6901	8P6901	34,-

Colours - Panel options

Profile colours	Colour code	Extra charges
White	055	0,-
Matt silver	087	
Black	023	156,-
Grey/brown	061	
Silver high-gloss	092	

HÜPPE Design pure

Profile colours	Colour code	Extra charges
Black Edition	123	171,-

Panel options	without Anti-Plaque		with Anti-Plaque	
	Glass code	Extra charges	Glass code	Extra charges
Clear	321	0,-	322	209,-
Grey	301	186,-	368	395,-
Bronze	341		378	
Sand Plus	315		316	
Privatima	373	439,-	375	648,-
Bubbles	376		377	
Mirror glass	380		381	

HÜPPE 501 Design pure Bath-top shower screen

pure

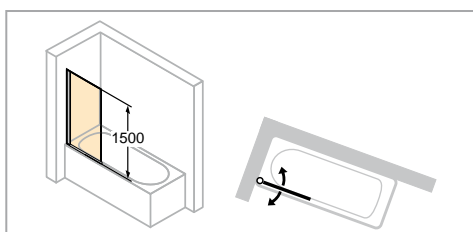
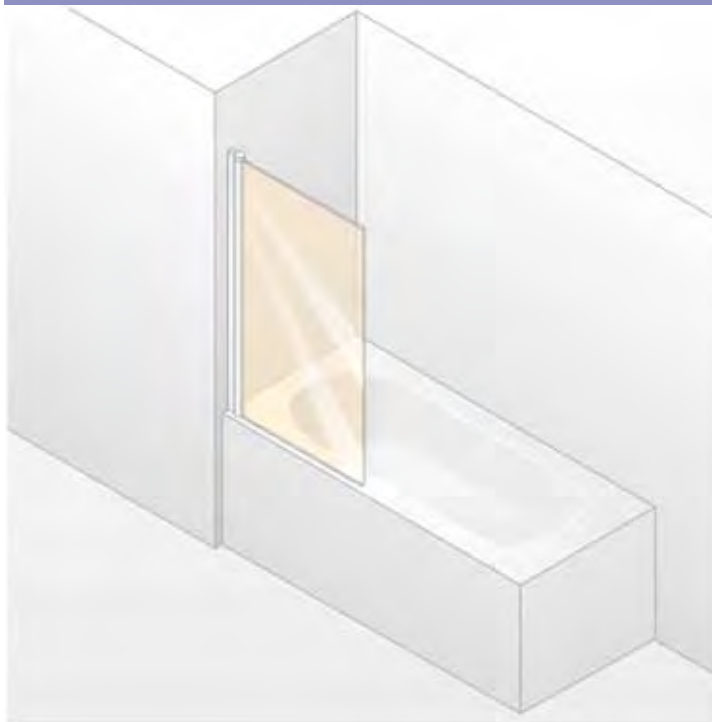

- Towel rail height can be selected individually and must be specified with the order. If nothing is specified, the towel rail is always delivered middle of glass (height and width).

	<p>Dimensions</p> <p>WL: 25 R: 15 Mx: M+13 MG: 30</p>
<p>WEM = Tray installation dim. (000) M = installation dimension Centre glass (001) Please always specify when ordering.</p>	

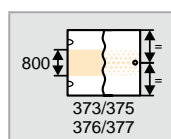
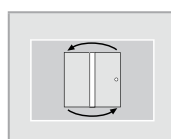
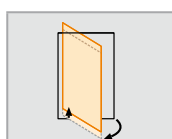
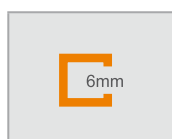

1-panel

Height	Width of 1st panel	Total width	pure	Base price
1500	730	750-765	512401	366,-

Special options

Optional variants		Extra charges
Towel rail (silver high-gloss)	T99	210,-

Colours - Panel options

Profile colours	Colour code	Extra charges	Panel options	without Anti-Plaque		with Anti-Plaque	
				Glass code	Extra charges	Glass code	Extra charges
White	055	0,-	Clear	321	0,-	322	209,-
Matt silver	087		Grey	301		368	
Black	023	156,-	Bronze	341		378	
Grey/brown	061		Sand Plus	315	186,-	316	395,-
Silver high-gloss	092		Privatima	373		375	
			Bubbles	376		377	

HÜPPE 501 Design pure Bath-top shower screen

pure

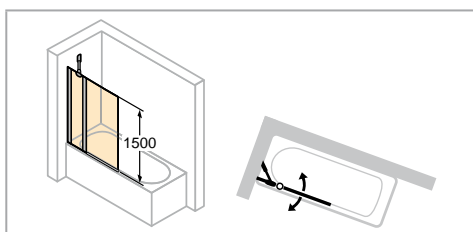

- Glass 373/375 Privatima: Specification in the order whether left-hand or right-hand fixing.

	<p>Dimensions</p> <p>WL: 25 R: 15 Mx: M+13 MG: 30</p>
<p>WEM = Tray installation dim. (000) M = installation dimension Centre glass (001) Please always specify when ordering.</p>	

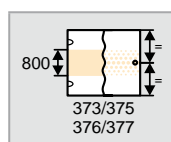
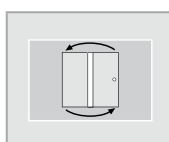
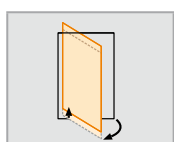
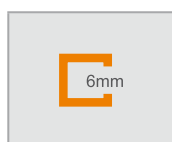

1-panel with fixed segment

Height	Width of 1st panel	Width of 2nd panel	Total width	pure	Base price
1500	220	730	950-965	512501	541,-

Colours - Panel options

Profile colours	Colour code	Extra charges
White	055	0,-
Matt silver	087	
Black	023	156,-
Grey/brown	061	
Silver high-gloss	092	

Panel options	without Anti-Plaque		with Anti-Plaque	
	Glass code	Extra charges	Glass code	Extra charges
Clear	321	0,-	322	209,-
Grey	301	186,-	368	395,-
Bronze	341		378	
Sand Plus	315		316	
Privatima	373		375	
Bubbles	376		377	

HÜPPE 501 Design pure Bath-top shower screen

pure

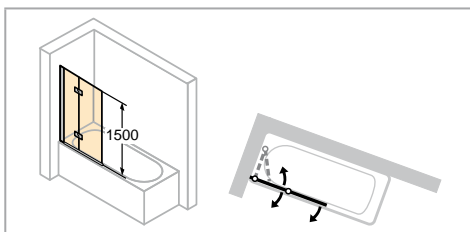

	<p>Dimensions</p> <p>WL: 25 R: 15 Mx: M+13 MG: 30</p>
<p>WEM = Tray installation dim. (000) M = installation dimension Centre glass (001) Please always specify when ordering.</p>	

<p>6mm</p>	<p>HÜPPE[®] ANTI-PLAQUE</p>		<p>800 373/375 376/377</p>
------------	--	--	------------------------------------

Folding swing door

Left-hand fixing

Height	Width	Width of 1st panel	Width of 2nd panel	pure	Base price
1500	1000	533-548	452	175230	737,-
	1200	633-648	552	175231	781,-

Made-to-measure - Left-hand fixing

Height	Width	pure	Base price
to 1500	to 1200	175239	957,-

Adjustment range = dimensions - 8mm / + 7mm

Right-hand fixing

Height	Width	Width of 1st panel	Width of 2nd panel	pure	Base price
1500	1000	533-548	452	175240	737,-
	1200	633-648	552	175241	781,-

Made-to-measure - Right-hand fixing

Height	Width	pure	Base price
to 1500	to 1200	175249	957,-



Adjustment range = dimensions - 8mm / + 7mm

	Model	Folded width F	Profile thickness P
	SFT 1000	510	95-110
	SFT 1200	610	95-110

Slopes and cut-outs

Slopes		Extra charges
	Supplement per slope/cut-out for made-to-measure	170,-

Dim. Range: min. - max.

	
to 1500	to 1200

Colours - Panel options

Profile colours	Colour code	Extra charges	Panel options	without Anti-Plaque		with Anti-Plaque	
				Glass code	Extra charges	Glass code	Extra charges
White	055	0,-	Clear	321	0,-	322	209,-
Matt silver	087		Grey	301		368	
Black	023		Bronze	341		378	
Grey/brown	061		Sand Plus	315	186,-	316	395,-
Silver high-gloss	092		Privatima	373		375	
			Bubbles	376		377	

HÜPPE 501 Design pure Bath-top shower screen

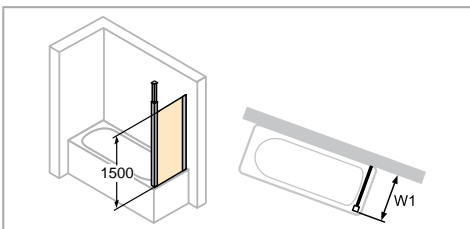

- Towel rail height can be selected individually and must be specified with the order. If nothing is specified, the towel rail is always delivered middle of glass (height and width).

	<p>Dimensions</p> <p>WL: 25 R: 12,5 Mx: M+13 MG: 30</p>
<p>WEM = Tray installation dim. (000) M = installation dimension Centre glass (001) Please always specify when ordering.</p>	

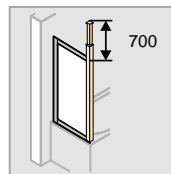
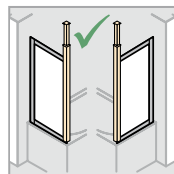
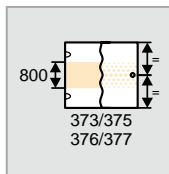
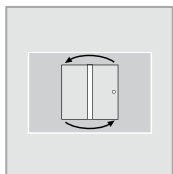
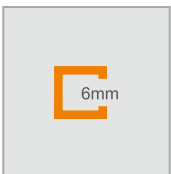

Side panel

Height	Tray size W1	WEM with side panel	pure	Base price
1500	700	680-700	512601	423,-
	750	730-750	512602	



Made-to-measure

Height	Model	Total width	pure	Base price
to 1500	Corner configuration	200-1200	512609	550,-
	In-line configuration	200-1200	512608	

Slopes and cut-outs

Slopes and cut-outs	Extra charges
 Supplement per slope/cut-out for made-to-measure	170,-

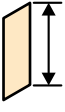
Dim. Range: min. - max.

	
to 1500	200-1200

Special options

Optional variants	pure	Extra charges
Towel rail (silver high-gloss)	T99	210,-

Extras

	pure	Extra charges
Glass/glass brace for side panel with 2-panel bath-top shower screen	510692000	34,-

Colours - Panel options

Profile colours	Colour code	Extra charges	Panel options	without Anti-Plaque		with Anti-Plaque	
				Glass code	Extra charges	Glass code	Extra charges
White	055	0,-	Clear	321	0,-	322	209,-
Matt silver	087		Grey	301		368	
Black	023	156,-	Bronze	341		378	
Grey/brown	061		Sand Plus	315	186,-	316	395,-
Silver high-gloss	092		Privatima	373		375	
			Bubbles	376		377	

HÜPPE Combinett 2 Bath-top shower screen

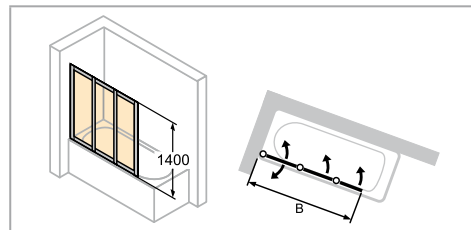
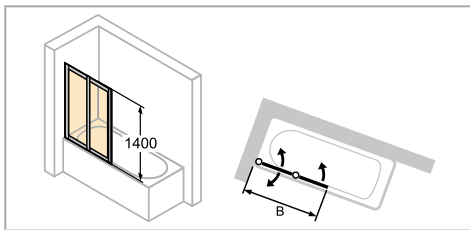

- Wall connection panel swivels in- and outwards.
- Segment seal always in grey.
- Individual width division of the segments is not possible.

Dimensions

WL: 20
R: 30
Mx: M+10
MG: 30

WEM = Tray installation dim. (000)
M = installation dimension Centre glass (001)
Please always specify when ordering.

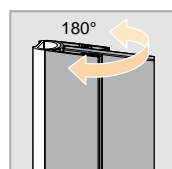
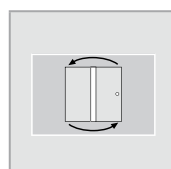
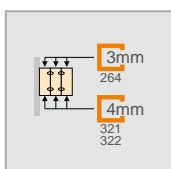
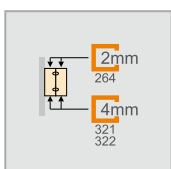

2-panel

Height	Width of 1st panel incl. wall profile	Width of 2nd panel	Total width	Folded width	Profile thickness	Product no.	Base price
1400	548-563	452	1000-1015	562	42	AC0101	362,-

Made-to-measure

Height	Width B	Product no.	Base price
1200-1500	600-1246	AC0280	487,-

Glass up to a width of 1210mm only.

Adjustment range = dimensions - 15mm / + 0mm

Dim. Range: min. - max.

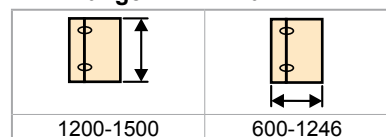

3-panel

Height	Width of 1st panel incl. wall profile	Width of 2nd panel	Width of 3rd panel	Total width	Folded width	Profile thickness	Product no.	Base price
1400	415-430	315	268	997-1012	429	53	AC0402	415,-
	548-563	448	401	1397-1412	562	53	AC0401	445,-

AC0401 only available in a styrene finish.

Made-to-measure

Height	Width B	Product no.	Base price
1200-1500	1005-1635	AC0580	563,-

Glass up to a width of 1425mm only.

Adjustment range = dimensions - 15mm / + 0mm

Dim. Range: min. - max.

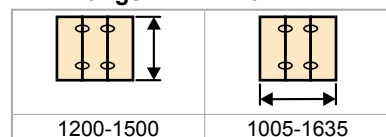

Colours - Panel options

Profile colours	Colour code	Extra charges	Panel options	without Anti-Plaque		with Anti-Plaque	
				Glass code	Extra charges	Glass code	Extra charges
White	055	0,-	Styrene Pacific S clear	264	0,-		
Matt silver	087		Clear	321	78,-	322	209,-

HÜPPE Combinett 2 Bath-top shower screen

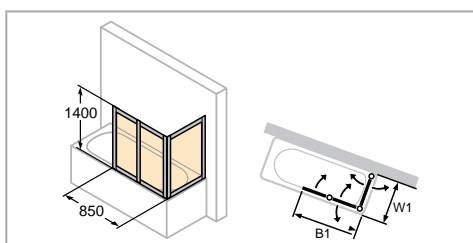

- Segment seal always in grey.

	<p>Dimensions</p> <p>WL: 20 R: 30 Mx: M+10 MG: 30</p>
<p>WEM = Tray installation dim. (000) M = installation dimension Centre glass (001) Please always specify when ordering.</p>	

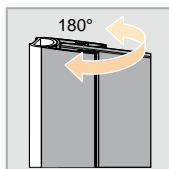
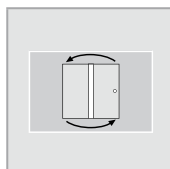
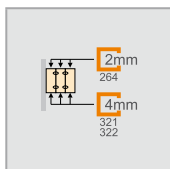

3-panel with larger 1st panel

Height	Tray size	W1 element with profile	B1	Product no.	Base price
1400	700	685-700	850	AC0701	453,-
	750	735-750	850	AC0702	

Made-to-measure

Height	Tray size	B1	Product no.	Base price
1200-1500	300-785	850	AC0880	589,-

Adjustment range = dimensions - 15mm / + 0mm

	Model	Folded width F	Profile thickness P
	700	676	53
	750	726	53

Dim. Range: min. - max.

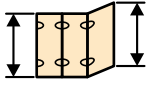
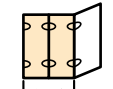
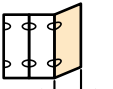
		
1200-1500	850	300-785

Colours - Panel options

Profile colours	Colour code	Extra charges	Panel options	without Anti-Plaque		with Anti-Plaque	
				Glass code	Extra charges	Glass code	Extra charges
White	055	0,-	Styrene Pacific S clear	264	0,-		
Matt silver	087		Clear	321	78,-	322	209,-

HÜPPE Combinett 2 Bath-top shower screen

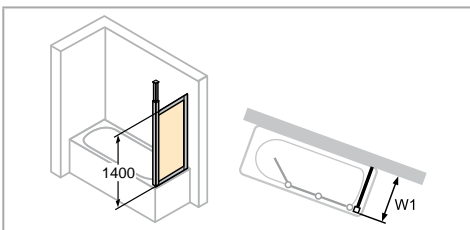

	<p>Dimensions</p> <p>WL: 20 R: 20 Mx: M+10 MG: 20</p>
<p>WEM = Tray installation dim. (000) M = installation dimension Centre glass (001) Please always specify when ordering.</p>	

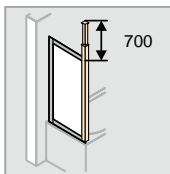
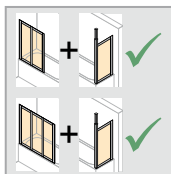
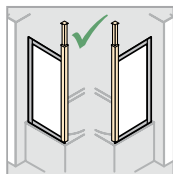
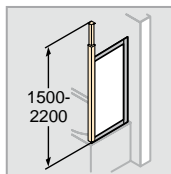
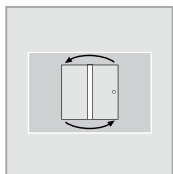
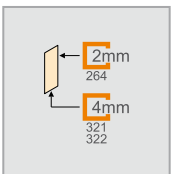

Side panel

Height	Tray size W1	WEM	Product no.	Base price
1400	700	680-700	AC1001	375,-
	750	730-750	AC1002	

Made-to-measure

Height	Model	Glass Total width	Total acrylic width	Product no.	Base price
to 1500	Corner configuration	200-1200	200-1000	AC1080	487,-
	In-line configuration	200-1200	200-1000	AC1081	

Adjustment range = dimensions - 10mm / + 10mm

Slopes and cut-outs

Slopes and cut-outs	Extra charges
	Supplement per slope/cut-out for made-to-measure 170,-

Dim. Range: min. - max.

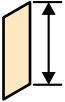
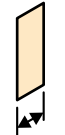
	
to 1500	200-1200

Colours - Panel options

Profile colours	Colour code	Extra charges	Panel options	without Anti-Plaque		with Anti-Plaque	
				Glass code	Extra charges	Glass code	Extra charges
White	055	0,-	Styrene Pacific S clear	264	0,-		
Matt silver	087		Clear	321	63,-	322	209,-

HÜPPE Solva pure frameless Bath-top shower screen

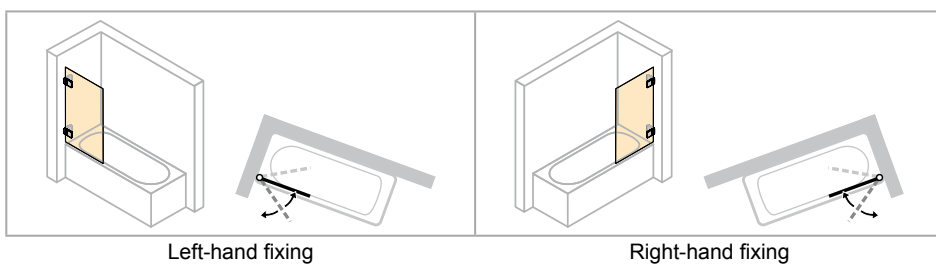

Left-hand fixing

Right-hand fixing

- Measurements must always be taken.
- Towel rail height can be selected individually and must be specified with the order. If nothing is specified, the towel rail is always delivered middle of glass (height and width).

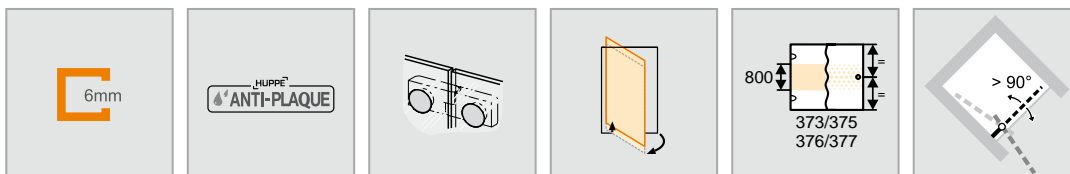



1-panel

Made-to-measure

Height	Width	Left-hand fixing Product no.	Right-hand fixing Product no.	Base price
1500-2000	500-1000	SR3480	SR3580	914,-
2001-2200	500-900	SR3481	SR3581	1.461,-

Dim. Range: min. - max.

	
1500-2000	500-1000
2001-2200	500-900

Special options

Optional variants		Extra charges
Towel rail (silver high-gloss)	T99	210,-

Colours - Panel options

Profile colours	Colour code	Extra charges	Panel options		without Anti-Plaque		with Anti-Plaque	
					Glass code	Extra charges	Glass code	Extra charges
Silver high-gloss	092	0,-	Clear		321	0,-	322	209,-
			Grey		301		368	
			Bronze		341		378	
			Sand Plus		315	186,-	316	395,-
			Privatima		373		375	
			Bubbles		376		377	
			Mirror glass		380	439,-	381	648,-

HÜPPE Solva pure frameless Bath-top shower screen

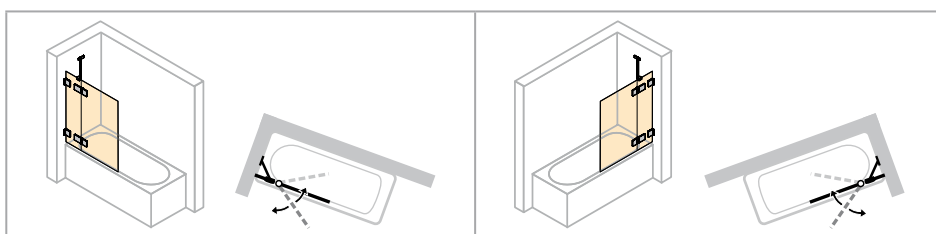
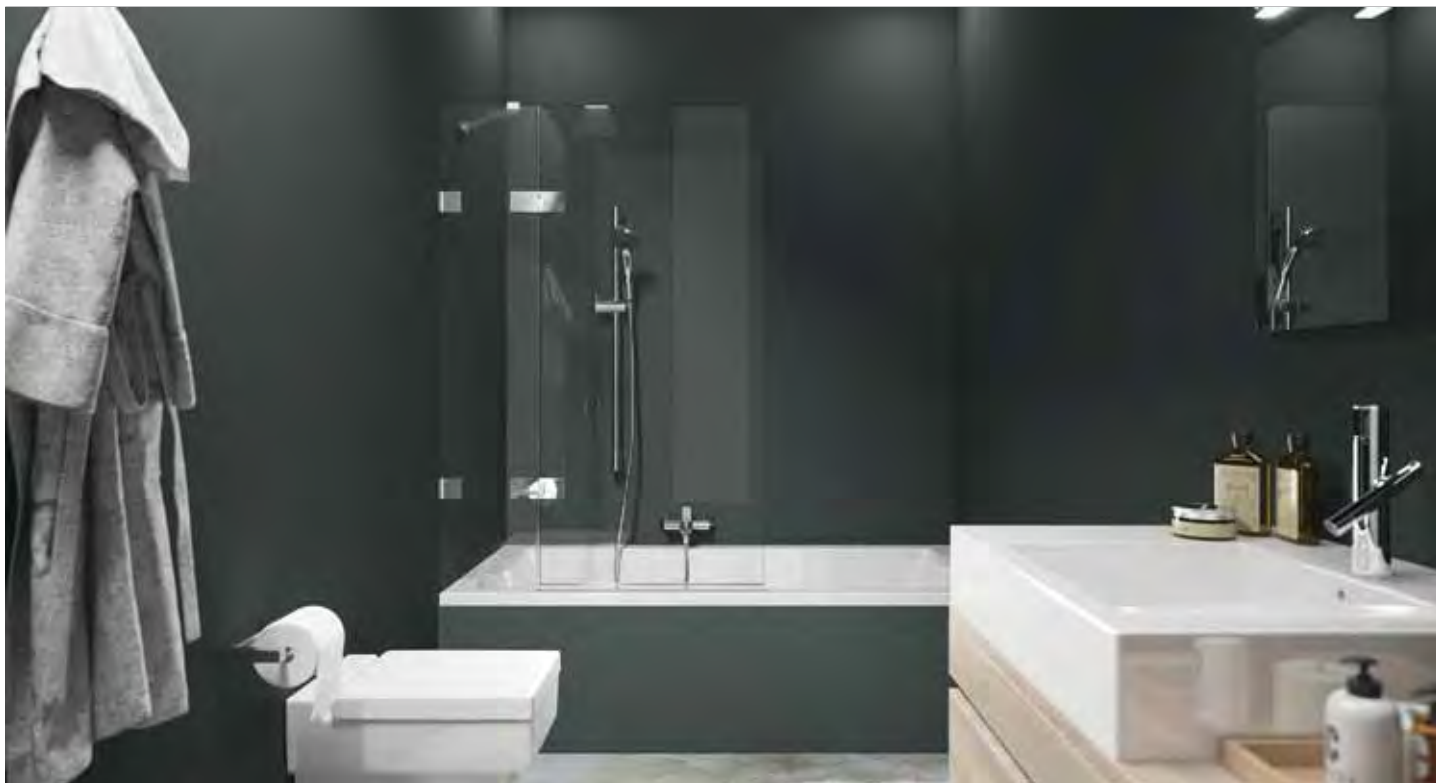

Left-hand fixing

Right-hand fixing

- Measurements must always be taken.
- Mirror glass (380/381): Please state in your order which segment should be produced with mirror glass. If this is not stated, the entire unit will be produced with mirror glass.
- For technical information, see Profile Colours and Panel Options section.

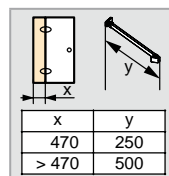
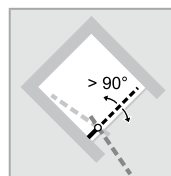
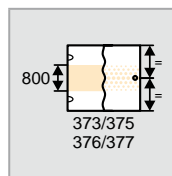
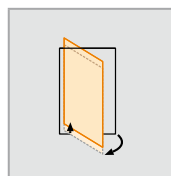
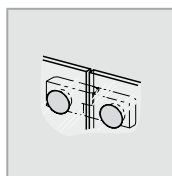
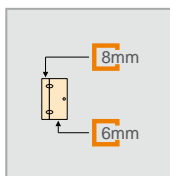





1-panel with fixed segment

Made-to-measure

Height	Width Door front	Left-hand fixing Product no.	Right-hand fixing Product no.	Base price
1500-2000	600-1200	SR2180	SR2280	1.372,-
	1201-1500	SR2182	SR2282	2.028,-
2001-2200	600-1200	SR2181	SR2281	1.919,-
	1201-1500	SR2183	SR2283	2.576,-

Dim. Range: min. - max.

			
1500-2200	600-1500	220-600	max. 900

Colours - Panel options

Profile colours	Colour code	Extra charges	Panel options				
			without Anti-Plaque Glass code	with Anti-Plaque Glass code			
Silver high-gloss	092	0,-	Clear	321	0,-	322	209,-
			Grey	301		368	
			Bronze	341	186,-	378	395,-
			Sand Plus	315		316	
			Privatima	373		375	
			Bubbles	376		377	
			Mirror glass	380	439,-	381	648,-

HÜPPE Solva pure frameless Bath-top shower screen

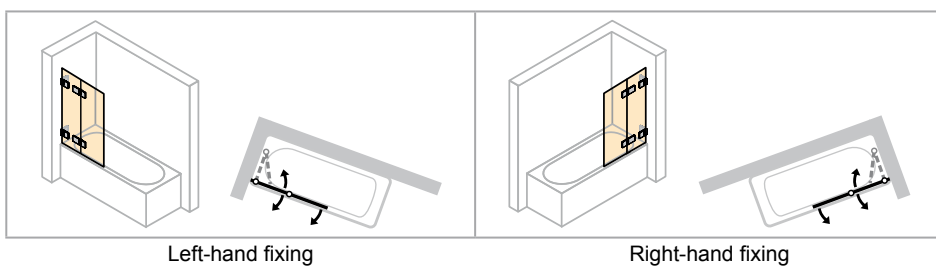
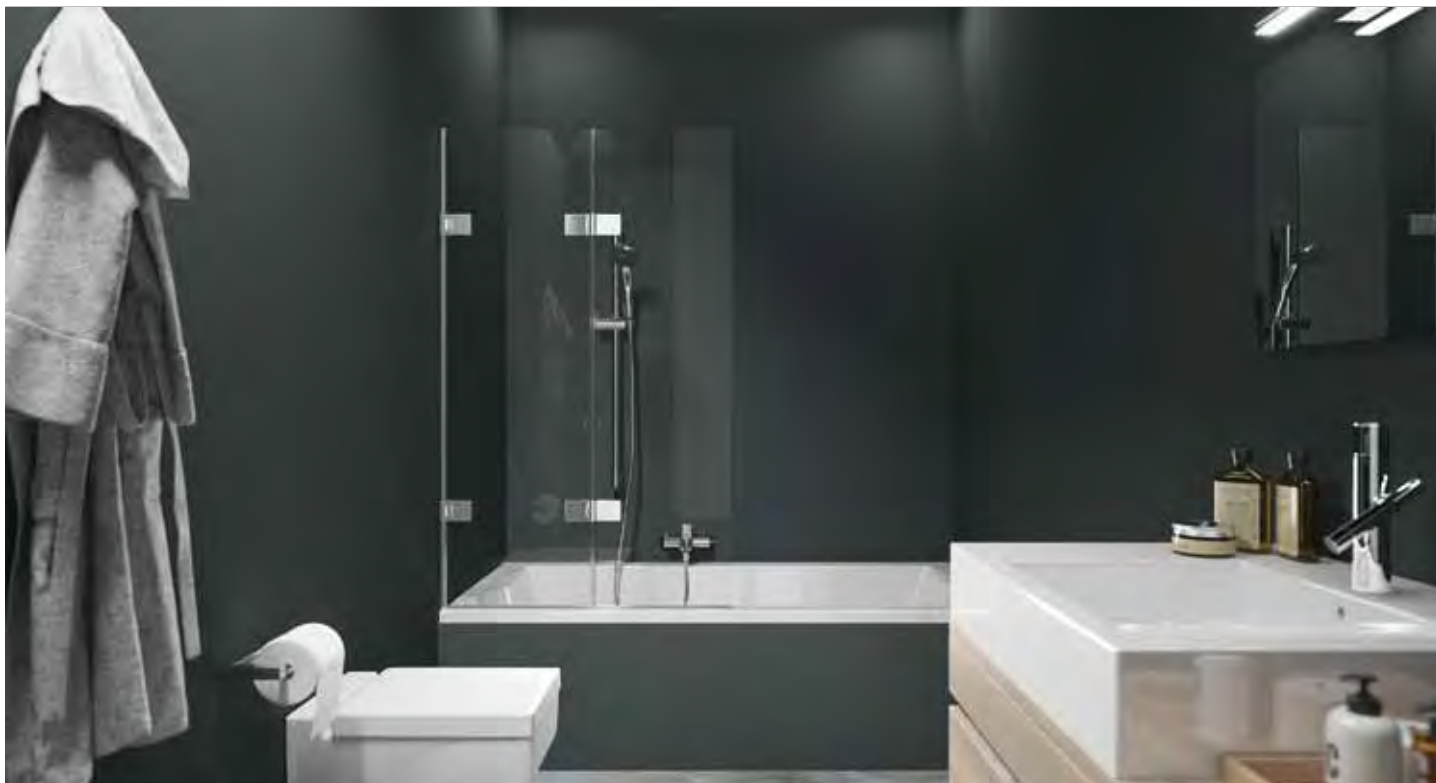

Left-hand fixing

Right-hand fixing

- Measurements must always be taken.
- Mirror glass (380/381): Please state in your order which segment should be produced with mirror glass. If this is not stated, the entire unit will be produced with mirror glass.
- For technical information, see Profile Colours and Panel Options section.

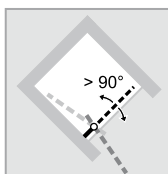
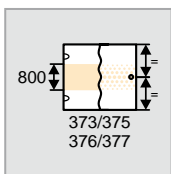
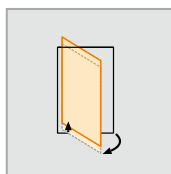
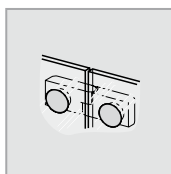
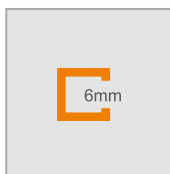



Folding swing door

Made-to-measure

Height	Width Door front	Left-hand fixing Product no.	Right-hand fixing Product no.	Base price
1500-2000	500-1250	SR4880	SR4980	1.511,-

Dim. Range: min. - max.

	
1500-2000	500-1250

Colours - Panel options

Profile colours	Colour code	Extra charges	Panel options	without Anti-Plaque		with Anti-Plaque	
				Glass code	Extra charges	Glass code	Extra charges
Silver high-gloss	092	0,-	Clear	321	0,-	322	209,-
			Grey	301		368	
			Bronze	341		378	
			Sand Plus	315	186,-	316	395,-
			Privatima	373		375	
			Bubbles	376		377	
			Mirror glass	380	439,-	381	648,-

HÜPPE Solva pure partially framed Bath-top shower screen

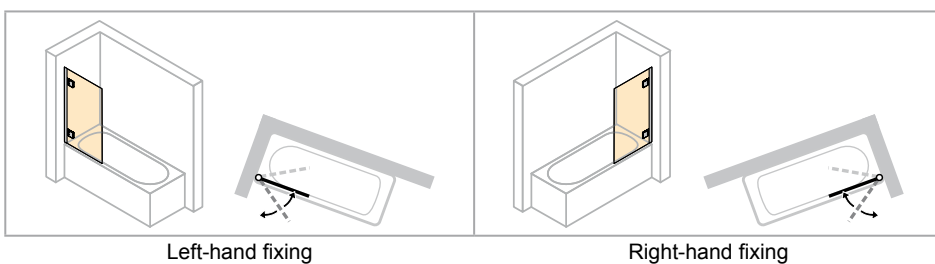
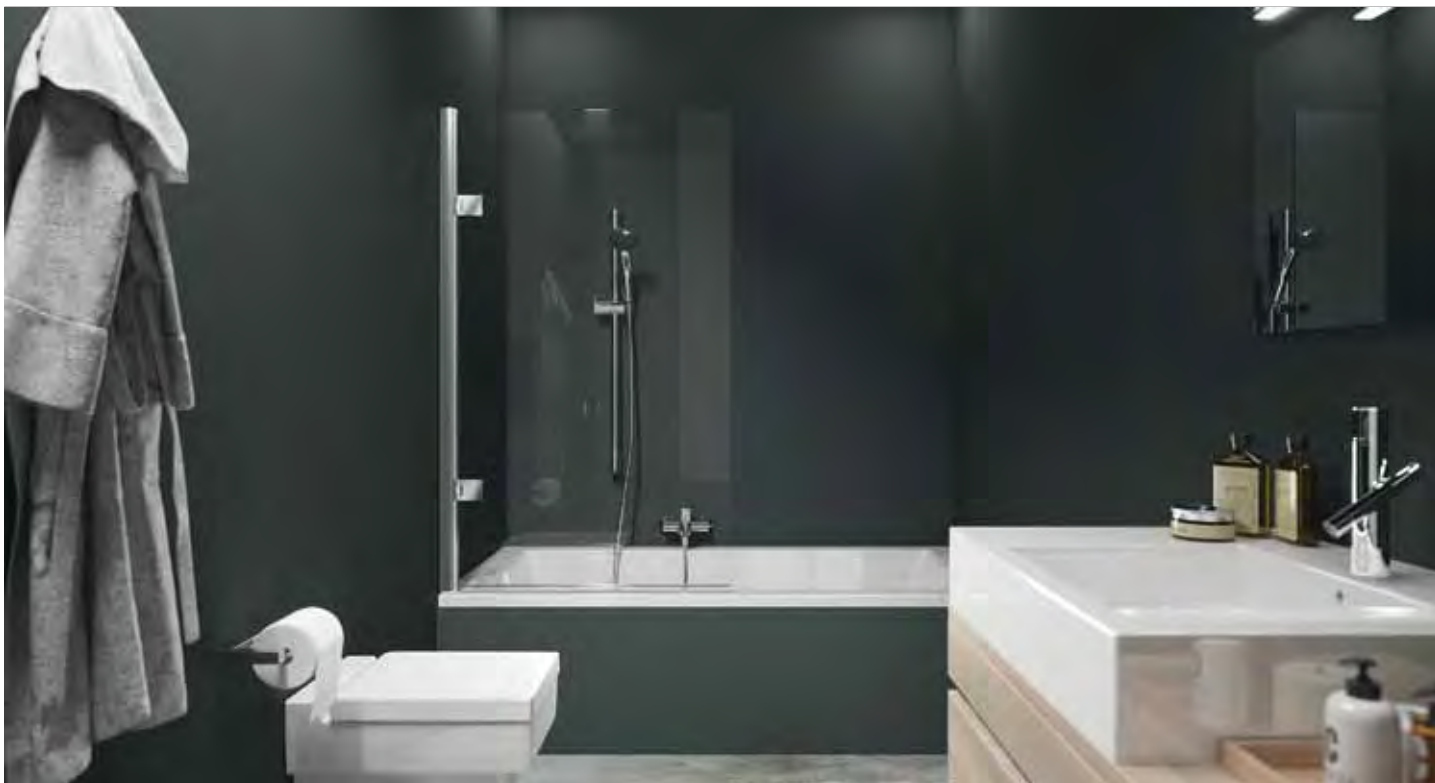

- Towel rail height can be selected individually and must be specified with the order. If nothing is specified, the towel rail is always delivered middle of glass (height and width).

	<p>Dimensions</p> <p>WL: 31 R: 12 Mx: M+18 MG: 30</p>
<p>WEM = Tray installation dim. (000) M = installation dimension Centre glass (001) Please always specify when ordering.</p>	

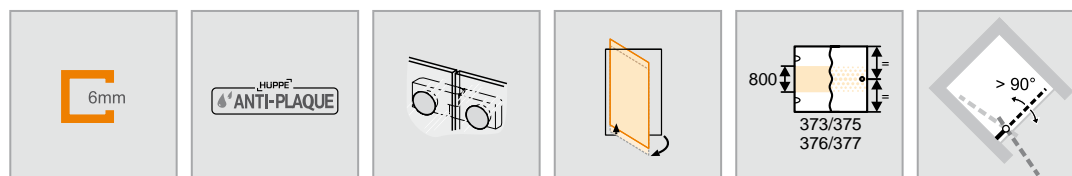

HÜPPE Solva pure partially framed Bath-top shower screen

1-panel



Height	Model	Width	Left-hand fixing Product no.	Right-hand fixing Product no.	Base price
1500	750	740-755	ST3401	ST3501	721,-

Made-to-measure

Height	Width Door front	Left-hand fixing Product no.	Right-hand fixing Product no.	Base price
1500-2000	500-1000	ST3480	ST3580	914,-
2001-2200	500-900	ST3481	ST3581	1.461,-

Adjustment range = dimensions - 8mm / + 7mm

Dim. Range: min. - max.

	
1500-2000	500-1000
2001-2200	500-900

Special options

Optional variants		Extra charges
Towel rail (silver high-gloss)	T99	210,-

Colours - Panel options

Profile colours	Colour code	Extra charges	Panel options	without Anti-Plaque		with Anti-Plaque	
				Glass code	Extra charges	Glass code	Extra charges
Silver high-gloss	092	0,-	Clear	321	0,-	322	209,-
			Grey	301		368	
			Bronze	341		378	
			Sand Plus	315	186,-	316	395,-
			Privatima	373		375	
			Bubbles	376		377	
			Mirror glass	380	439,-	381	648,-

HÜPPE Solva pure partially framed Bath-top shower screen

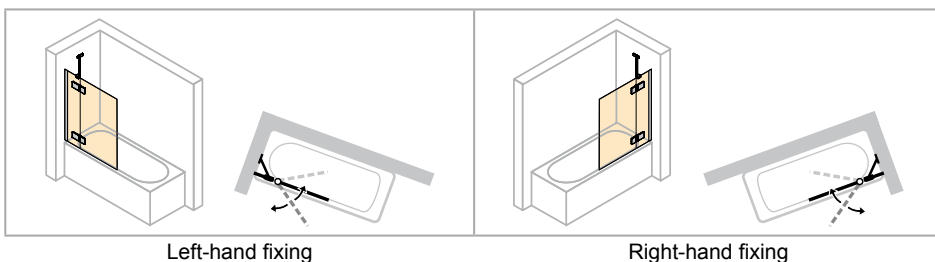

Left-hand fixing

Right-hand fixing

- Mirror glass (380/381): Please state in your order which segment should be produced with mirror glass. If this is not stated, the entire unit will be produced with mirror glass.
- For technical information, see Profile Colours and Panel Options section.

Dimensions

WL: 31
R: 12
Mx: M+18
MG: 30

WEM = Tray installation dim. (000)
M = installation dimension Centre glass (001)
Please always specify when ordering.

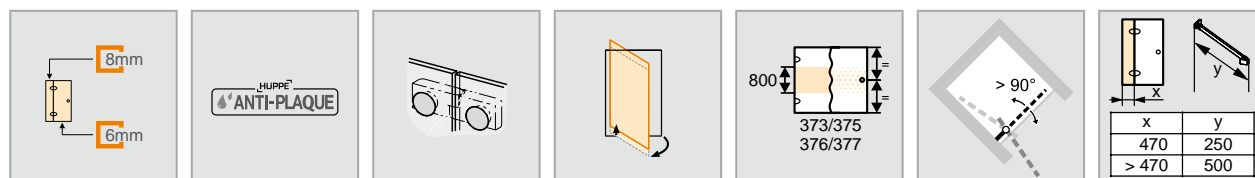

HÜPPE Solva pure partially framed Bath-top shower screen

1-panel with fixed segment

Height	Model	Door width	Width of fixed segment	Left-hand fixing Product no.	Right-hand fixing Product no.	Base price
1500	950	940-955	270-285	ST2101	ST2201	1.080,-

Made-to-measure





Height	Width Door front	Left-hand fixing Product no.	Right-hand fixing Product no.	Base price
1500-2000	600-1200	ST2180	ST2280	1.372,-
	1201-1500	ST2182	ST2282	2.028,-
2001-2200	600-1200	ST2181	ST2281	1.919,-
	1201-1500	ST2183	ST2283	2.576,-

Adjustment range = dimensions - 8mm / + 7mm

Slopes and cut-outs

Slopes	Extra charges
	Supplement per slope/cut-out for made-to-measure 170,-

Dim. Range: min. - max.

			
1500-2200	200-600	max. 900	600-1500

Colours - Panel options

Profile colours	Colour code	Extra charges	Panel options		without Anti-Plaque		with Anti-Plaque	
			Glass code	Extra charges	Glass code	Extra charges		
Silver high-gloss	092	0,-	Clear	321	0,-	322	209,-	
			Grey	301		368		
			Bronze	341		378		
			Sand Plus	315	186,-	316	395,-	
			Privatima	373		375		
			Bubbles	376		377		
			Mirror glass	380	439,-	381	648,-	

HÜPPE Solva pure partially framed Bath-top shower screen

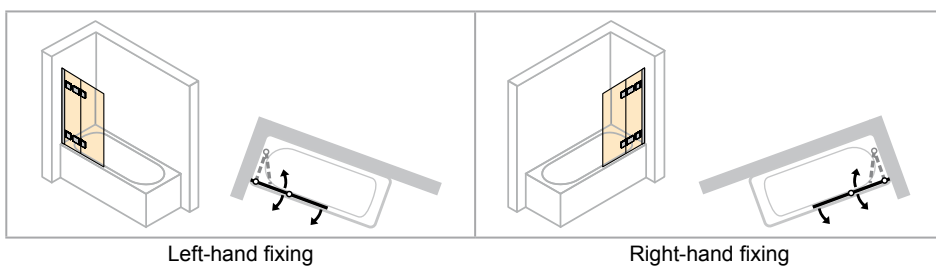

- Mirror glass (380/381): Please state in your order which segment should be produced with mirror glass. If this is not stated, the entire unit will be produced with mirror glass.
- For technical information, see Profile Colours and Panel Options section.

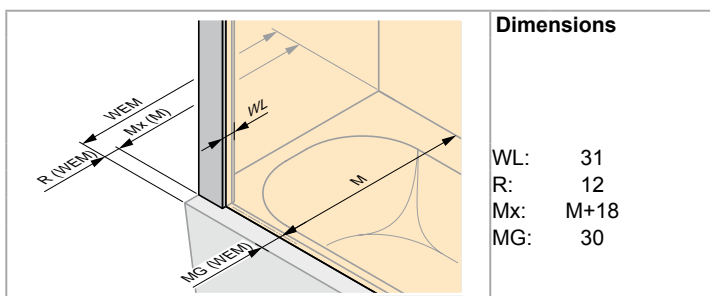

WEM = Tray installation dim. (000)
 M = installation dimension Centre glass (001)
 Please always specify when ordering.

6mm

HÜPPE
ANTI-PLAQUE

800

373/375
376/377

> 90°

HÜPPE Solva pure partially framed Bath-top shower screen

Folding swing door

Height	Model	Width	Folded width F	Profile thickness P	Left-hand fixing Product no.	Right-hand fixing Product no.	Base price
1500	1000	990-1005	497	95-110	ST4801	ST4901	1.189,-
	1200	1190-1205	597	95-110	ST4802	ST4902	1.247,-



Adjustment range = dimensions - 8mm / + 7mm

Made-to-measure

Height	Width Door front	Left-hand fixing Product no.	Right-hand fixing Product no.	Base price
1500-2000	500-1250	ST4880	ST4980	1.511,-

Adjustment range = dimensions - 8mm / + 7mm

Dim. Range: min. - max.

	
1500-2000	500-1250

Colours - Panel options

Profile colours	Colour code	Extra charges	Panel options	without Anti-Plaque		with Anti-Plaque	
				Glass code	Extra charges	Glass code	Extra charges
Silver high-gloss	092	0,-	Clear	321	0,-	322	209,-
			Grey	301		368	
			Bronze	341		378	
			Sand Plus	315	186,-	316	395,-
			Privatima	373		375	
			Bubbles	376		377	
			Mirror glass	380	439,-	381	648,-

HÜPPE Studio Paris elegance frameless Bath-top shower screen

HÜPPE Studio Berlin pure frameless Bath-top shower screen

HÜPPE Studio Paris elegance

HÜPPE Studio Berlin pure

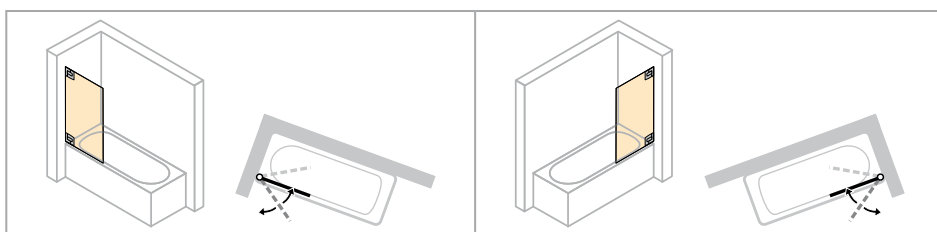
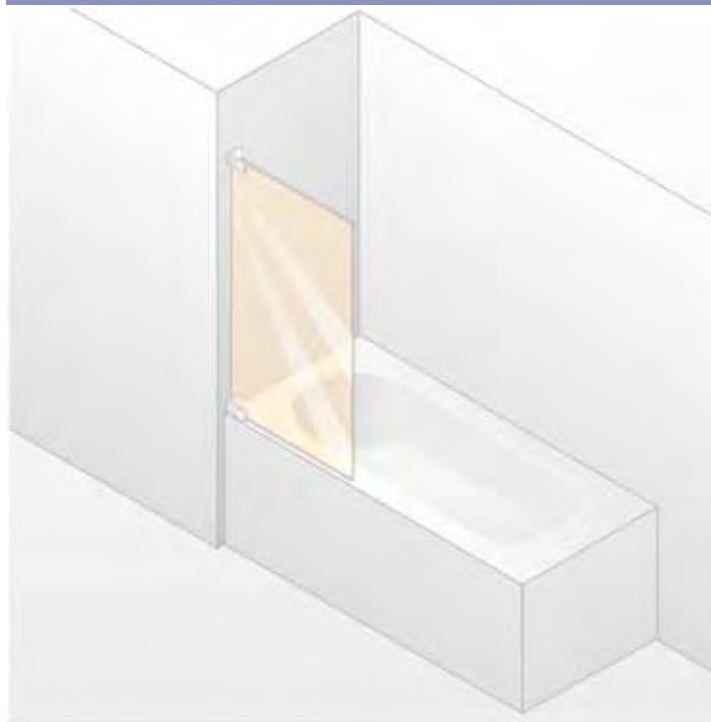
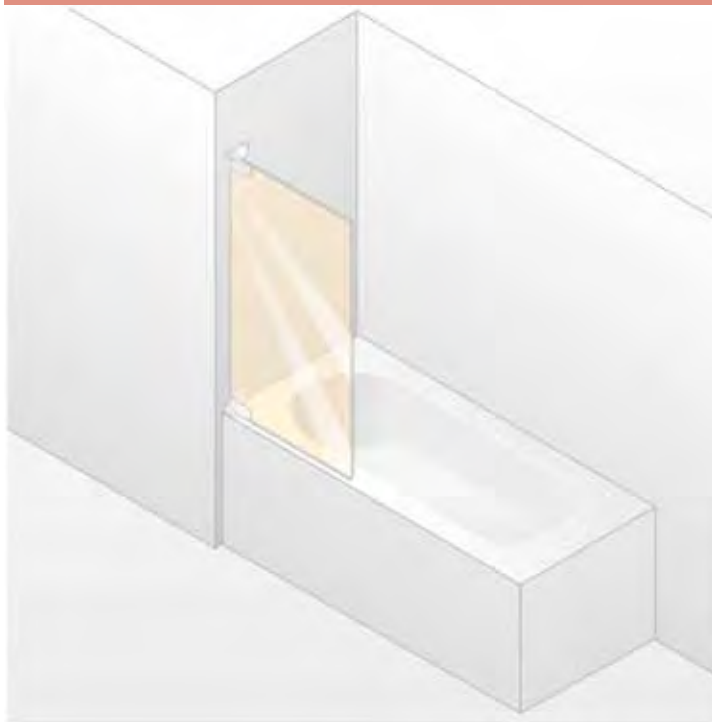

Left-hand fixing

Right-hand fixing

- Measurements must always be taken.
- Price including slopes and cut-outs.
- Chrome look sealing strip.
- Individual galvanised surfaces: stainless steel look, old brass, high grade brass.
- Towel rail height can be selected individually and must be specified with the order. If nothing is specified, the towel rail is always delivered middle of glass (height and width).

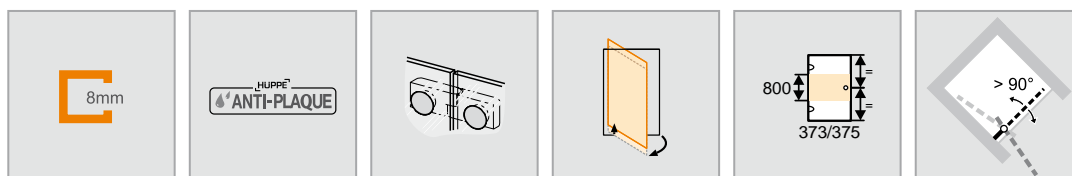

HÜPPE Studio Paris elegance frameless Bath-top shower screen

HÜPPE Studio Berlin pure frameless Bath-top shower screen

1-panel



Made-to-measure - Left-hand fixing

Height	Width	PARIS	BERLIN	Base price
to 1500	500-1000	PR0409	BR0409	874,-
1501-2200	500-900	PR040E	BR040E	1.221,-

Made-to-measure - Right-hand fixing

Height	Width	PARIS	BERLIN	Base price
to 1500	500-1000	PR0419	BR0419	874,-
1501-2200	500-900	PR041E	BR041E	1.221,-

Dim. Range: min. - max.

	
to 1500	500-1000
1501-2200	500-900

Special options

Optional variants		Extra charges
Towel rail (high-gloss silver as standard, towel rail in black for Black Edition systems)	T99	210,-

Colours - Panel options

Basic/inlay colours	Colour code	Extra charges	Panel options	without Anti-Plaque		with Anti-Plaque	
				Glass code	Extra charges	Glass code	Extra charges
Black Edition	123	171,-	Clear	321	0,-	322	209,-
Individual RAL colours	998	303,-	Karo	311		312	
Individual galvanised surfaces	999	726,-	Sand Plus	315	186,-	316	395,-
Basic colours			Privatima	373		375	
Fittings			Mirror glass	380	439,-	381	648,-
High-grade matt chrome	E	0,-	Further panel options HÜPPE Studio Paris elegance/ HÜPPE Studio Berlin pure - see chapter intro.				
Chrome	C	177,-					
Brilliant gold	G	250,-					
Inlay colours	Colour code	Extra charges					
Brilliant gold	02	0,-					
High-grade matt chrome	05						
Black	23						
White	55						
Chrome	91						

HÜPPE Studio Paris elegance frameless Bath-top shower screen
HÜPPE Studio Berlin pure frameless Bath-top shower screen

HÜPPE Studio Paris elegance



HÜPPE Studio Berlin pure

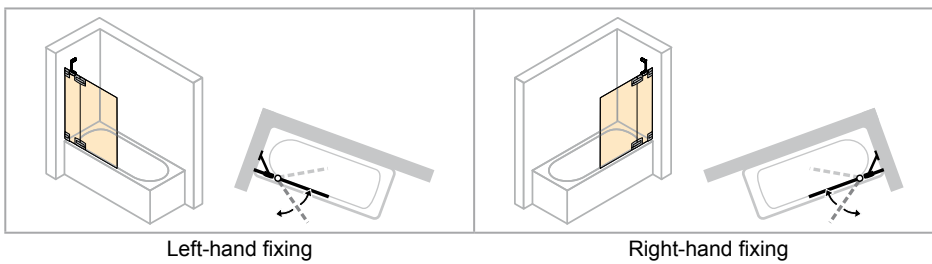
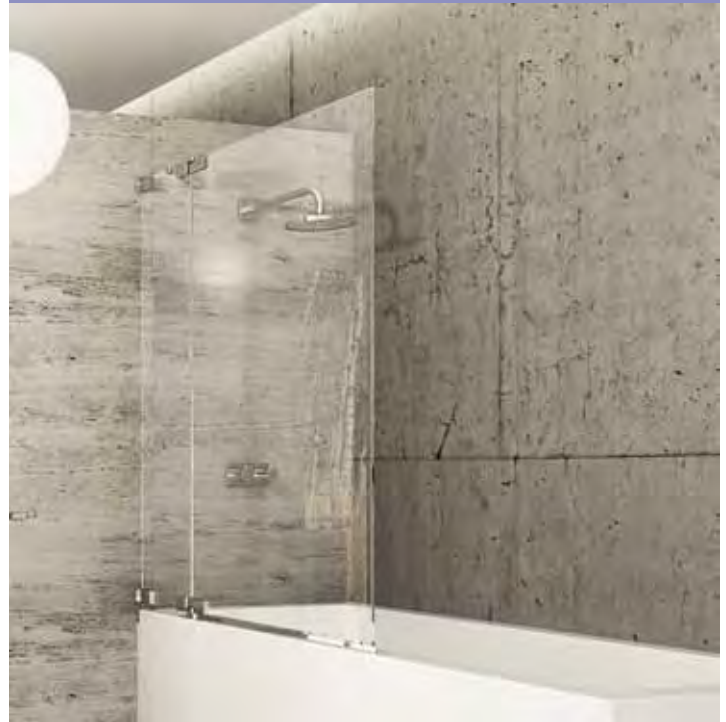

- Measurements must always be taken.
- Price including slopes and cut-outs.
- Chrome look sealing strip.
- Individual galvanised surfaces: stainless steel look, old brass, high grade brass.
- Mirror glass (380/381): Please state in your order which segment should be produced with mirror glass. If this is not stated, the entire unit will be produced with mirror glass.
- For technical information, see Profile Colours and Panel Options section.

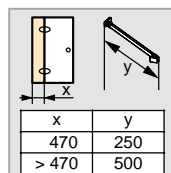
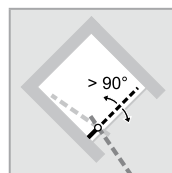
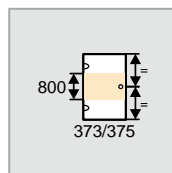
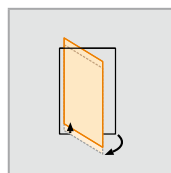
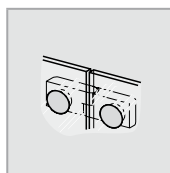
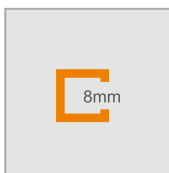

HÜPPE Studio Paris elegance frameless Bath-top shower screen

HÜPPE Studio Berlin pure frameless Bath-top shower screen

1-panel with fixed segment

Made-to-measure - Left-hand fixing

Height	Width of door front	PARIS	BERLIN	Base price
to 1500	600-1200	PR0429	BR0429	1.452,-
	1201-1500	PR042F	BR042F	1.846,-
1501-2200	600-1200	PR042E	BR042E	1.798,-
	1201-1500	PR042G	BR042G	2.191,-

Made-to-measure - Right-hand fixing

Height	Width of door front	PARIS	BERLIN	Base price
to 1500	600-1200	PR0439	BR0439	1.452,-
	1201-1500	PR043F	BR043F	1.846,-
1501-2200	600-1200	PR043E	BR043E	1.798,-
	1201-1500	PR043G	BR043G	2.191,-

Dim. Range: min. - max.

to 2200	600-1500	210-600	max. 900

Colours - Panel options

Basic/inlay colours	Colour code	Extra charges
Black Edition	123	171,-
Individual RAL colours	998	303,-
Individual galvanised surfaces	999	726,-
Basic colours	Colour code	Extra charges
Fittings		
High-grade matt chrome	E	0,-
Chrome	C	177,-
Brilliant gold	G	250,-
Inlay colours	Colour code	Extra charges
Brilliant gold	02	0,-
High-grade matt chrome	05	
Black	23	
White	55	
Chrome	91	

Panel options	without Anti-Plaque		with Anti-Plaque	
	Glass code	Extra charges	Glass code	Extra charges
Clear	321	0,-	322	209,-
Karo	311		312	
Sand Plus	315	186,-	316	395,-
Privatima	373		375	
Mirror glass	380	439,-	381	648,-

**Further panel options HÜPPE Studio Paris elegance/
HÜPPE Studio Berlin pure - see chapter intro.**

HÜPPE Studio Paris elegance partially framed Bath-top shower screen
HÜPPE Studio Berlin pure partially framed Bath-top shower screen

HÜPPE Studio Paris elegance

HÜPPE Studio Berlin pure

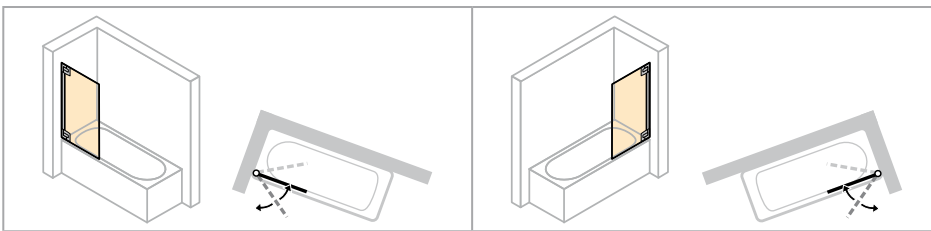
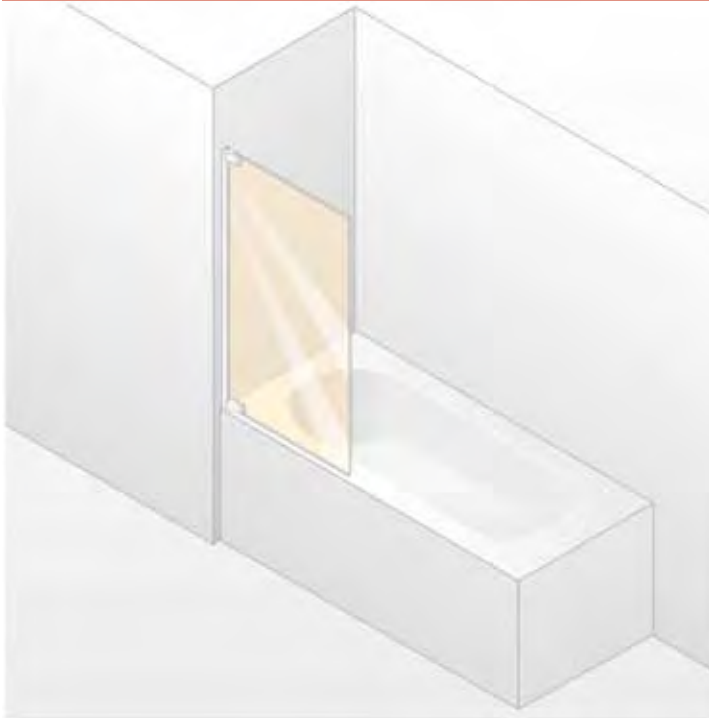

Left-hand fixing

Right-hand fixing

- Price including slopes and cut-outs.
- Chrome look sealing strip.
- Towel rail height can be selected individually and must be specified with the order. If nothing is specified, the towel rail is always delivered middle of glass (height and width).

	<p>Dimensions</p> <p>WL: 34 R: 13 Mx: M+17 MG: 30</p>
<p>WEM = Tray installation dim. (000) M = installation dimension Centre glass (001) Please always specify when ordering.</p>	

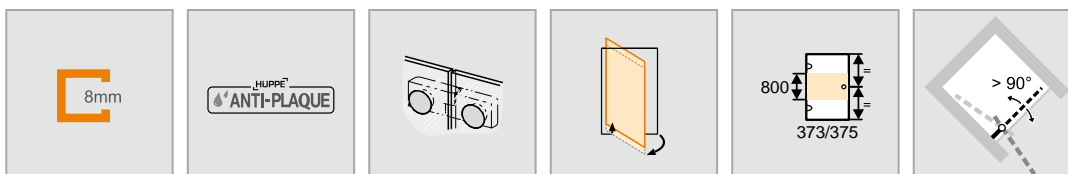

HÜPPE Studio Paris elegance partially framed Bath-top shower screen

HÜPPE Studio Berlin pure partially framed Bath-top shower screen

1-panel

Made-to-measure - Left-hand fixing

Height	Width	PARIS	BERLIN	Base price
to 1500	500-1000	PT0409	BT0409	874,-
1501-2200	500-900	PT040E	BT040E	1.221,-



Adjustment range = dimensions - 8mm / + 7mm

Made-to-measure - Right-hand fixing

Height	Width	PARIS	BERLIN	Base price
to 1500	500-1000	PT0419	BT0419	874,-
1501-2200	500-900	PT041E	BT041E	1.221,-

Adjustment range = dimensions - 8mm / + 7mm

Dim. Range: min. - max.

	
to 1500	500-1000
1501-2200	500-900

Special options

Optional variants		Extra charges
Towel rail (high-gloss silver as standard, towel rail in black for Black Edition systems)	T99	210,-

Colours - Panel options

Basic/inlay colours	Colour code	Extra charges
Black Edition	123	171,-
Individual RAL colours	998	303,-

Basic colours	Profile colour	Colour code	Extra charges
Fittings			
High-grade matt chrome	High-grade matt chrome	E	0,-
Chrome	High-gloss silver	C	177,-
Brilliant gold	pearl gold	G	250,-

Inlay colours	Colour code	Extra charges
Brilliant gold	02	0,-
High-grade matt chrome	05	
Black	23	
White	55	
Chrome	91	

Panel options	without Anti-Plaque		with Anti-Plaque	
	Glass code	Extra charges	Glass code	Extra charges
Clear	321	0,-	322	209,-
Karo	311	186,-	312	395,-
Sand Plus	315		316	
Privatima	373		375	
Mirror glass	380	439,-	381	648,-

**Further panel options HÜPPE Studio Paris elegance/
HÜPPE Studio Berlin pure - see chapter intro.**

HÜPPE Studio Paris elegance partially framed Bath-top shower screen
HÜPPE Studio Berlin pure partially framed Bath-top shower screen

HÜPPE Studio Paris elegance



HÜPPE Studio Berlin pure

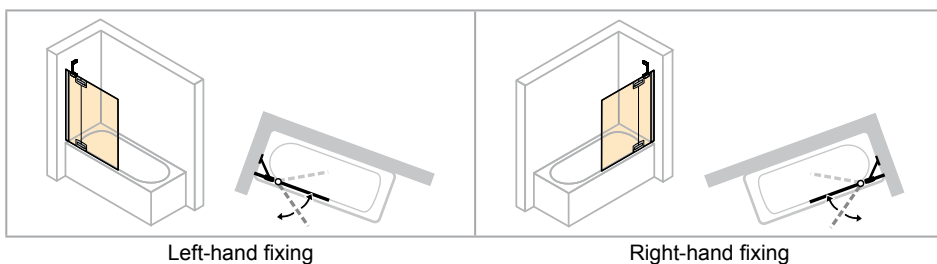

Left-hand fixing

Right-hand fixing

- Price including slopes and cut-outs.
- Chrome look sealing strip.
- Mirror glass (380/381): Please state in your order which segment should be produced with mirror glass. If this is not stated, the entire unit will be produced with mirror glass.
- For technical information, see Profile Colours and Panel Options section.

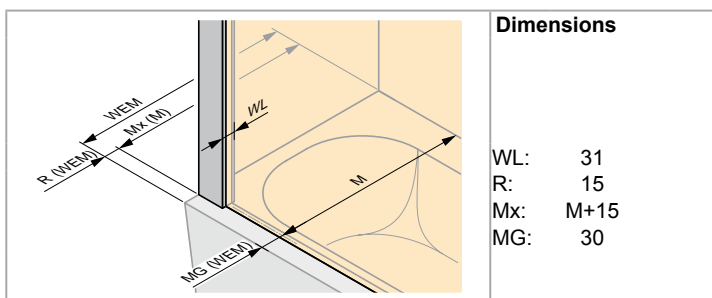

Dimensions

WL: 31
 R: 15
 Mx: M+15
 MG: 30

WEM = Tray installation dim. (000)
 M = installation dimension Centre glass (001)
 Please always specify when ordering.

8mm

HÜPPE
ANTI-PLAQUE

800
373/375

> 90°

x	y
470	250
> 470	500

HÜPPE Studio Paris elegance partially framed Bath-top shower screen

HÜPPE Studio Berlin pure partially framed Bath-top shower screen

1-panel with fixed segment

Made-to-measure - Left-hand fixing

Height	Width of door front	PARIS	BERLIN	Base price
to 1500	600-1200	PT0429	BT0429	1.452,-
	1201-1500	PT042F	BT042F	1.846,-
1501-2200	600-1200	PT042E	BT042E	1.798,-
	1201-1500	PT042G	BT042G	2.191,-

Adjustment range = dimensions - 8mm / + 7mm

Made-to-measure - Right-hand fixing

Height	Width of door front	PARIS	BERLIN	Base price
to 1500	600-1200	PT0439	BT0439	1.452,-
	1201-1500	PT043F	BT043F	1.846,-
1501-2200	600-1200	PT043E	BT043E	1.798,-
	1201-1500	PT043G	BT043G	2.191,-

Adjustment range = dimensions - 8mm / + 7mm

Dim. Range: min. - max.

to 2200	600-1500	210-600	max. 900

Colours - Panel options

Basic/inlay colours		Colour code	Extra charges
Black Edition		123	171,-
Individual RAL colours		998	303,-
Basic colours	Profile colour	Colour code	Extra charges
Fittings			
High-grade matt chrome	High-grade matt chrome	E	0,-
Chrome	High-gloss silver	C	177,-
Brilliant gold	pearl gold	G	250,-
Inlay colours		Colour code	Extra charges
Brilliant gold		02	0,-
High-grade matt chrome		05	
Black		23	
White		55	
Chrome		91	

Panel options	without Anti-Plaque		with Anti-Plaque	
	Glass code	Extra charges	Glass code	Extra charges
Clear	321	0,-	322	209,-
Karo	311	186,-	312	395,-
Sand Plus	315		316	
Privatima	373		375	
Mirror glass	380	439,-	381	648,-

**Further panel options HÜPPE Studio Paris elegance/
HÜPPE Studio Berlin pure - see chapter intro.**

HÜPPE Accessories / Accessory kit Spare Parts



Accessories Z
etc.

Accessories

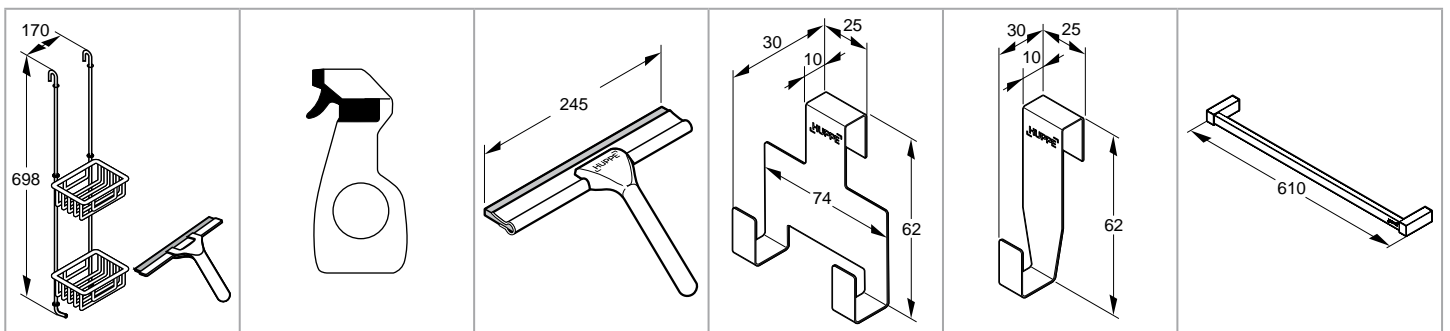

HÜPPE Butler 2000

HÜPPE Flip, Top and Top Plus - Cleaning agents
Contents: 500ml

Wiper

Hook for wiper

Hook for bath towel

Towel rail

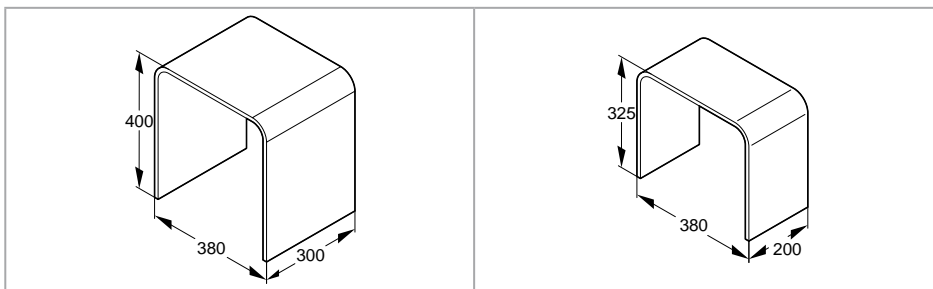

HÜPPE ShowerSeat
Size L

HÜPPE ShowerSeat
Size S

Hook for wiper/Hook for bath towel:

- Minimum order quantity 10 items

HÜPPE ShowerSeat:

- Designed especially for use in shower areas (on shower trays).
- High quality surface finish with a pleasant feel.
- Not sensitive to shocks or impacts.
- Water-resistant.

HÜPPE ShowerSeat

	Model	Dimensions (L x W x H)	Colour	Approx. weight in kg	Material thickness	Ref.	Price
	Size L	300 x 380 x 400	matt white	7,60	12	493000	210,-
	Size S	200 x 380 x 325	matt white	4,43	12	493010	153,-

HÜPPE Butler 2000 - Butler Tidy System for shower enclosures

	Colour	Ref.	Price
	Chrome	492001091	251,-
Standard equipment			
Wiper			

HÜPPE Flip, Top and Top Plus - Cleaning agents

	Model	500ml	Packaging unit	Ref.	Price
	TOP acrylic tray cleaner	Cleaners for shower trays	1	701000000	28,-
	TOP acrylic tray cleaner	Cleaners for shower trays	6	700467000	148,-
	FLIP cleaner	Special cleaner for styrene panels	1	700405000	28,-
	FLIP cleaner	Special cleaner for styrene panels	6	700465000	148,-
	TOP Plus cleaning agent	Special cleaning agent for Anti-Plaque and chrome finishes	1	700415000	28,-
	TOP Plus cleaning agent	Special cleaning agent for Anti-Plaque and chrome finishes	6	700466000	148,-

Wiper / Hook for wiper / Hook for bath towel

	Model	Colour	Packaging unit	Ref.	Price
	Wiper	Chrome	1	608510000	27,-
	Hook for wiper	Chrome	1	600311000	8,-
	Hook for bath towel	Chrome	1	600310000	5,-

Towel rail

	Model	Colour	Packaging unit	Ref.	Price
	Towel rail (glued, can be shortened)	069 silver high-gloss, 087 matt silver, 023 black, 061 grey/brown, 055 white	1	T01010	210,-

NOTE: The glued towel rail is not suitable for the following glasses:

- 264 Styrene Pacific S clear
- 311 Karo / 312 Karo Anti-Plaque
- 315 Sand Plus / 316 Sand Plus Anti-Plaque
- 373 Privatima / 375 Privatima Anti-Plaque
- 376 Bubbles / 377 Bubbles Anti-Plaque
- 380 mirror glass / 381 mirror glass Anti-Plaque

Accessory kit

Side panel

Accessories for U-shaped enclosure

			HÜPPE Alpha 2	HÜPPE Classics 2	HÜPPE Design elegance swing doors	HÜPPE Design pure swing doors	HÜPPE 501 Design pure	HÜPPE Design elegance sliding doors	HÜPPE Design pure sliding doors	Product no.	Price
	Set of stabilizers, U-shaped enclosure Connecting side panel with wall (1 set, 2 pcs. each)		X	X						C26001	111,-
	Stabilizer set							X	X	8P5201	
	Profile for U-enclosure for swing door with fixed segment				X					8E4080	
	Profile for U-enclosure for two-way door				X					8E4180	
	Profile for U-enclosure for swing door with fixed segment					X				8P4080	
	Profile for U-enclosure for two-way door					X				8P4180	
	Profile for U-enclosure for two-way door						X			510695	
	Profile for U-enclosure for swing door with fixed segment						X			510696	

Length	Stabilizer/cross bar										Product no.	Price		
	pure	elegance	pure				elegance							
			HÜPPE Classics 2	HÜPPE Design pure	HÜPPE 501 Design pure	HÜPPE Enjoy pure	HÜPPE Refresh pure	HÜPPE Solva pure	HÜPPE Aura elegance	HÜPPE Design elegance	HÜPPE Design victorian	HÜPPE Enjoy elegance		
150mm	Stabilizer (solid wall/glass) for glass 6-8mm		X	X	X	X	X	X					SP0100	69,-
	Stabilizer (solid wall/glass) for glass 6-8mm								X	X	X	X	SE0100	
250mm	Stabilizer (solid wall/glass) for glass 6-8mm		X	X	X	X	X	X					SP0101	72,-
	Stabilizer (glass/glass) for glass 6-8mm		X	X	X	X	X	X					SP0201	
	Stabilizer (solid wall/glass) for glass 6-8mm								X	X	X	X	SE0101	
	Stabilizer (glass/glass) for glass 6-8mm								X	X	X	X	SE0201	
	Stabilizer (solid wall/glass) for glass 6-8mm (for sloped ceilings)		X	X	X	X	X	X	X	X	X	X	S00101	
500mm	Stabilizer (solid wall/glass) for glass 6-8mm		X	X	X	X	X	X					SP0102	74,-
	Stabilizer (glass/glass) for glass 6-8mm		X	X	X	X	X	X					SP0202	
	Stabilizer (solid wall/glass) for glass 6-8mm								X	X	X	X	SE0102	
	Stabilizer (glass/glass) for glass 6-8mm								X	X	X	X	SE0202	
	Stabilizer (solid wall/glass) for glass 6-8mm (for sloped ceilings)		X	X	X	X	X	X	X	X	X	X	S00102	
800mm	Stabilizer (solid wall/glass) for glass 6-8mm		X	X	X	X	X	X					SP0501	89,-
	Stabilizer (solid wall/glass) for glass 6-8mm								X	X	X	X	SE0501	
1200mm	Cross bar (glass/glass) for 6-8mm glass thickness		X	X	X	X	X	X					SP0301	124,-
	Cross bar (solid wall/glass) for 6-8mm glass thickness		X	X	X	X	X	X					SP0302	
	Cross bar (glass/glass) for 6-8mm glass thickness								X	X	X	X	SE0301	
	Cross bar (solid wall/glass) for 6-8mm glass thickness								X	X	X	X	SE0302	
	Cross bar (solid wall/glass) for 6-8mm glass thickness (for sloped ceilings)		X	X	X	X	X	X	X	X	X	X	S00301	

Side panel

Stabilizer/cross bar						
Length			HÜPPE Studio Paris elegance	HÜPPE Studio Berlin pure	Product no.	Price
151-300mm	Stabilizer (solid wall/glass) for glass 6-8mm (for sloped ceilings)		X	X	S00401	109,-
301-550mm	Stabilizer (solid wall/glass) for glass 6-8mm (for sloped ceilings)		X	X	S00402	
to 1200mm	Cross bar (solid wall/glass)		X		P00001	242,-
	Cross bar (solid wall/glass)			X	B00001	
	Cross bar (glass/glass)		X		P00005	
	Cross bar (glass/glass)			X	B00005	
to 2000mm	Cross bar (solid wall/glass)		X		P00002	262,-
	Cross bar (solid wall/glass)			X	B00002	
	Cross bar (glass/glass)		X		P00006	
	Cross bar (glass/glass)			X	B00006	

Length		HÜPPE Xtensa pure	Product no.	Price
to 2000mm	T-solution supplement set (in combination with Xtensa pure standard stabilizer)		XT0501	262,-
80-600mm	Ceiling connection		XT1606	119,-

Additional angle for inside fastening									
			HÜPPE Enjoy elegance	HÜPPE Enjoy pure	HÜPPE Studio Paris elegance	HÜPPE Studio Berlin pure	HÜPPE Solva pure frameless	Product no.	Price
	Additional angle for inside fastening		X					3R0010	30,-
	Additional angle for inside fastening			X				4R0010	
	Additional angle for inside fastening				X			P00010	
	Additional angle for inside fastening				X		B00010		
	Cover plate for wall bracket, Inside installation				X			P00011	
	Cover plate for wall bracket, Inside installation					X		B00011	25,-
	Inner wall angle, adjustable						X	SR7001	57,-
	Outer wall angle, adjustable						X	SR7002	

Accessory kit

Side panel

T-solution -stabilizer, complete						
Length			HÜPPE Studio Paris elegance	HÜPPE Studio Berlin pure	Product no.	Price
1200mm x 150mm	T-solution brace, complete (solid wall/glass/glass)		X		P00003	262,-
	T-solution brace, complete (solid wall/glass/glass)			X	B00003	
to 2000mm x 150mm	T-solution brace, complete (solid wall/glass/glass)		X		P00007	289,-
	T-solution brace, complete (solid wall/glass/glass)			X	B00007	
	T-solution brace, complete (solid wall/solid wall/glass)			X		
150mm	Additional T-solution (in combination with cross bar solid wall/glass)		X		P00004	242,-
	Additional T-solution (in combination with cross bar solid wall/glass)			X	B00004	

T-solution -stabilizer, complete											
Length			HÜPPE Aura elegance	HÜPPE Design elegance swing doors	HÜPPE Design pure swing doors	HÜPPE 501 Design pure	HÜPPE Enjoy elegance	HÜPPE Enjoy pure	HÜPPE Solva pure	Product no.	Price
to 2000mm x 150mm	T-solution brace, complete (solid wall/glass/glass)		X				X			SE0601	269,-
	T-solution brace, complete (solid wall/glass/glass)						X	X		SP0601	
	T-solution brace, complete (solid wall/solid wall/glass)		X				X			SE0602	
	T-solution brace, complete (solid wall/solid wall/glass)						X	X		SP0602	
	T-solution brace, complete (solid wall/glass/glass)			X						SE0603	
	T-solution brace, complete (solid wall/glass/glass)				X	X				SP0603	
150mm	Additional T-solution (in combination with cross bar solid wall/glass)		X				X			SE0604	223,-
	Additional T-solution (in combination with cross bar solid wall/glass)						X	X		SP0604	
	Additional T-solution (in combination with cross bar solid wall/glass), shortened connection			X						SE0605	
	Additional T-solution (in combination with cross bar solid wall/glass), shortened connection				X	X				SP0605	

Tray repair kit / Drip deflector / Sealing strip

Tray repair kit		Colour	Product no.	Price		
Tray repair kit (filler)		White	070058000	62,-		
Length	Cross-section	Spare part	For glass thickness	Product no.	Price	
2000mm		Drip deflector	6mm	070002	62,-	
2100mm		Drip deflector	8mm	070003		
880mm		Drip deflector, curved	6mm	070043		
977mm		Drip deflector, curved	8mm	070044		
2100mm		Drip deflector II	6mm	070004		
		Drip deflector II	8mm	070005		
970mm		Drip deflector, curved	6mm	070055		
		Drip deflector, curved	8mm	070056		
1050mm		Drip deflector, straight	6mm	070057		
		Drip deflector, straight	8mm	070053		
2000mm		Drip deflector	8mm	070006		
		End profile	6mm	070007		
2012mm		Vertical water-seal strip		070009		
		Outlet cover cap, chrome/round		070059		17,-
		Outlet cover cap, white/round		070060		
		Outlet cover cap, gold/round		070061	121,-	
		Outlet cover cap, white/square		070062	17,-	
1000mm		Drip deflector, straight	6mm/8mm	070089	30,-	
2000mm		Drip deflector strip		070091	89,-	



ATTENTION: Spare parts are unworked, treatment on site according to original part / sample

Glass thickness of product - please see technical information of the model

Prices plus 6,- Euro freight charges per shipment, where delivered separately.

Length	HÜPPE drip deflector cardboard display	Quantity	For glass thickness	Product no.	Price
	Consisting of:			070054	On request
1050	Drip deflector, straight	25x	6mm	070057	N/A
	Drip deflector, straight	25x	8mm	070053	
970	Drip deflector, curved	10x	6mm	070055	
	Display	1x			N/A

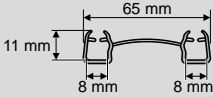
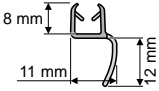
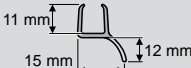
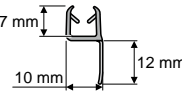
Sealing strip

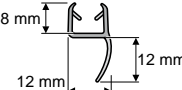
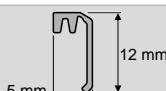
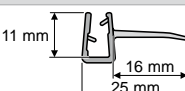
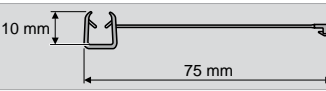
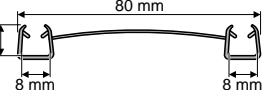
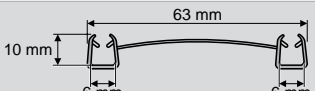
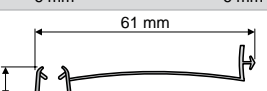
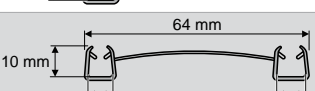
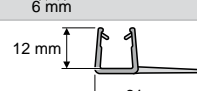

Length	Cross-section	Spare part	For glass thickness	Product no.	Price
1999mm		Sealing strip		070012	62,-
2000mm		Sealing strip	8mm	070013	
2008mm		Sealing strip	6mm	070014	
		Sealing strip	6mm	070015	
2100mm		Sealing strip	6mm	070016	
2010mm		Sealing strip	6mm	070017	
1958mm		Sealing strip	8mm	070018	
1853mm		Sealing strip		070020	
1950mm		Sealing strip	5mm	070021	
1982mm		Sealing strip I	6mm	070022	
2000mm		Sealing strip I	8mm	070023	
1462mm		Sealing strip II	6mm	070024	
2000mm		Sealing strip II	8mm	070025	
1462mm		Sealing strip III	6mm/8mm	070026	
1950mm		Sealing strip	8mm	070027	

ATTENTION: Spare parts are unworked, treatment on site according to original part / sample

Glass thickness of product - please see technical information of the model

Prices plus 6,- Euro freight charges per shipment, where delivered separately.

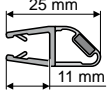
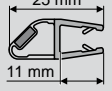
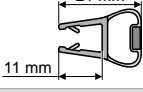
Magnetic strips, O-profiles and sealing strips

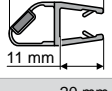
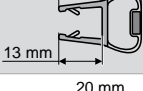
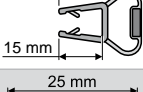
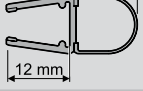
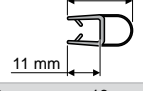
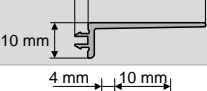
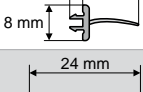
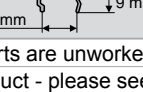
Length	Cross-section	Spare part	For glass thickness	Product no.	Price
2000mm		Magnetic strip 45 degree, door panel fixed left	6mm	070031	62,-
		Magnetic strip 45 degree, door panel fixed right	6mm	070032	
		Magnetic strip	6mm	070033	
2025mm		Magnetic strip 45 degree, door panel fixed left	8mm	070034	
		Magnetic strip 45 degree, door panel fixed right	8mm	070035	
2000mm		Magnetic strip	8mm	070036	
1932mm		Magnetic strip	5mm	070037	
2010mm		O-profile	8mm	070038	
		O-profile	6mm	070039	
1907mm		Vertical sealing strip		070040	
1900mm		Sealing strip glass		070041	
		Sealing strip styrene		070042	

ATTENTION: Spare parts are unworked, treatment on site according to original part / sample

Glass thickness of product - please see technical information of the model

Prices plus 6,- Euro freight charges per shipment, where delivered separately.

Magnetic strips, O-profiles and sealing strips

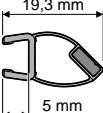
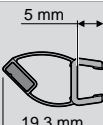
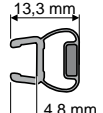
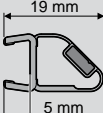
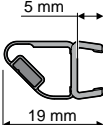
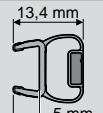
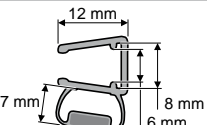
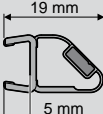
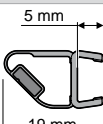
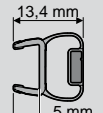
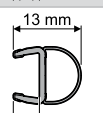
Length	Cross-section	Spare part	For glass thickness	Product no.	Price
2025mm		Magnetic strip 45 degree, door panel fixed left	6mm	070063	62,-
		Magnetic strip 45 degree, door panel fixed right	6mm	070064	
		Magnetic strip	6mm	070065	
		Magnetic strip 45 degree, door panel fixed left	8mm	070066	
		Magnetic strip 45 degree, door panel fixed right	8mm	070067	
		Magnetic strip	8mm	070068	
		Magnetic strip	6/8mm	070069	
		Magnetic strip Left door panel, silver	8mm	070070	
		Magnetic strip Right door panel, silver	8mm	070071	
		Magnetic strip, silver	8mm	070072	
		O-profile	8mm	070073	
			O-profile, silver	8mm	

ATTENTION: Spare parts are unworked, treatment on site according to original part / sample

Glass thickness of product - please see technical information of the model

Prices plus 6,- Euro freight charges per shipment, where delivered separately.

HÜPPE profile cross-sections



How much space is required for attaching the shower enclosure? What is the width of the wall profile?



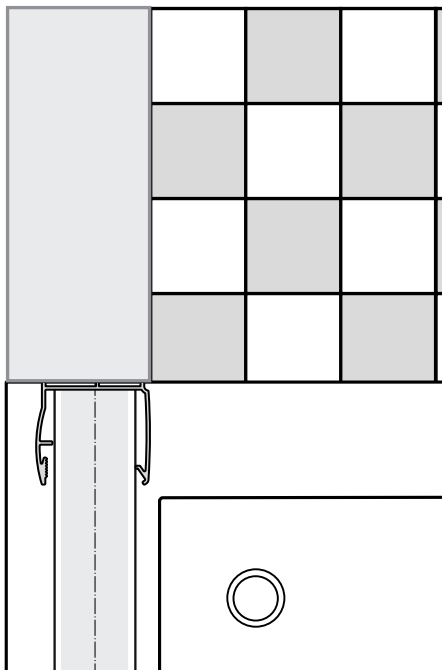

Some of these questions need to be answered at the bathroom planning stage, particularly if the shower enclosure is to be fixed to an internal / extended wall for example.

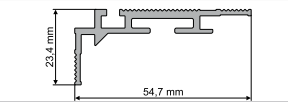
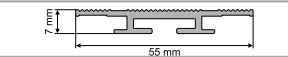
The "Profile cross-sections" overview includes all the important profile cross-sections of the different HÜPPE series with dimensions specified. With this information a bathroom can be designed without making any compromises.

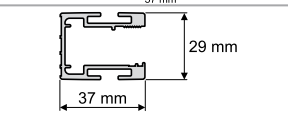
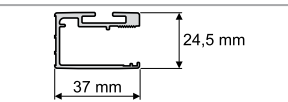
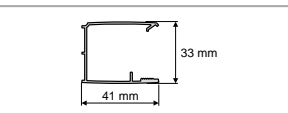
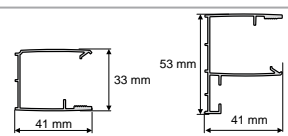
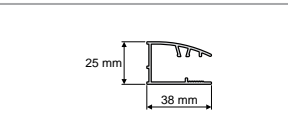
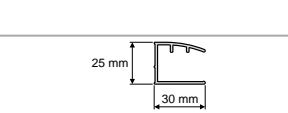
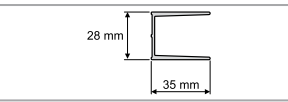
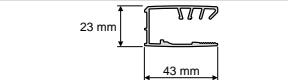
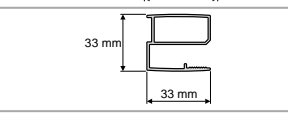
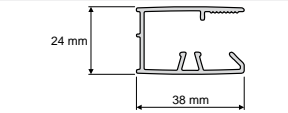
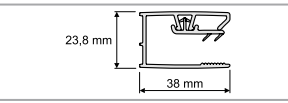
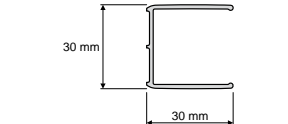
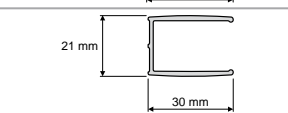
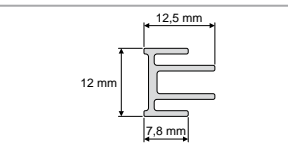
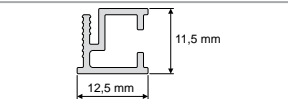

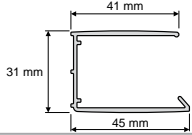
Shape of cross-section

Profile	Serie	
	HÜPPE EasyStyle with Select+	Corner profile, inner
	HÜPPE EasyStyle with Select+	Connecting profile
	HÜPPE EasyStyle with Select+	End profile
	HÜPPE Select+	Wall profile/kit (inside/outside)
	HÜPPE Select+	Wall profile/kit
	HÜPPE Alpha 2	Wall profile
	HÜPPE Classics 2	Wall profile
	HÜPPE Classics 2 EasyEntry	Wall profile fully framed
	HÜPPE Alpha 2	Wall profile fully framed
	HÜPPE Aura elegance swing doors	Wall profile, side panel and fixed panel
	HÜPPE Classics 2 swing doors	Wall profile, side panel and fixed panel
	HÜPPE 501 Design pure swing doors	Wall profile, side panel and fixed panel
	HÜPPE Classics 2 swing doors	Wall profile, fastening side (without fixed segment)
	HÜPPE 501 Design pure swing doors	Wall profile, fastening side (without fixed segment)
	HÜPPE Design elegance swing doors	Wall profile, fastening side (without fixed segment)
	HÜPPE Design elegance/Design pure sliding doors	Wall profile, side panel and fixed panel
	HÜPPE Refresh pure	Wall profile, door and fixed panel
	HÜPPE Design elegance/Design pure swing doors	Wall profile, side panel and fixed panel
	HÜPPE Solva pure partially framed	Wall profile, side panel and fixed panel
	HÜPPE Solva pure partially framed	Wall profile (for door in recess)
	HÜPPE Design pure swing doors	Wall profile, fastening side (without fixed segment)
	HÜPPE Design elegance/Design pure swing doors	Wall profile (for door in recess)
	HÜPPE Solva pure frameless	Wall profile (for door in recess)
	HÜPPE Solva pure frameless	Wall profile hinge side
	HÜPPE Solva pure frameless	Wall profile hinge side

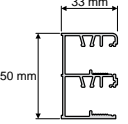
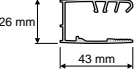
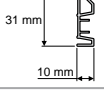
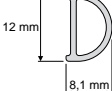
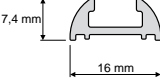
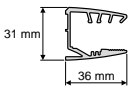
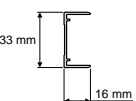
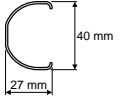
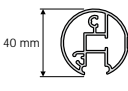
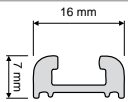
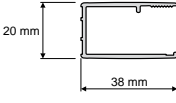
Profile	Serie	
	HÜPPE Solva pure partially framed	Wall profile, fastening side (without fixed segment)
	HÜPPE Enjoy elegance/pure partially framed	Wall profile, side panel and fixed panel
	HÜPPE Enjoy elegance partially framed	Wall profile, fastening side (without fixed segment)
	HÜPPE Enjoy elegance partially framed	Profile connection, two-way door, side panel corner configuration
	HÜPPE Duplo pure	Wall profile
	HÜPPE Vista pure partially framed	Wall profile
	HÜPPE Vista pure partially framed	Wall profile (for door in recess)
	HÜPPE Studio Paris elegance frameless	Wall profile hinge side
	HÜPPE Studio Berlin pure frameless	Wall profile hinge side
	HÜPPE Studio Paris elegance frameless	Wall profile (for door in recess)
	HÜPPE Studio Berlin pure frameless	Wall profile (for door in recess)
	HÜPPE Studio Paris elegance partially framed	Wall profile, side panel and fixed panel
	HÜPPE Studio Berlin pure partially framed	Wall profile, side panel and fixed panel
	HÜPPE Studio Paris elegance partially framed	Wall profile, fastening side (without fixed segment)
	HÜPPE Studio Berlin pure partially framed	Wall profile, fastening side (without fixed segment)
	HÜPPE Studio Paris elegance partially framed	Cover profile, fastening side
	HÜPPE Studio Berlin pure partially framed	Cover profile, fastening side
	HÜPPE Studio Paris elegance partially framed	Design profile
	HÜPPE Studio Berlin pure partially framed	Design profile
	HÜPPE Xtensa pure	Wall profile (for door in recess)
	HÜPPE Xtensa pure	Wall profile, side panel
	HÜPPE Xtensa pure	Xtensa SlimLine wall profile

HÜPPE GmbH
Industriestraße 3
D-26160 Bad Zwischenahn
Germany
Tel.: +49 44 03/67-425 or -435,
Fax: +49 44 03/67-145

hueppe@hueppe.com
www.hueppe.com

Our General Business Conditions apply (see www.hueppe.com). Goods and advice available from your bathroom retailer. We reserve the right to make technical changes and colour variations.

Our products have won numerous awards – including international design awards from **red dot**, **Interior Innovation**, **Plus X**, **iF** and the **German Design Award**. These distinctions have one thing in common - they are coveted, very highly recognised international awards, granted by renowned, independent juries. All confirm the high quality and innovative design of our products.



HÜPPE
SHOWER AND SOUL